

AlphoL2

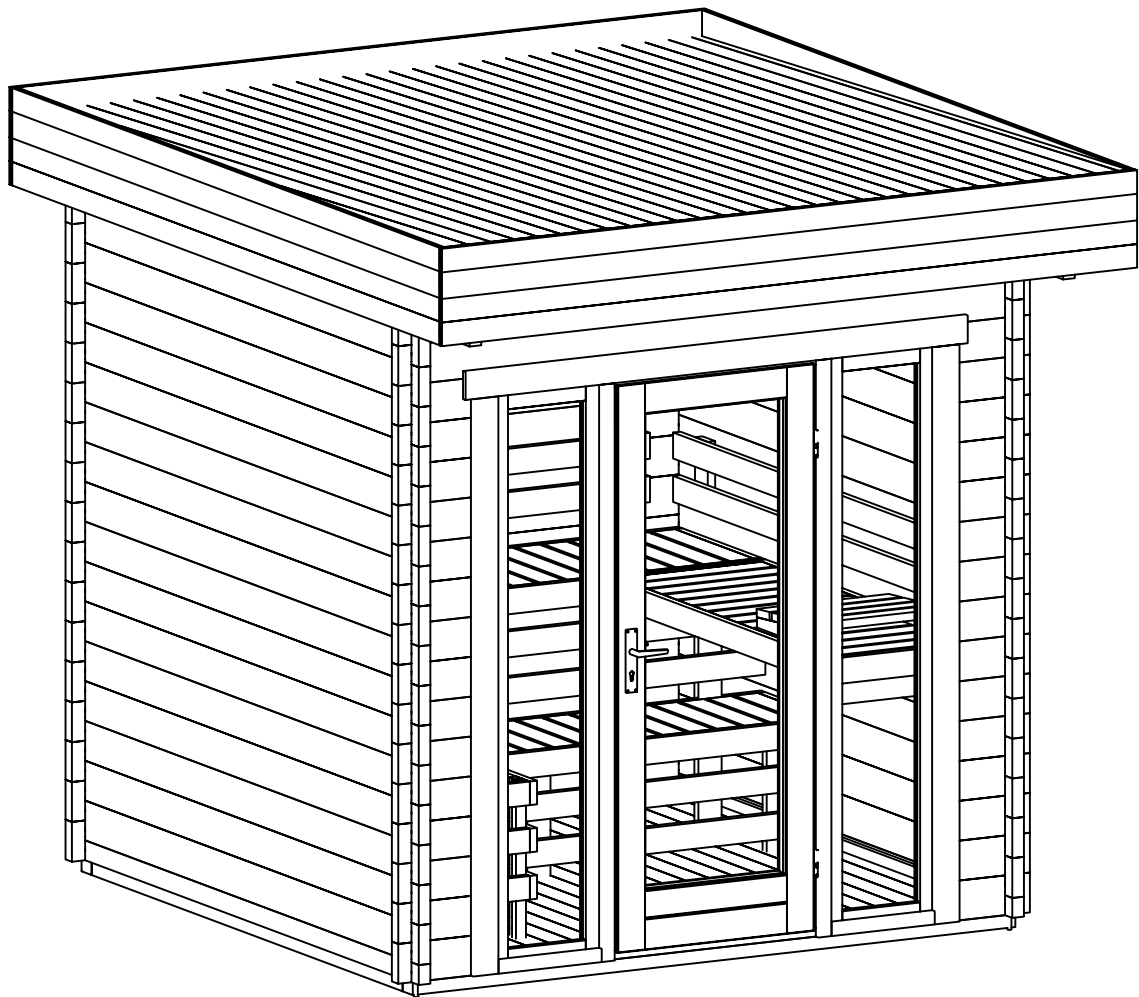

Sauna Lupo 44

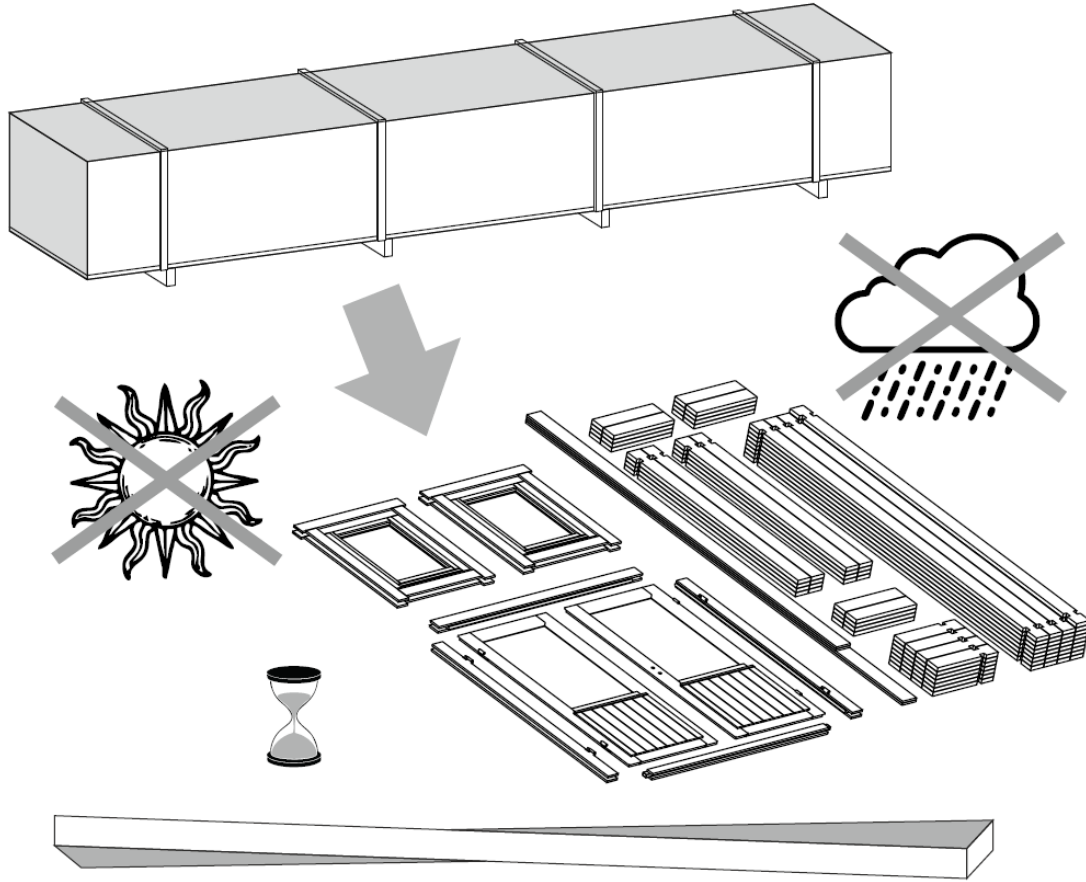

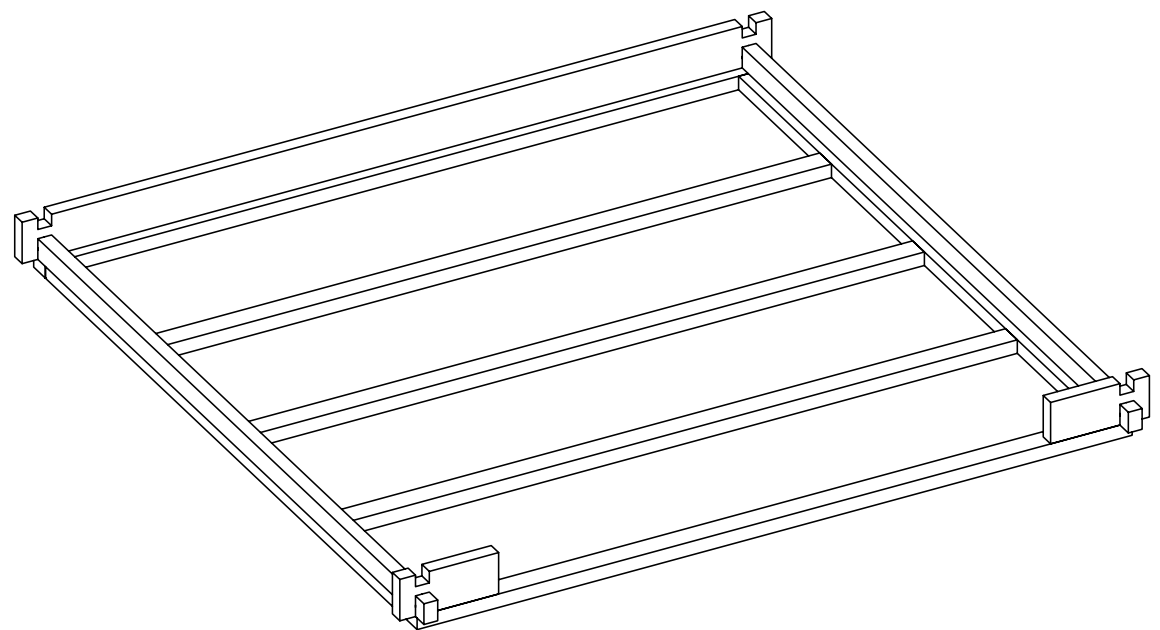
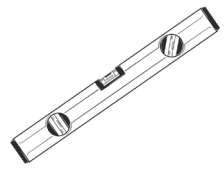
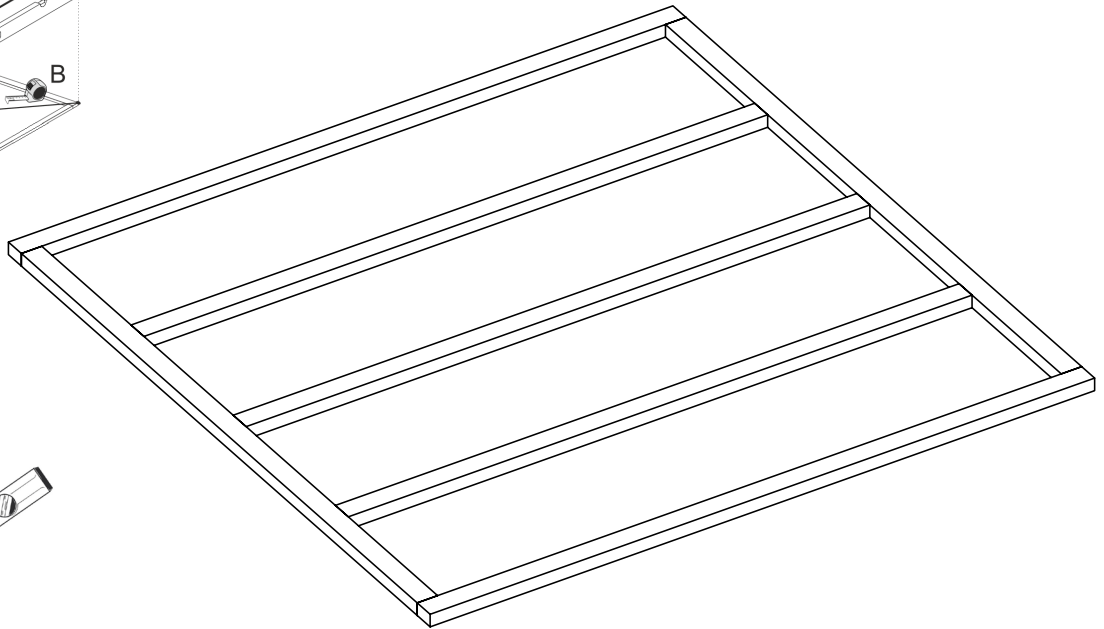
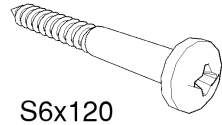
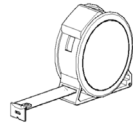
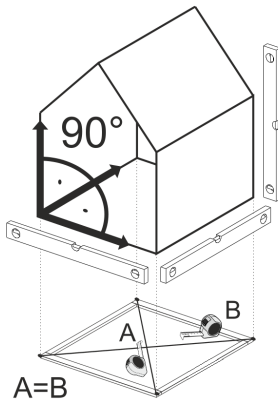

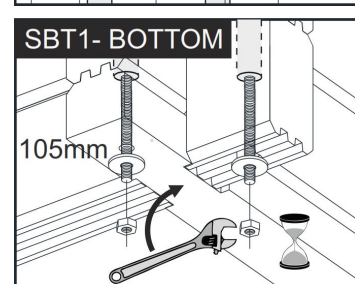
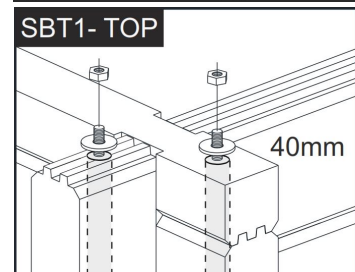
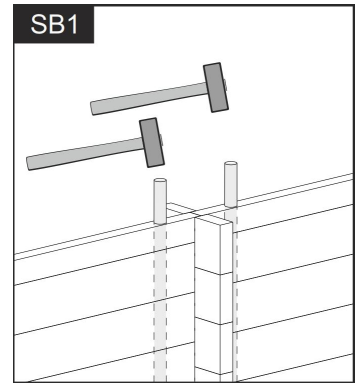
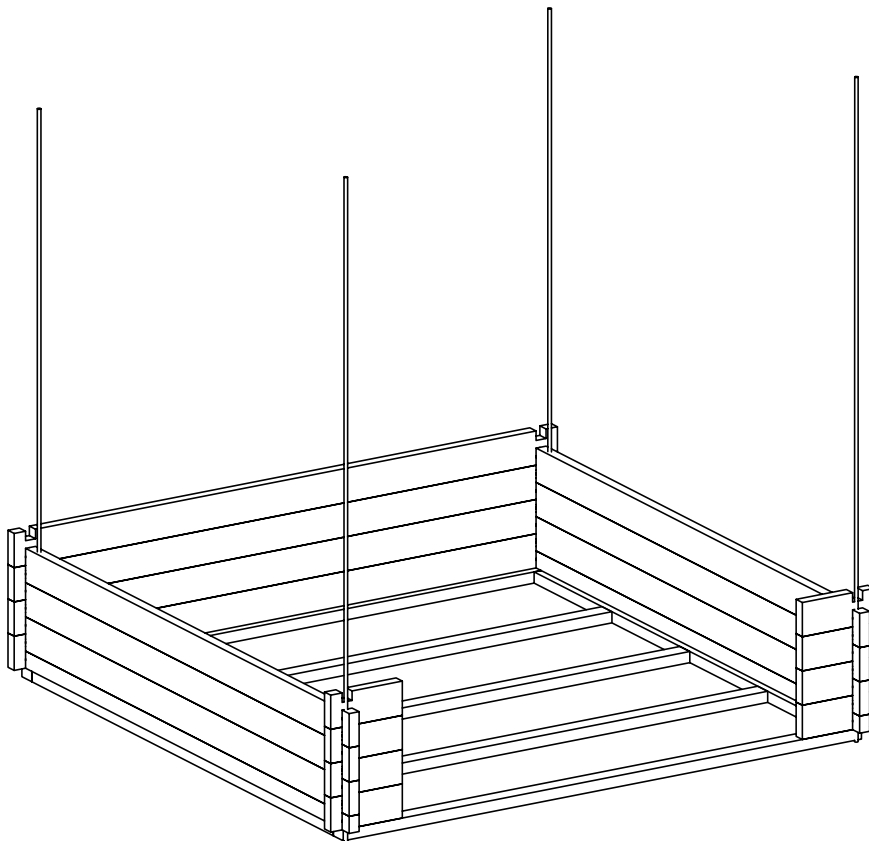
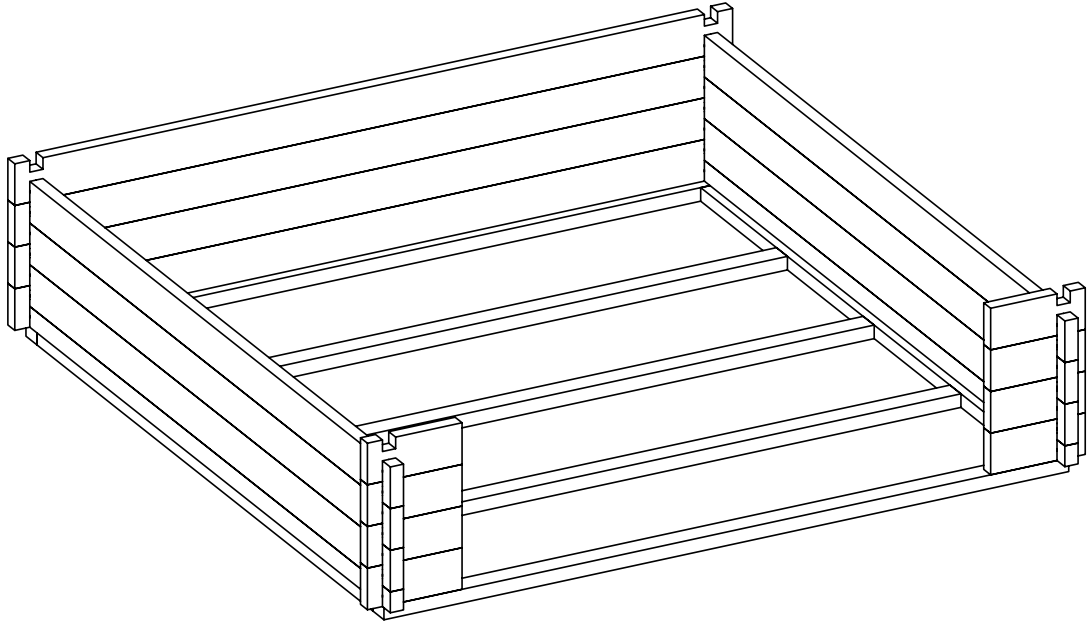



Bitte beachten Sie den Anhang am Ende der Anleitung.
Please refer to the appendix of this section.

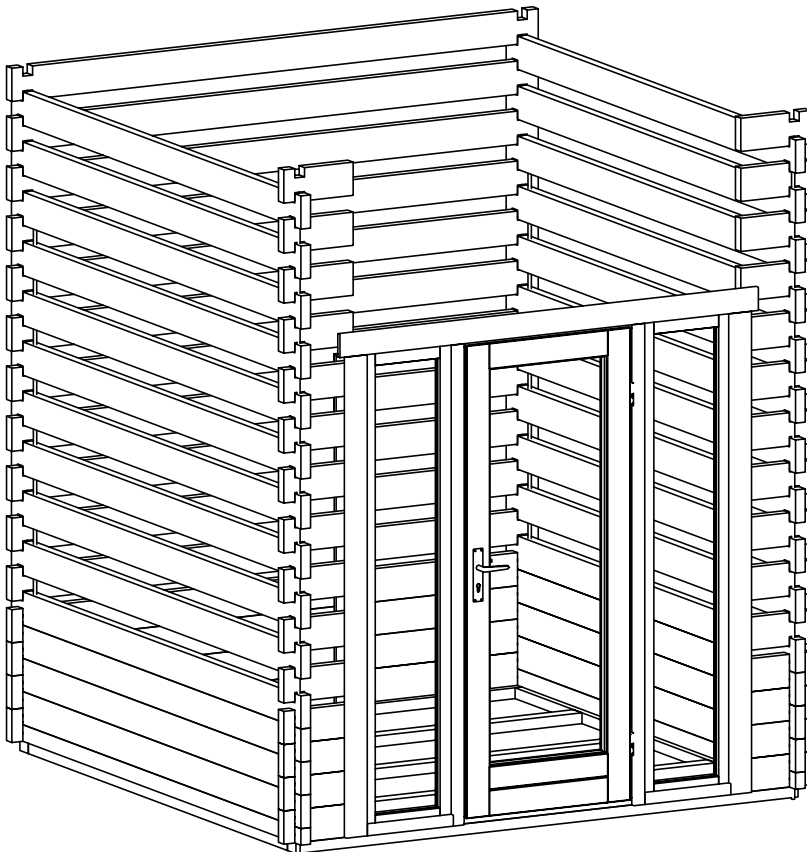
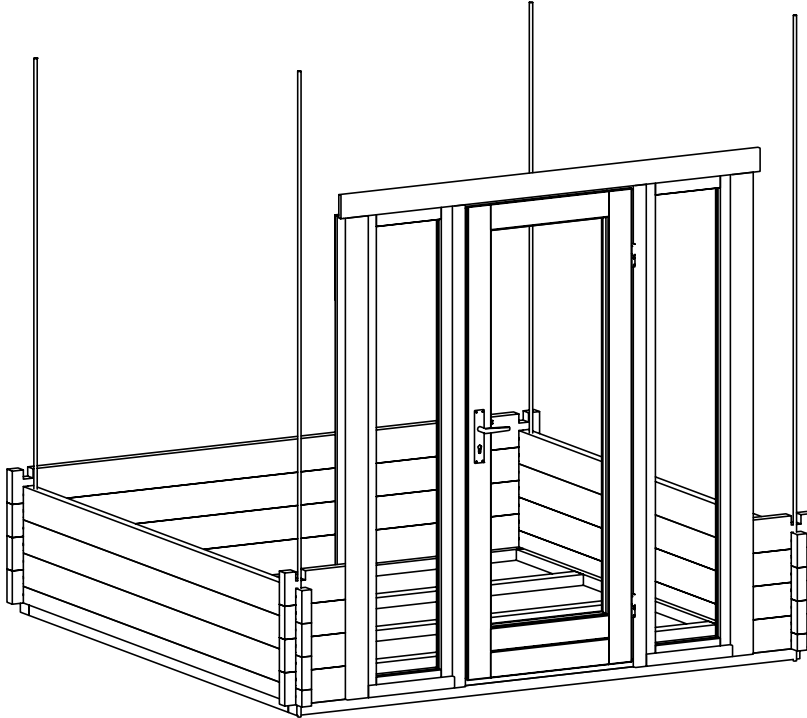

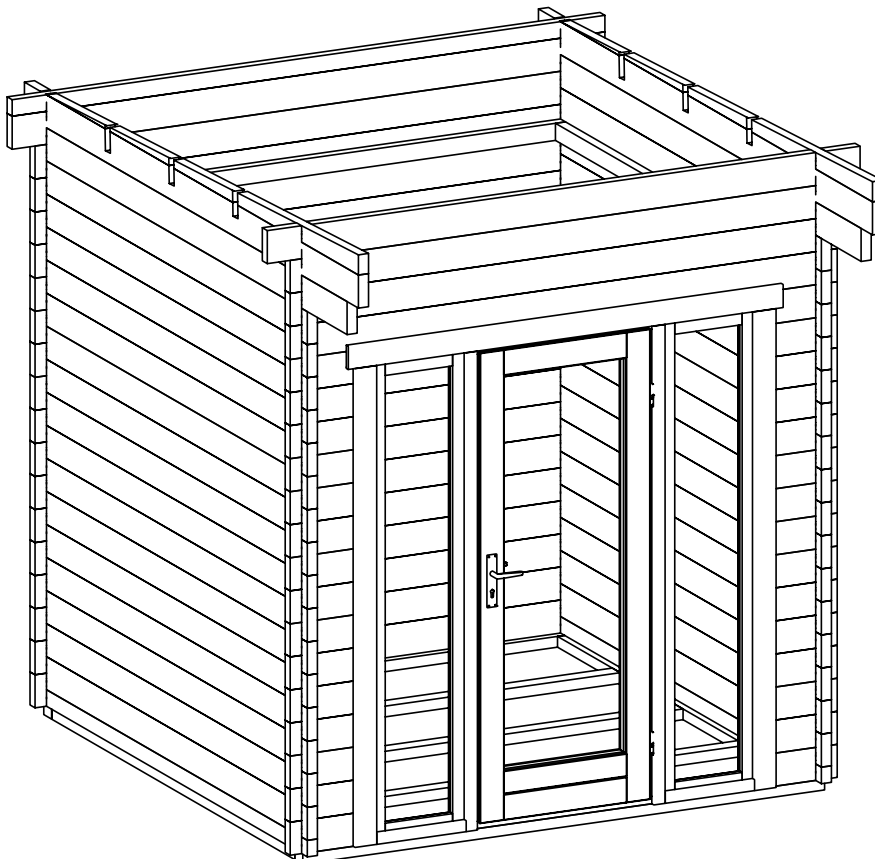
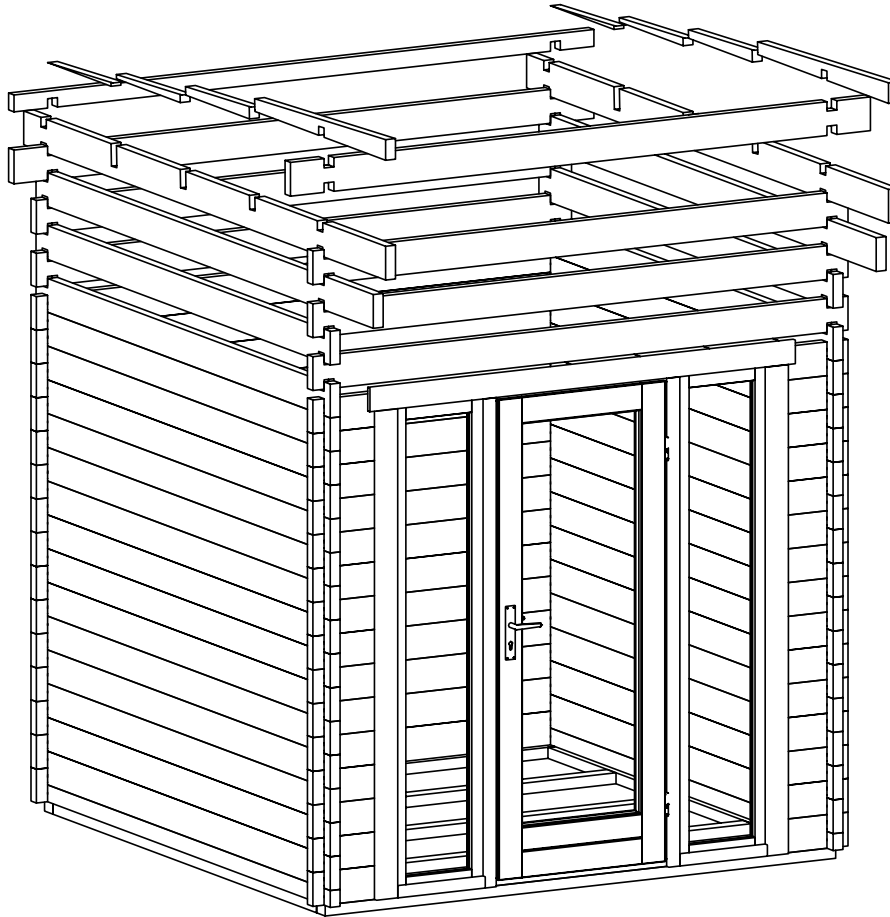

4

Bitte beachten Sie den Anhang am Ende der Anleitung.
Please refer to the appendix of this section.

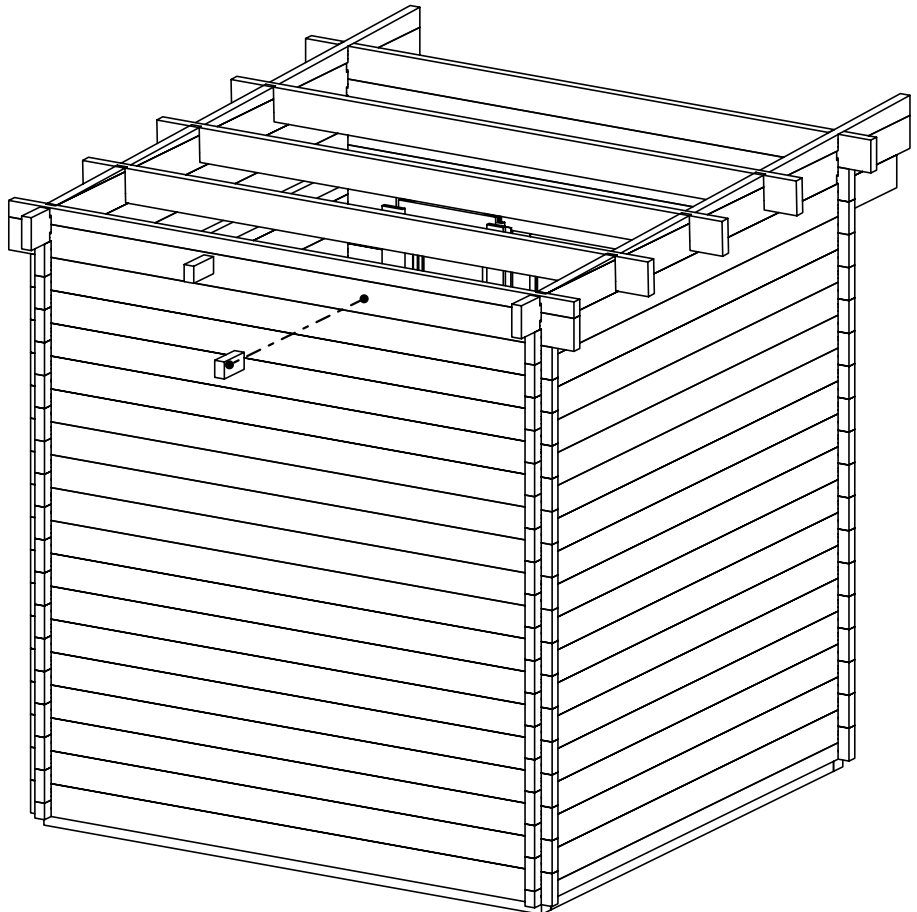
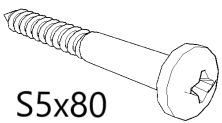
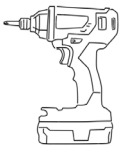
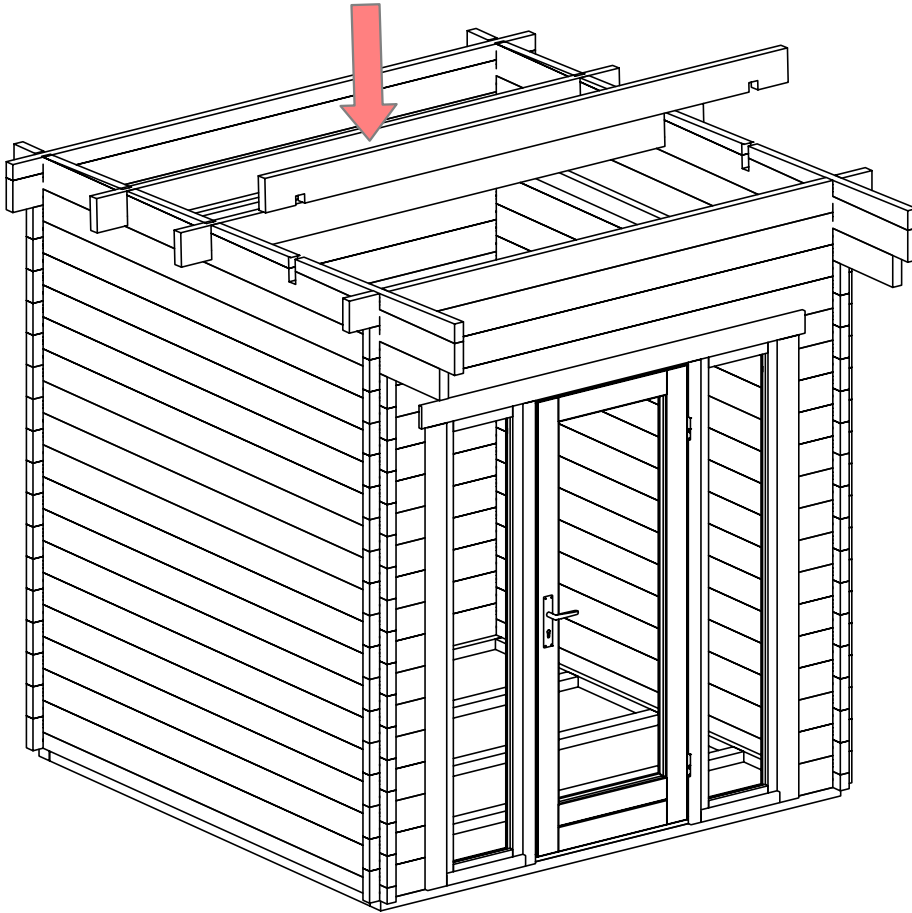

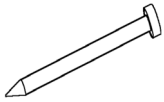
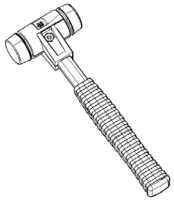

N1,8x40

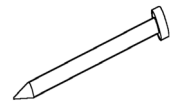
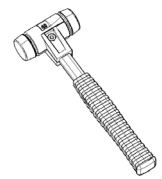
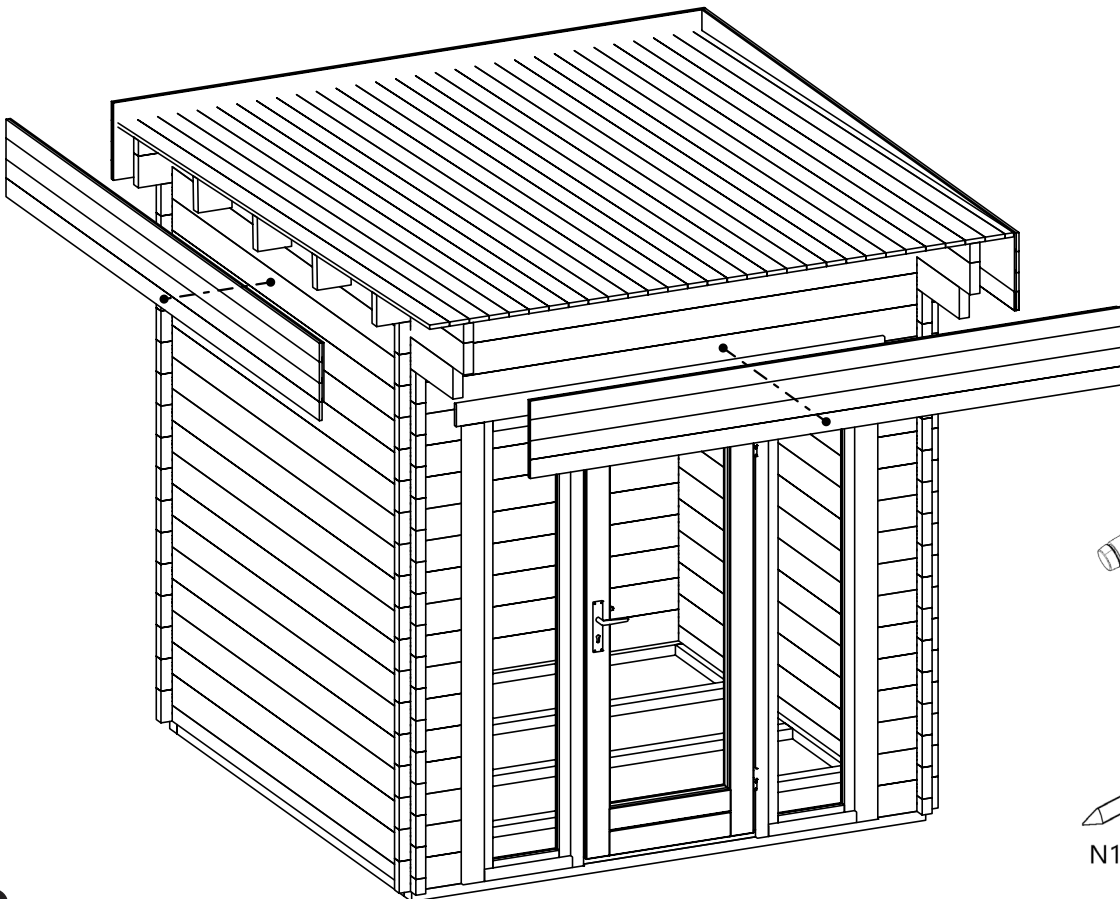
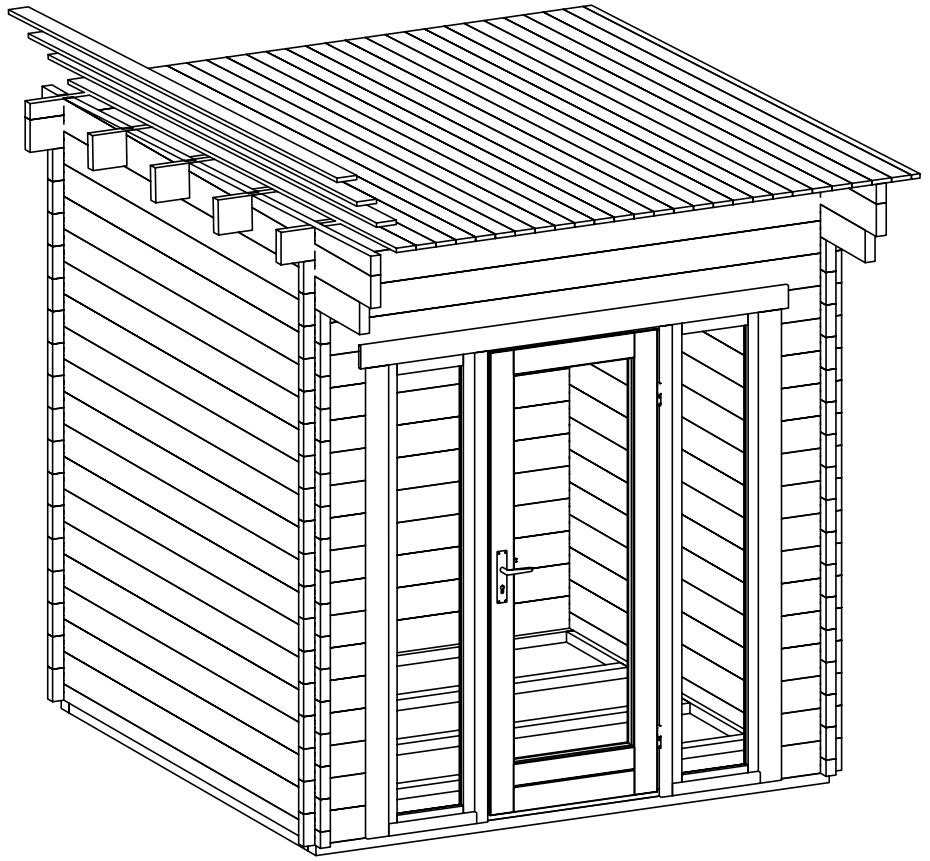

N1,8x40

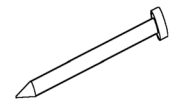
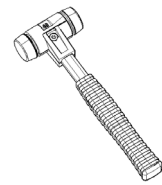
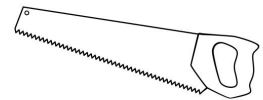
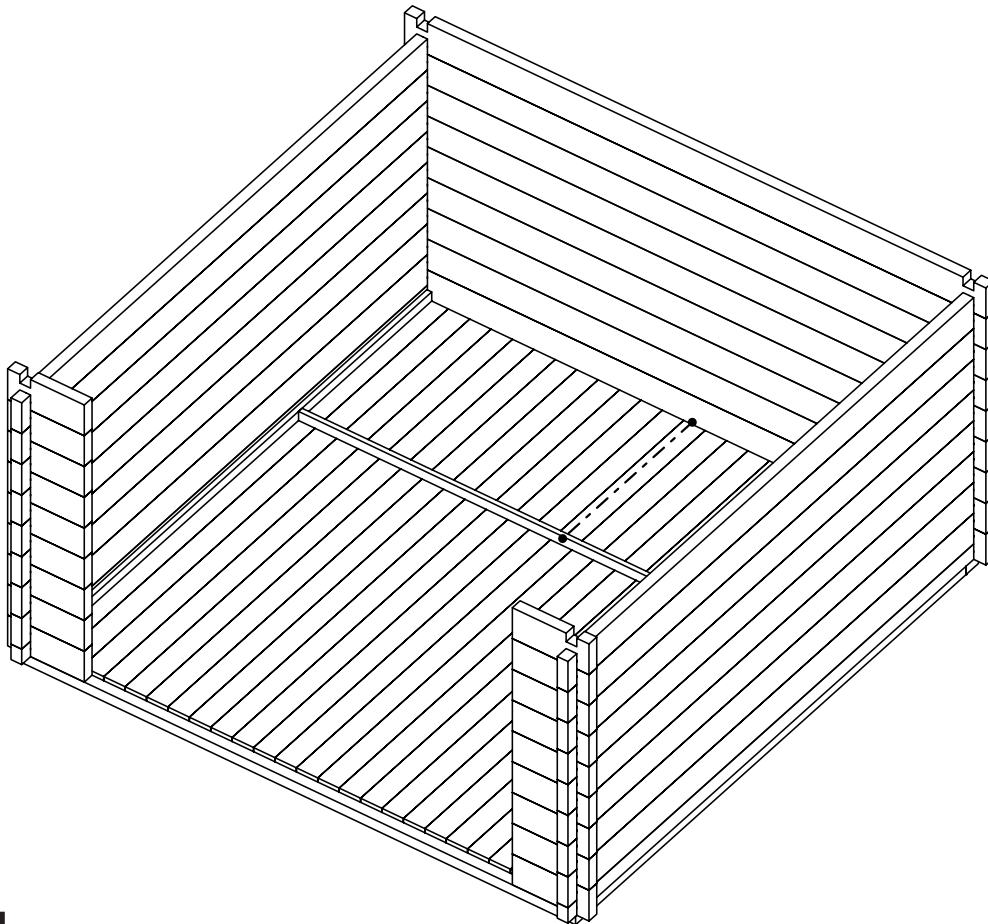
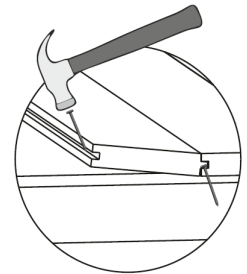
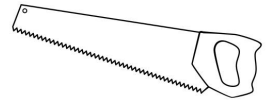
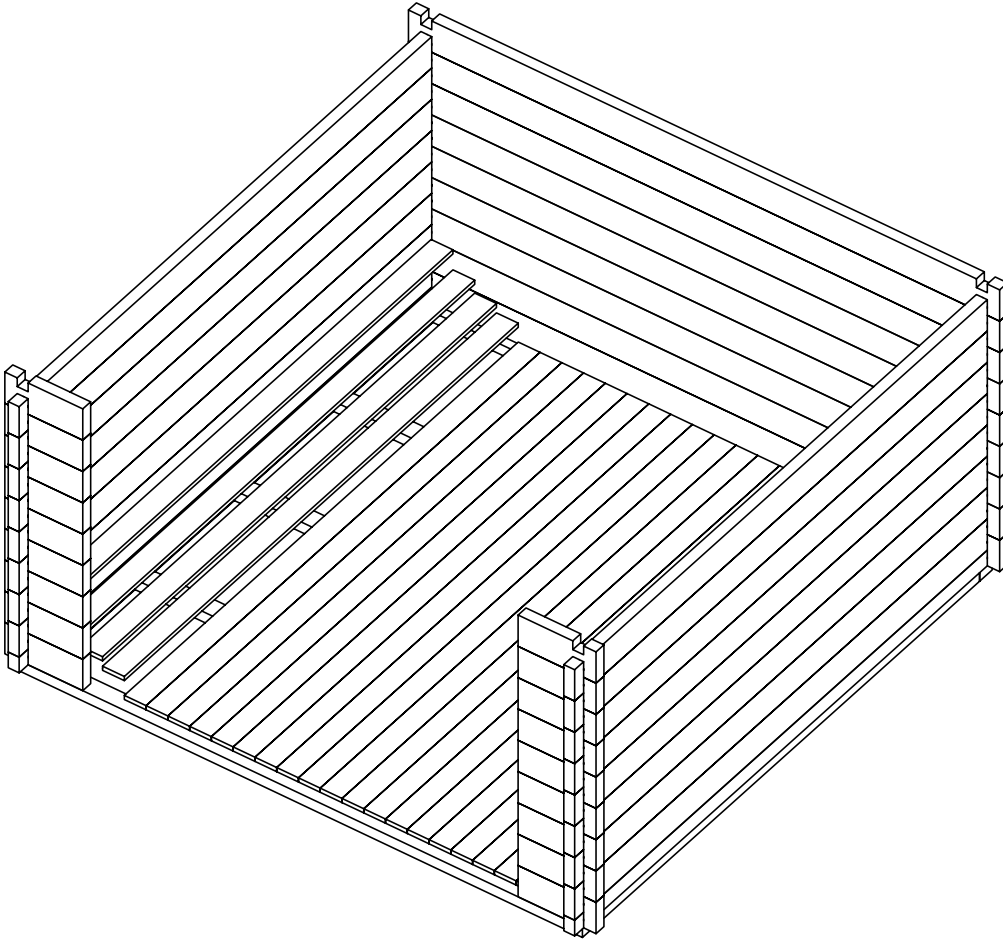

N1,8x40

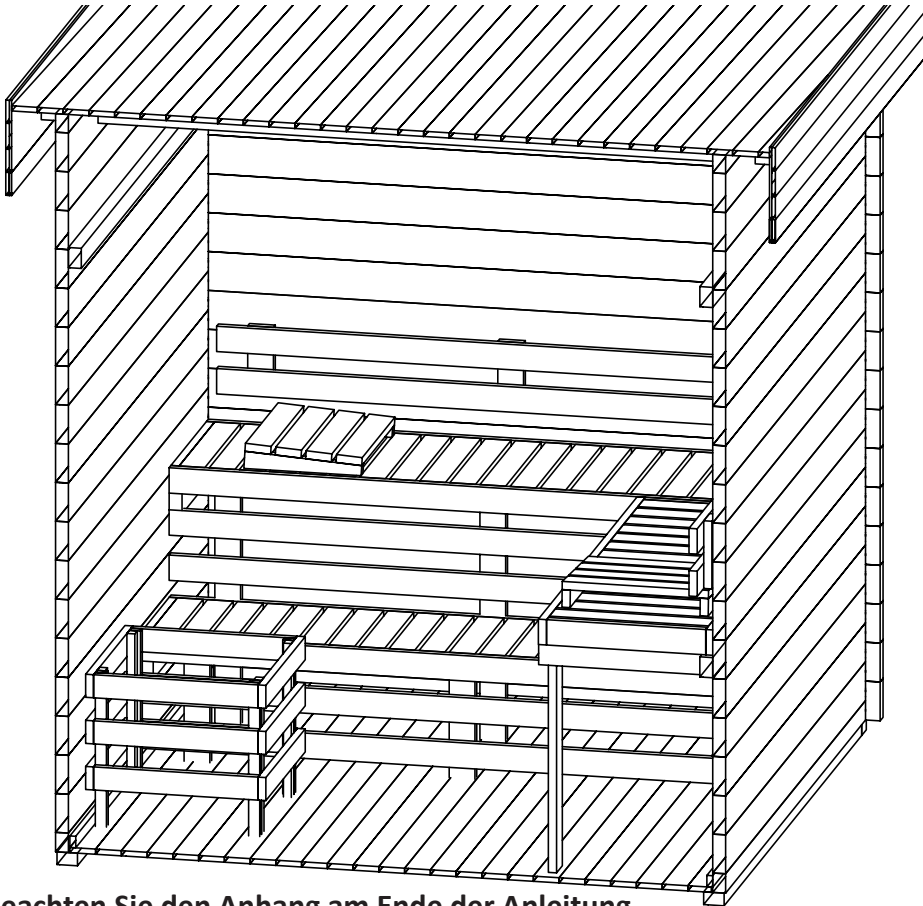

Bitte beachten Sie den Anhang am Ende der Anleitung.
Please refer to the appendix of this section.

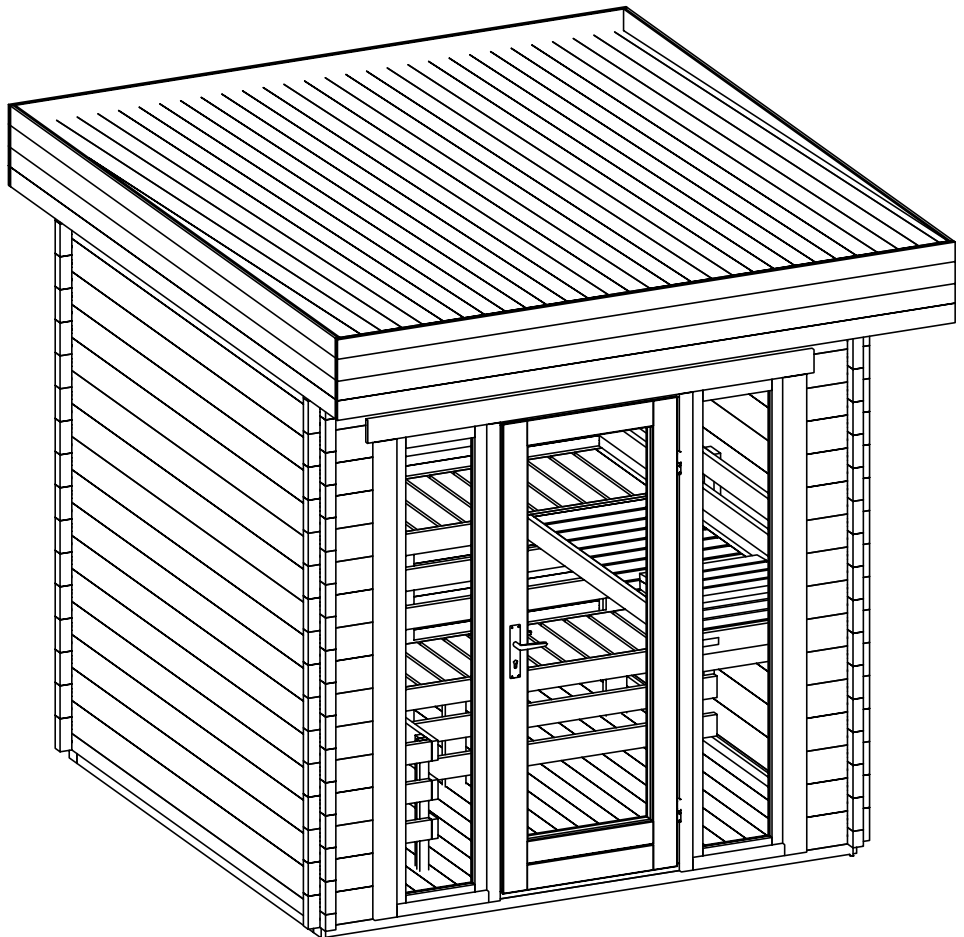
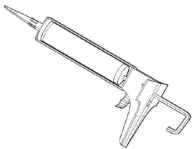
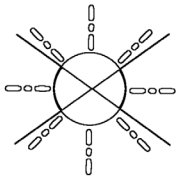

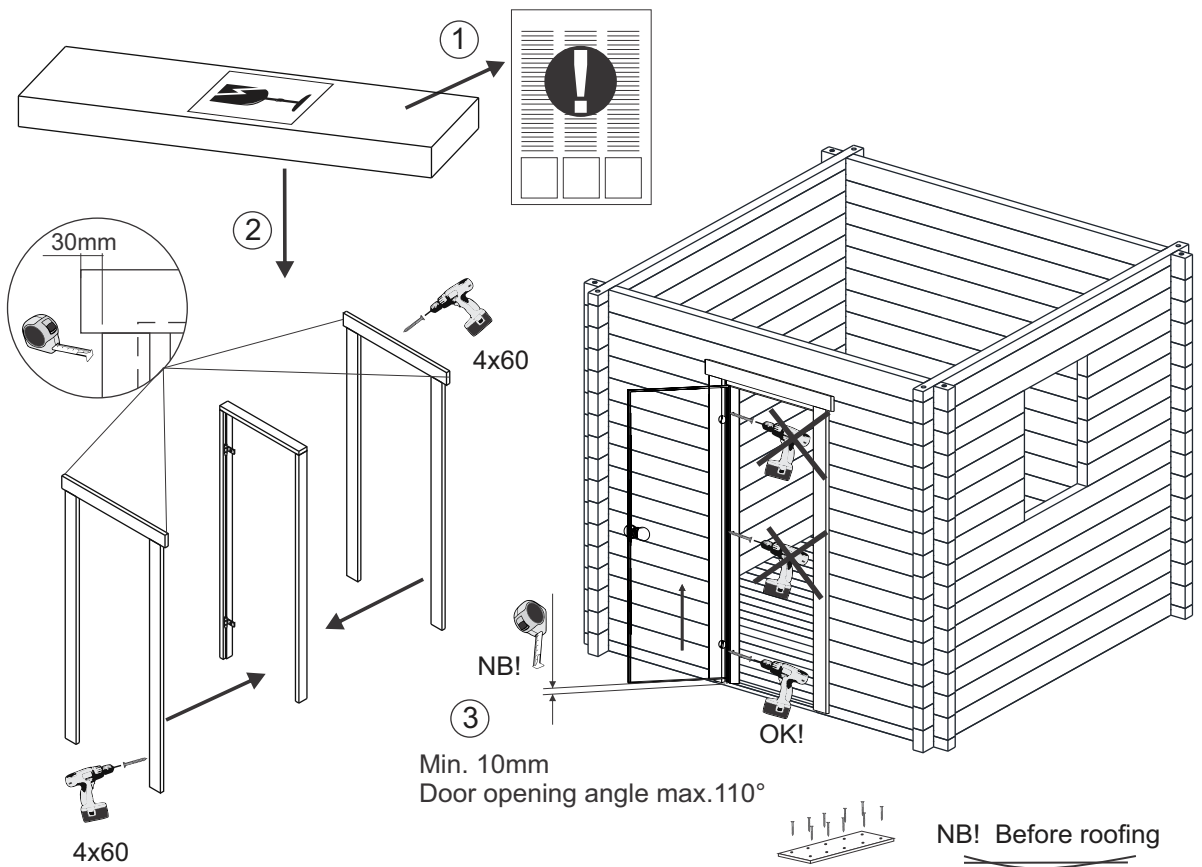





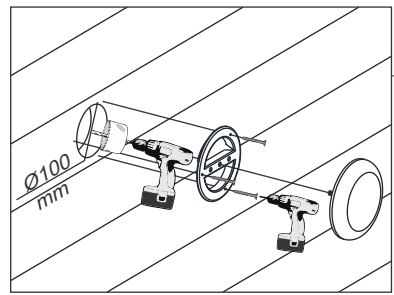



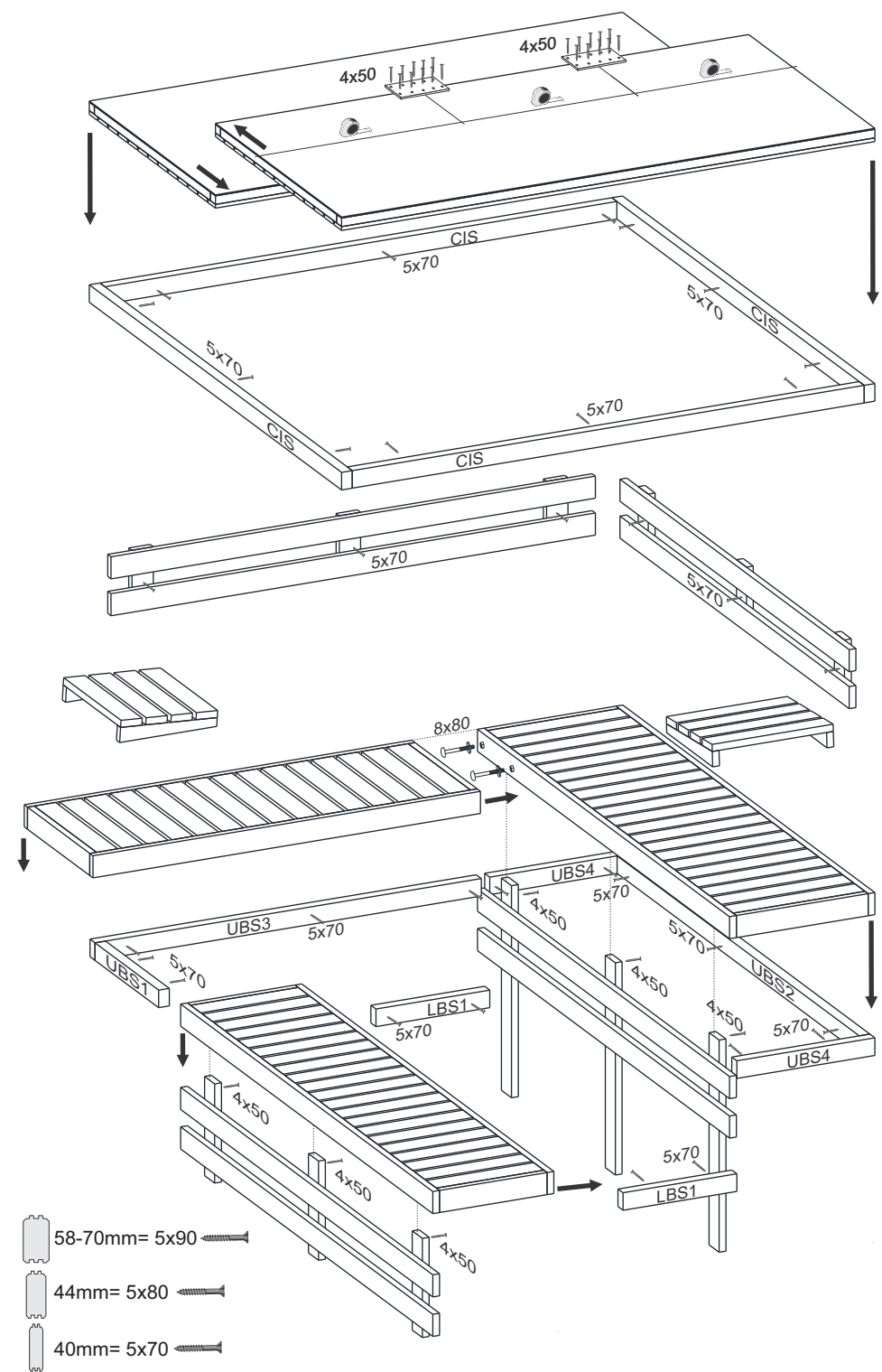
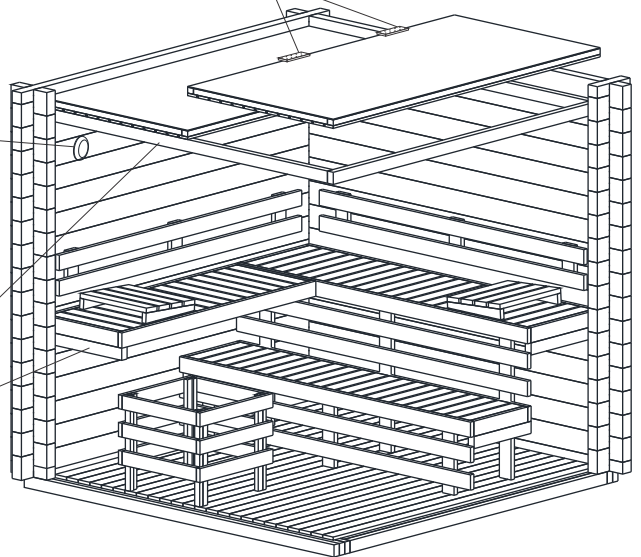

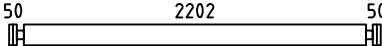
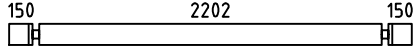
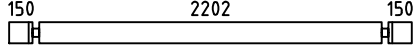
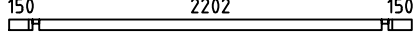
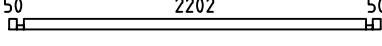
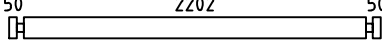
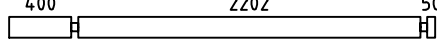
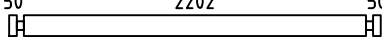
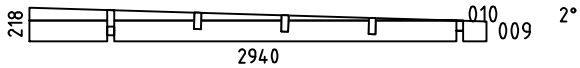
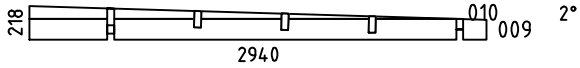

Min. 10mm
Door opening angle max. 110°

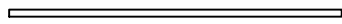

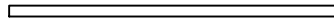
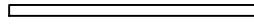





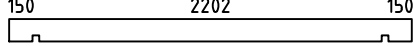
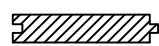





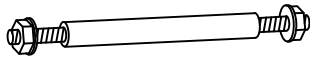

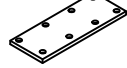
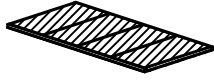
NB! Before roofing

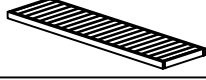



- 58-70mm = 5x90
- 44mm = 5x80
- 40mm = 5x70

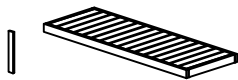
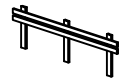
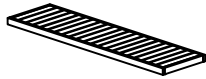

Pos	Specification-Spezifikation-Specificatie-Nomenclature-Elementi-Especificacion SaunaLupoa44	Qty	Profile (mm)	Lenght (mm)
001	50 221 	30	44x135	315
002	50 2202 50 	20	44x135	2390
003	150 2202 150 	1	44x135	2590
004	150 2202 150 	1	44x135	2590
005	150 2202 150 	1	44x68	2590
006	50 2202 50 	2	44x68	2390
007	50 2202 50 	32	44x135	2390
008	400 2202 50 	2	44x135	2740
EXTRA	50 2202 50 	1	44x135	2390
WA-1		1		
WB-1		1		
F2	FOUNDATION-FUNDAMENT-FONDATION-FONDAZIONE-VIGAS DE CIMENTACIÓN 	2	70x44	2280
F1	FOUNDATION-FUNDAMENT-FONDATION-FONDAZIONE-VIGAS DE CIMENTACIÓN 	5	70x44	2140
CS1	CORNICE SUPPORT-TRAGELEISTE-STEUNEN BAR-SUPPORT-SUPPORTO-SOPORTE 	2	44x70	150
UBS2	UPPER BENCH SUPPORT-TRAGELEISTE-STEUNEN BAR-SUPPORT-SUPPORTO-SOPORTE 	1	44x70	2106
UBS3	UPPER BENCH SUPPORT-TRAGELEISTE-STEUNEN BAR-SUPPORT-SUPPORTO-SOPORTE 	1	44x70	1597
UBS4	UPPER BENCH SUPPORT-TRAGELEISTE-STEUNEN BAR-SUPPORT-SUPPORTO-SOPORTE 	1	44x70	570
UBS1	UPPER BENCH SUPPORT-TRAGELEISTE-STEUNEN BAR-SUPPORT-SUPPORTO-SOPORTE 	1	44x70	555
LBS1	LOWER BENCH SUPPORT-TRAGELEISTE-STEUNEN BAR-SUPPORT-SUPPORTO-SOPORTE 	2	44x70	470
CIS2	CEILING INSULATION SUPPORT-TRAGELEISTE-STEUNEN BAR-SUPPORT-SUPPORTO-SOPORTE 	2	44x70	2202
CIS1	CEILING INSULATION SUPPORT-TRAGELEISTE-STEUNEN BAR-SUPPORT-SUPPORTO-SOPORTE 	2	44x70	2114
PL1	150 PURLIN-DAKBALK-DACHPFETTE-PANNE-ARCARECCIO-CORREA 2202 150 	3	44x144	2590
F-1	Floor board-Fussbodenbrett-Vloerplank-Lame de plancher-Tavola pavimento-Tabla de suelo 	25 20	88x18 114x18	2192
Model	Sauna Lupoa 44	Material	Page 1/3	

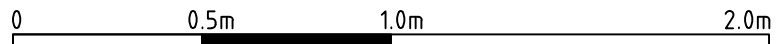
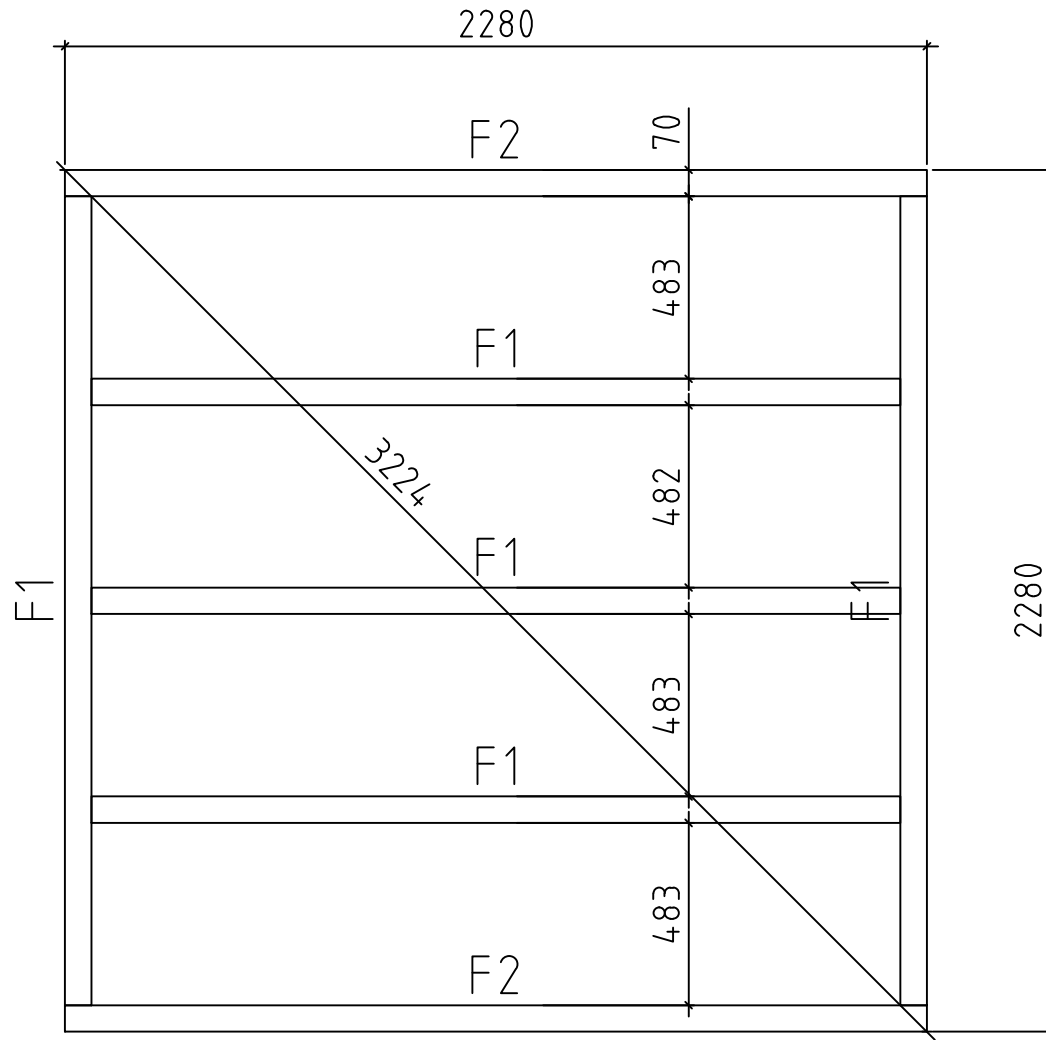
Pos	Specification-Spezifikation-Specificatie-Nomenclature-Elementi-Especificacion SaunaLupoa44	Qty	Profile (mm)	Lenght (mm)	
R-1	Roof board-Dachbrett-Dakplank-Volige-Tavola tetto-Tabla de tejado		30+1	88x18	2940
			24+1	114x18	
CO-1	Cornice 20x250-Gesimse-Kroonlijst-Corniche-Cornicione-Cornisa		2	20x250	2630
CO-2	Cornice 20x250-Gesimse-Kroonlijst-Corniche-Cornicione-Cornisa		2	20x250	2956
FLB-1	Floor beading 3000-Fussbodenleiste-Plinten-Moulure de finition-Listello pavimento-Liston de suelo		4	18x40	12 rmt
TSB1	Threaded steel bar kit-Gewindestange satz-Draadstang set-Kit de tiges filetées-Kit barra filettata-Kit barra roscada		2	Ø14	2610
TSB2	Threaded steel bar kit-Gewindestange satz-Draadstang set-Kit de tiges filetées-Kit barra filettata-Kit barra roscada		2	Ø14	2540
	Backrest-Rückenlehne-Rugleuning-Dossier-Schienale-Respaldo		2	235x2000	
	Bracket 140x40-Lochplatte-Gatenplaat-Connecteur métallique-Piastre forate-Placas perforadas		2	140x40	
CI	Ceiling Insulation-Deckelsolation-Plafondisolatie-Isolation du plafond-Isolamento del soffitto-Aislamiento de techo		2	2190x1095	
	Headrest-Kopfstütze-Hoofdsteun-Appui-tête-Poggiatesta-Reposacabezas		2	395x395	
	Heater guard-Heizungsschutz-Verwarmingsbescherming-Protection de radiateur-Protezione del riscaldatore-Protector de calentador		1	562x602	
	Lower Bench-Untere Bank-Onderbank-Banc inférieur-Banco inferiore-Banco inferior		1	500x2200	
	Lower bench face-Bank unterstützung-Bankje ondersteuning-Dossier banc-Banco schienale-Banco respaldo		1	395x2200	
	Nail 1.8x40-Nagel-Spijker-Clou-Chiodo-Clavo		300	1.8x40	
R8x80	Round head bolt kit 8x80-Schloßschraube-Slotbout-Boulon tête ronde-Bulloni testa tonda-Tornillo cabeza redonda		2	8x80	
	Sauna door kit-Sauna tür satz-Sauna deur set-Kit porte sauna-Kit sauna porta-Kit para sauna puerta		1		
	Sauna ventilation kit-Außengitter-Schoepenrooster-Panneau de ventilation-Griglia di ventilazione-Rejilla de ventilacion		1		
S4x50	Screw 4x50-Schraube-Schroef-Vis-Vite-Tornillo		40	4x50	
S5x80	Screw 5x80-Schraube-Schroef-Vis-Vite-Tornillo		40	5x80	
S6x120	Screw 6x120-Schraube-Schroef-Vis-Vite-Tornillo		20	6x120	
	Upper bench 2-Obere Bank-Bovenbank-Banc supérieur-Banco superiore-Banco superior		1	600x1500	
	Upper bench face-Bank unterstützung-Bankje ondersteuning-Dossier banc-Banco schienale-Banco respaldo		1	845x2200	
	Upper bench-Obere Bank-Bovenbank-Banc supérieur-Banco superiore-Banco superior		1	600x2200	
Model	Sauna Lupoa 44	Material	Page	2/3	



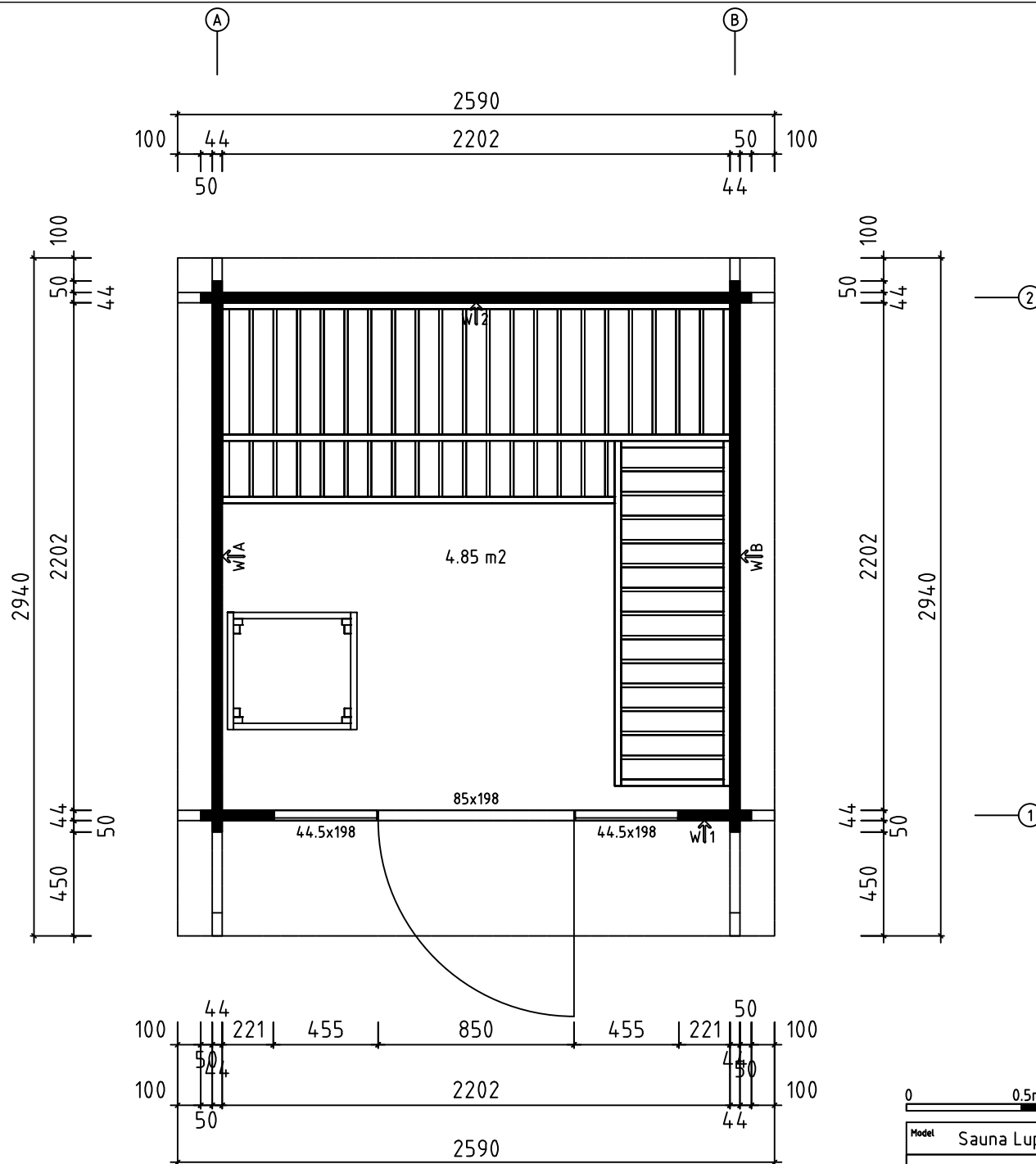

Model	Sauna Lupoa 44	Drawing	FOUNDATION	Page
	Drawn by	J.S	Material	44x135
	Date	29.10.2024	File	Sauna Lupoa 44.dwg
				Scale 1:20

H = 1.600 m
TOTAL: 4.85 m²

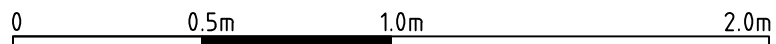
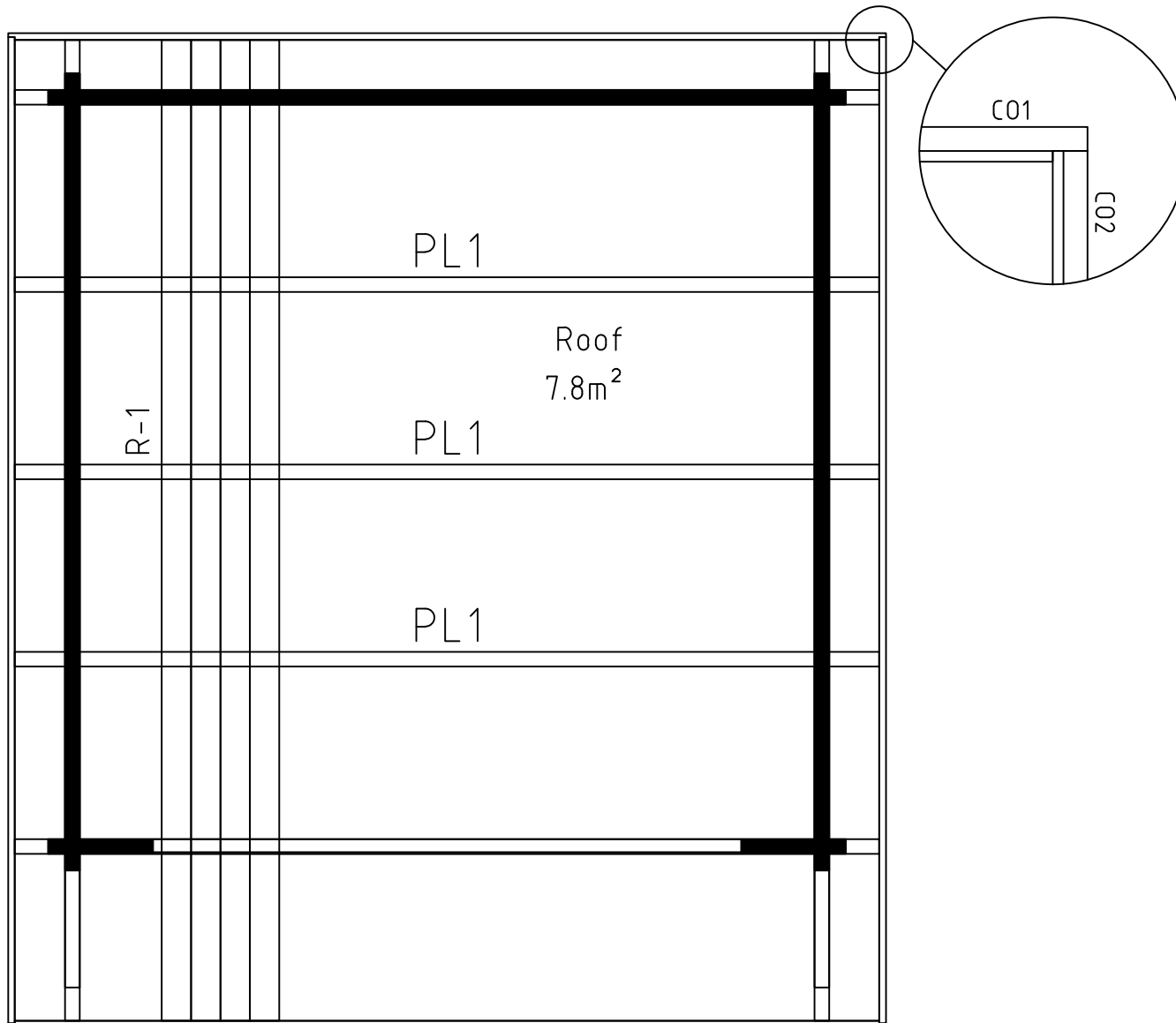

Model	Sauna Lupoa 44	Drawing	PLAN	Page	
		Drawn by	J.S	Material	44x135
		Date	29.10.2024	File	Sauna Lupoa 44.dwg
			Scale	1:20	



Model	Sauna Lupo 44	Drawing	ROOF	Page	
	Drawn by	J.S	Material	44x135	Scale
	Date	29.10.2024	File	Sauna Lupo 44.dwg	

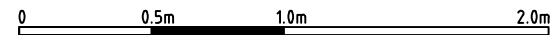
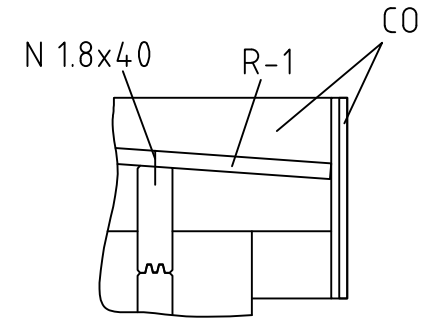
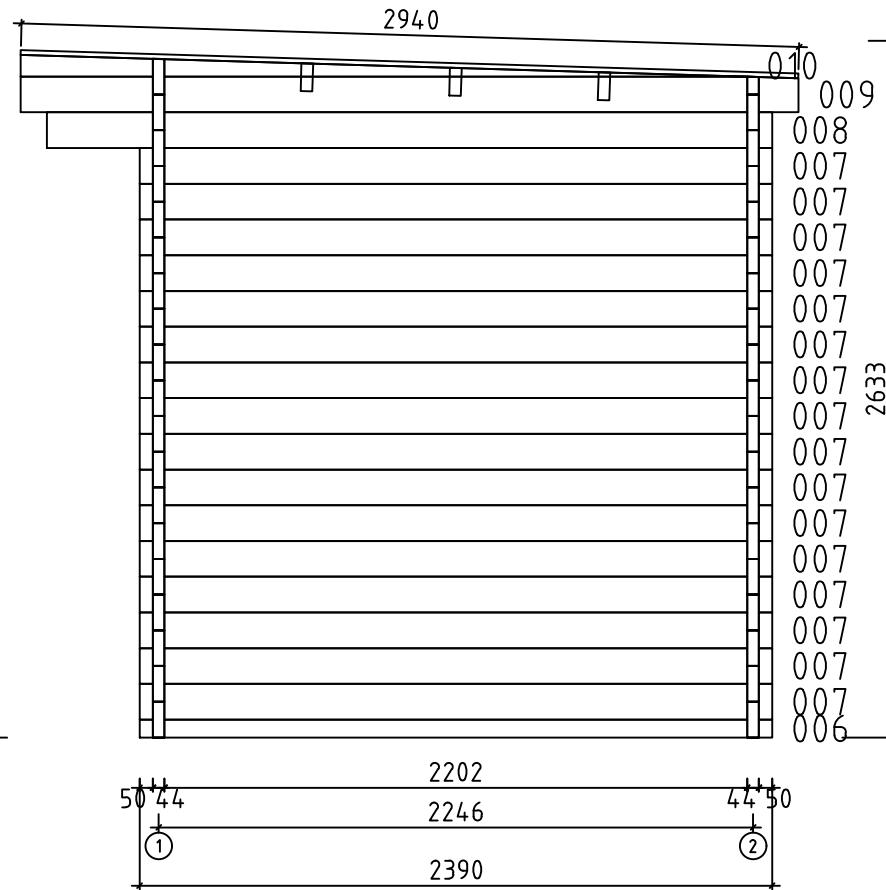
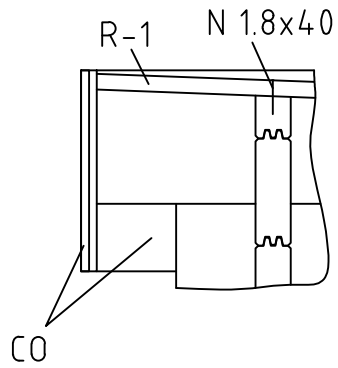

Model	Sauna Lupoa 44	Drawing	WALL A	Page	3
		Drawn by	J.S	Material	4.4x13.5
		Date	29.10.2024	File	Sauna Lupoa 44.dwg
		Scale	1:20		

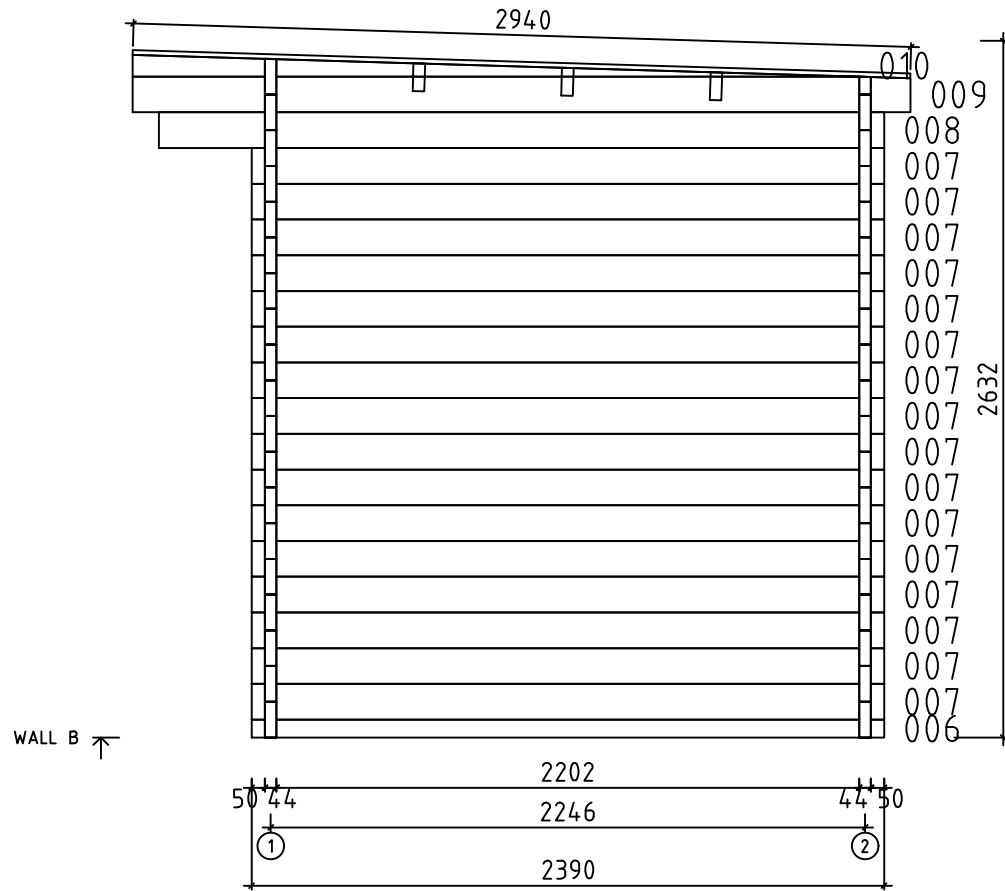

0 0.5m 1.0m 2.0m

Model	Sauna Lupo 44	Drawing	WALL B	Page	4
		Drawn by	J.S	Material	4.4x13.5
		Date	29.10.2024	File	Sauna Lupo 44.dwg
		Scale	1:20		

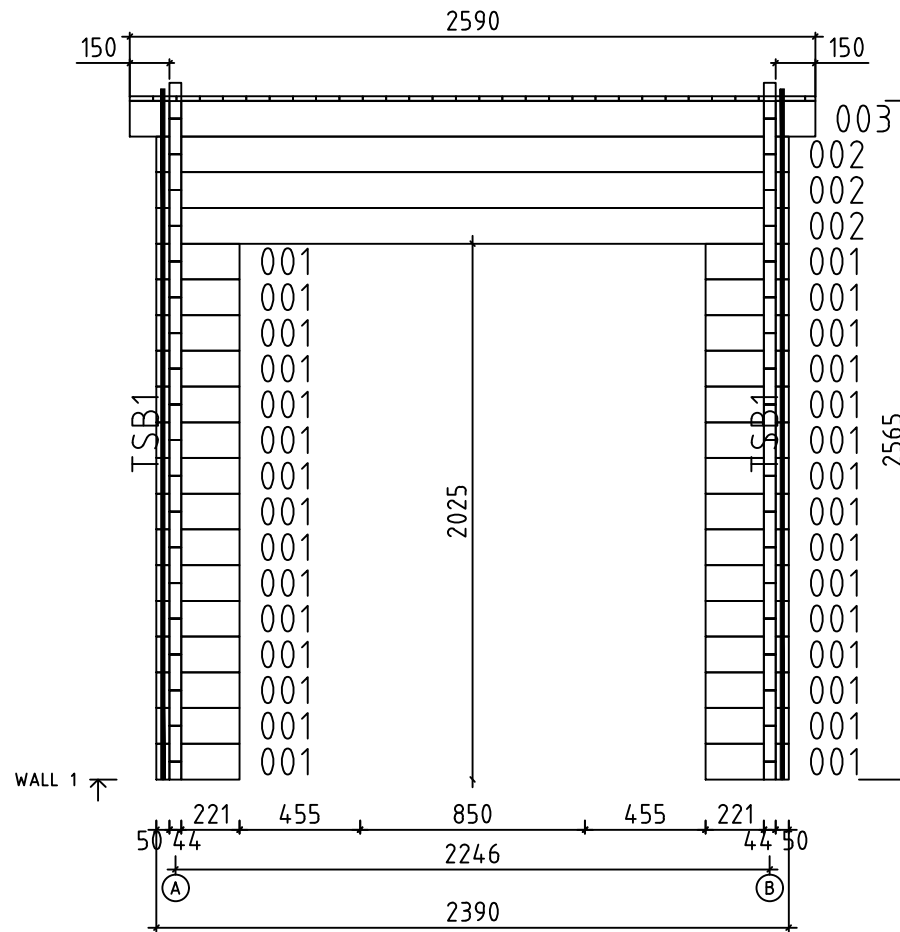
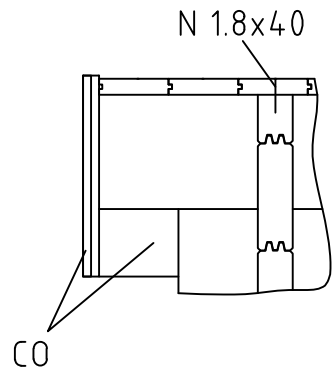

0 0.5m 1.0m 2.0m

Model	Sauna Lupo 44	Drawing	WALL 1	Page	6
		Drawn by	J.S	Material	4.4x13.5
		Date	29.10.2024	File	Sauna Lupo 44.dwg
		Scale	1:20		

