

Alpho**l**Z

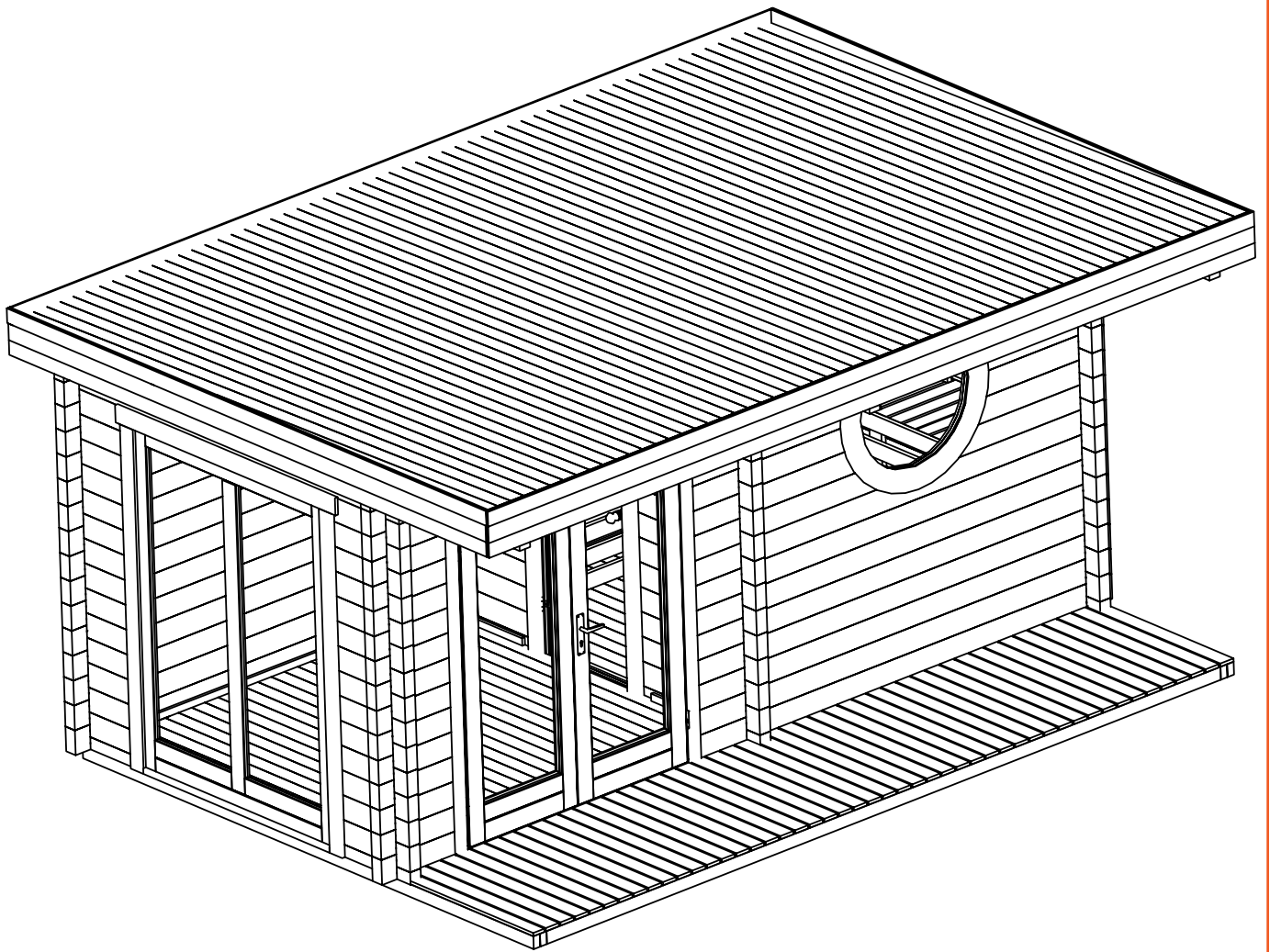

Sauna Enns 70

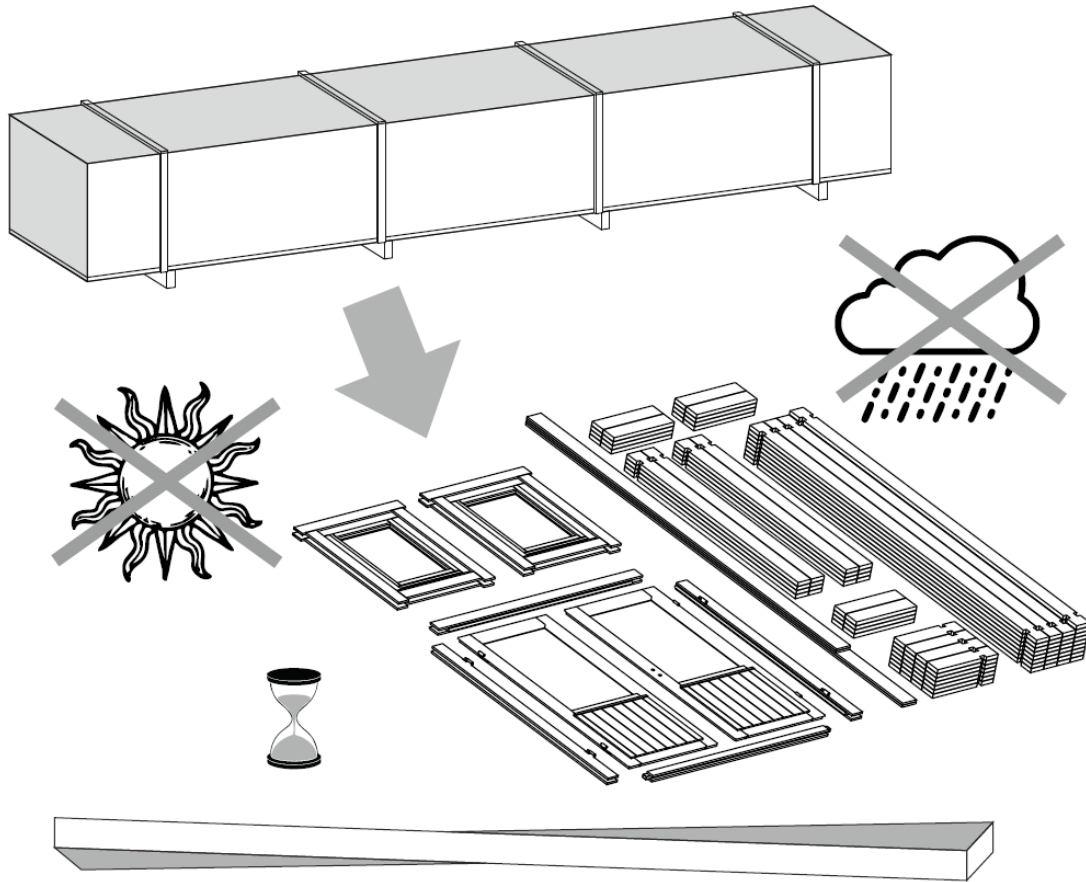

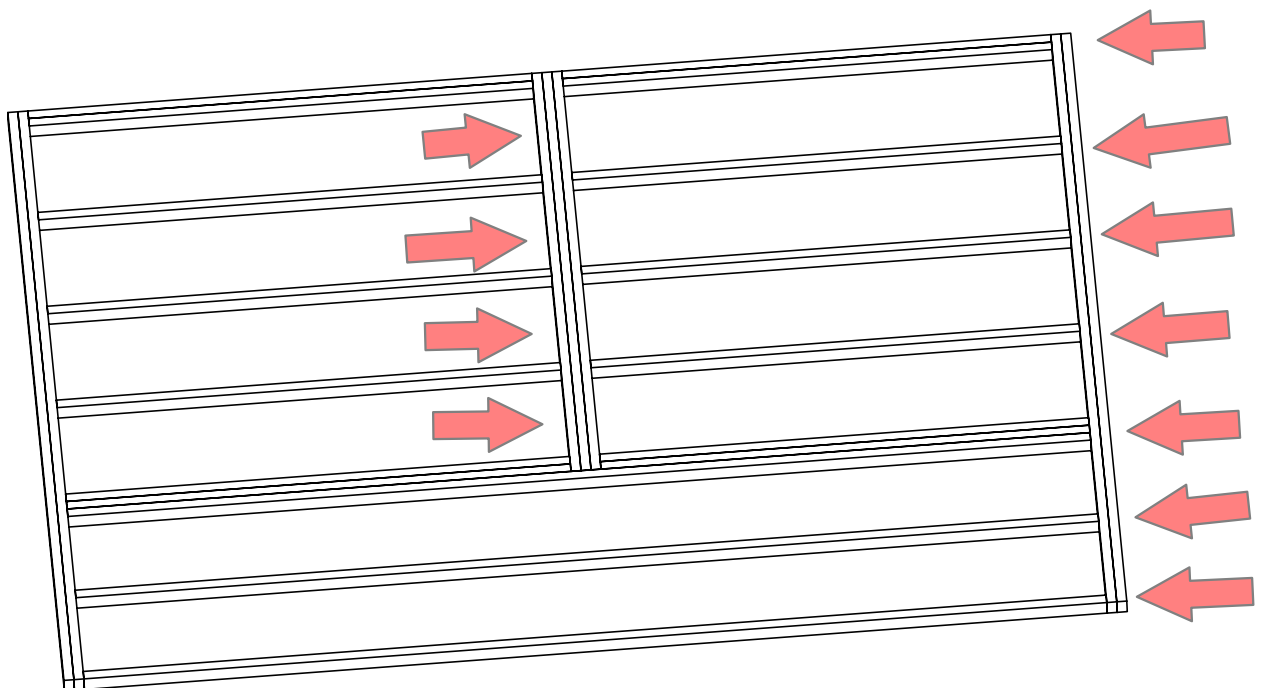
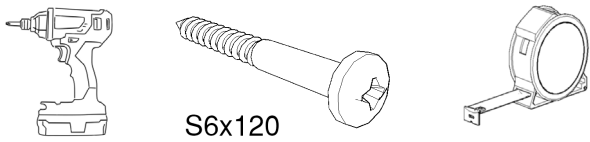
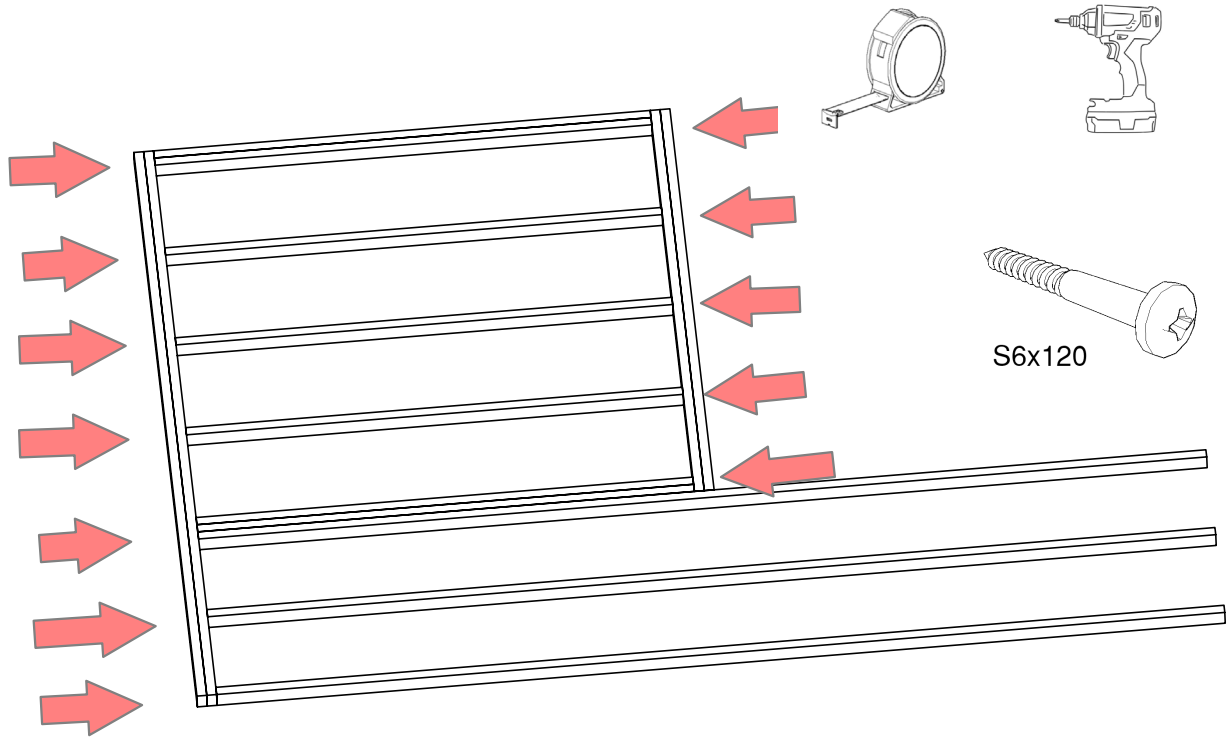

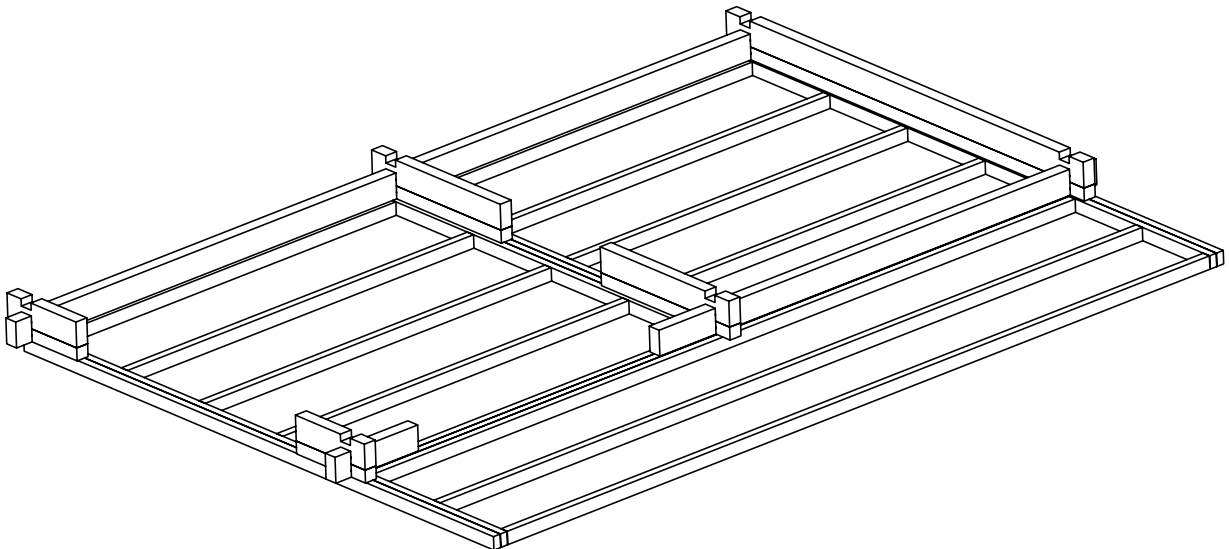
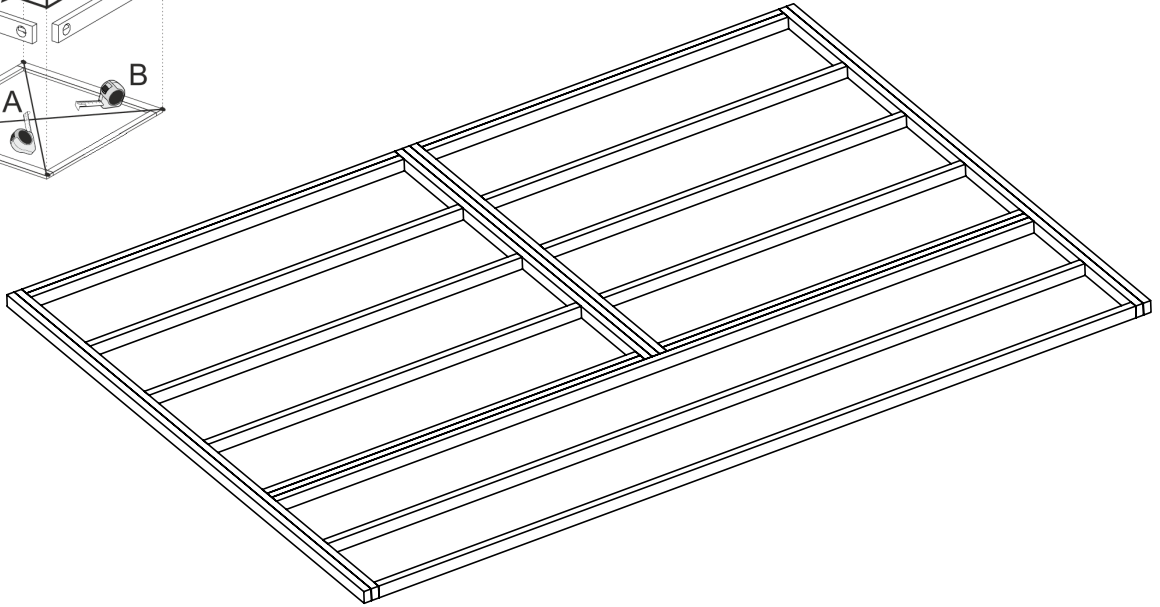
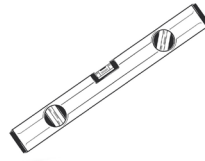
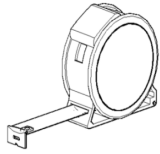
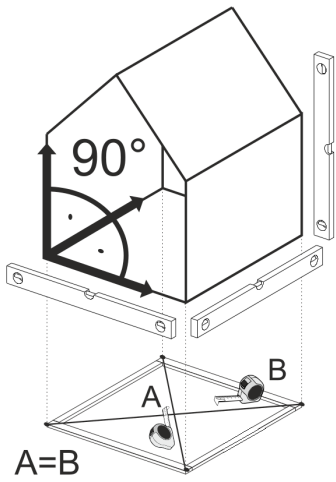

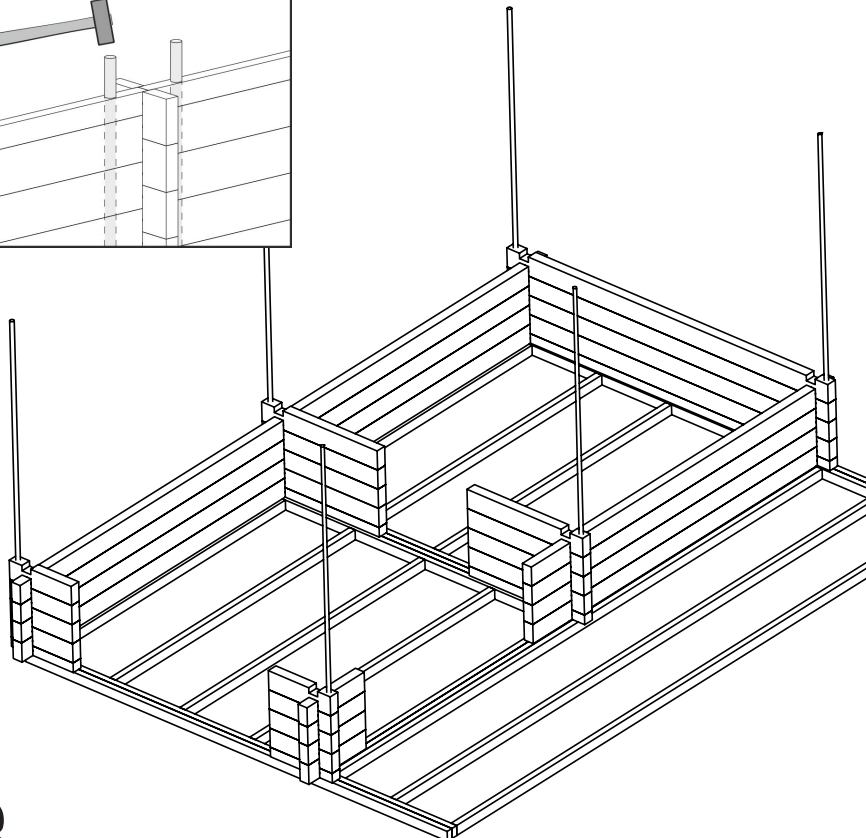
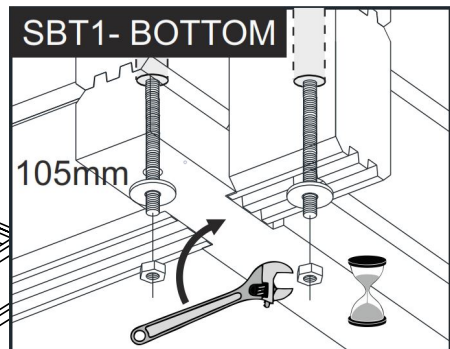
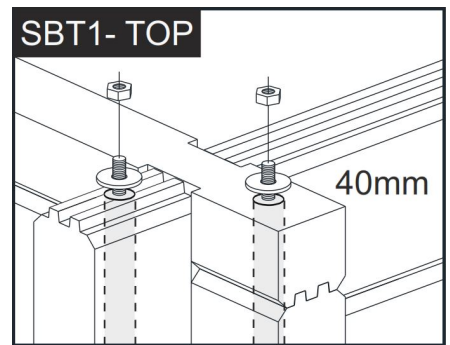
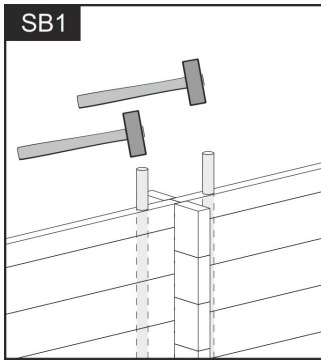
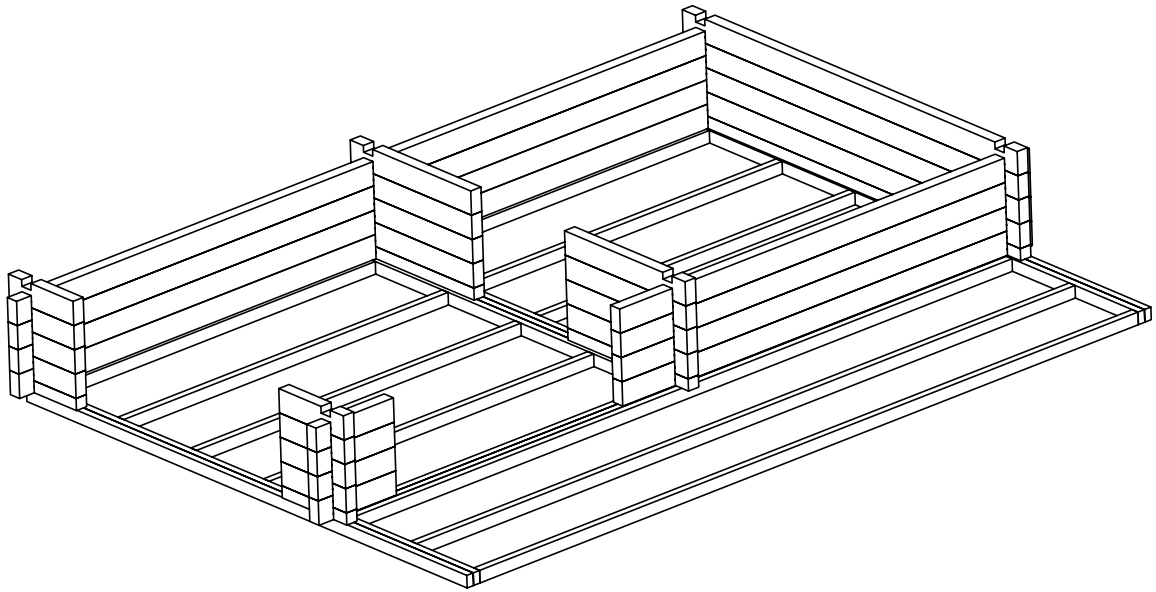

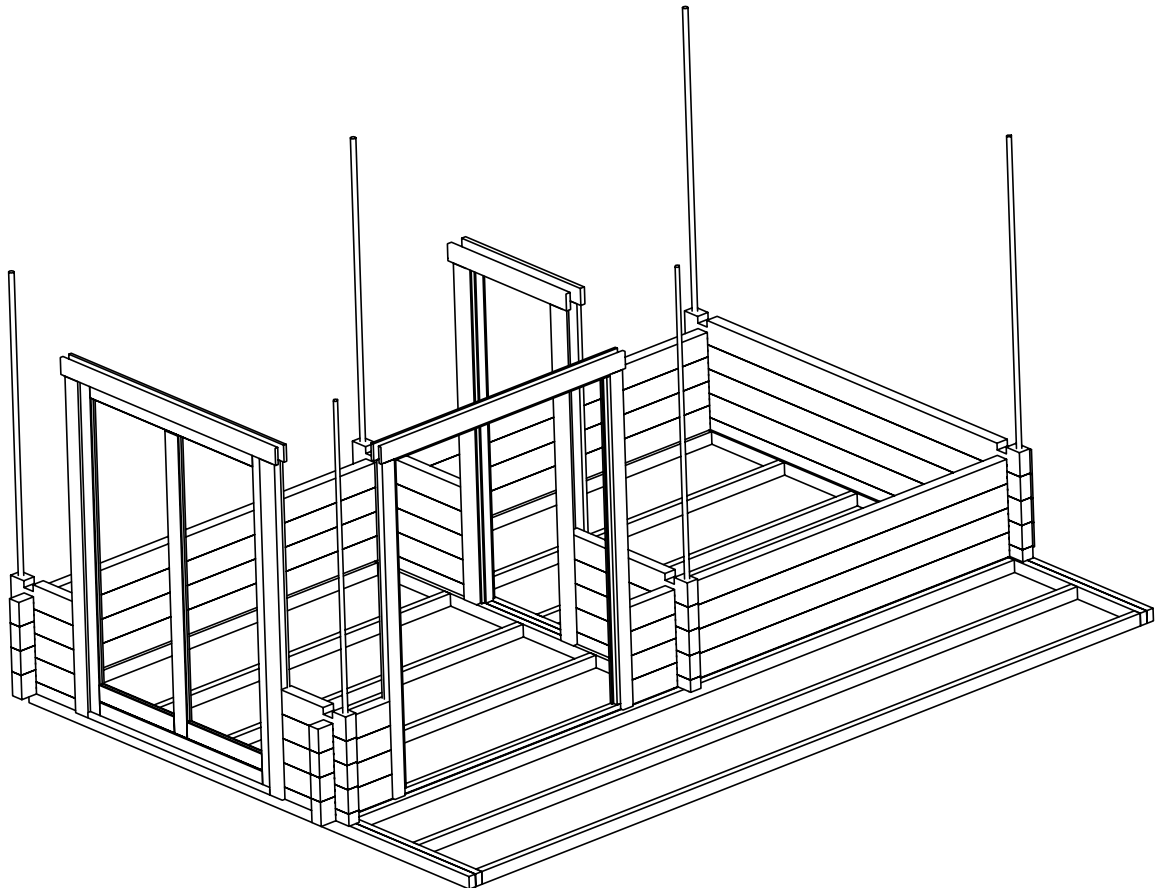
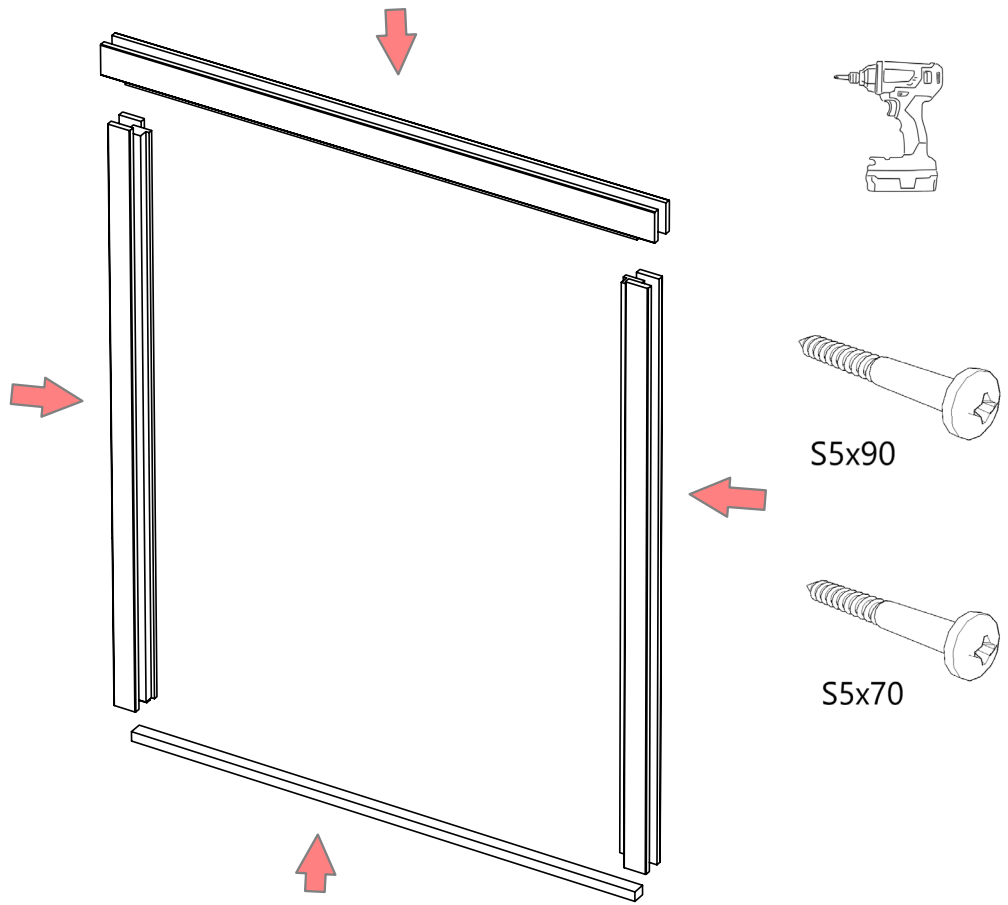

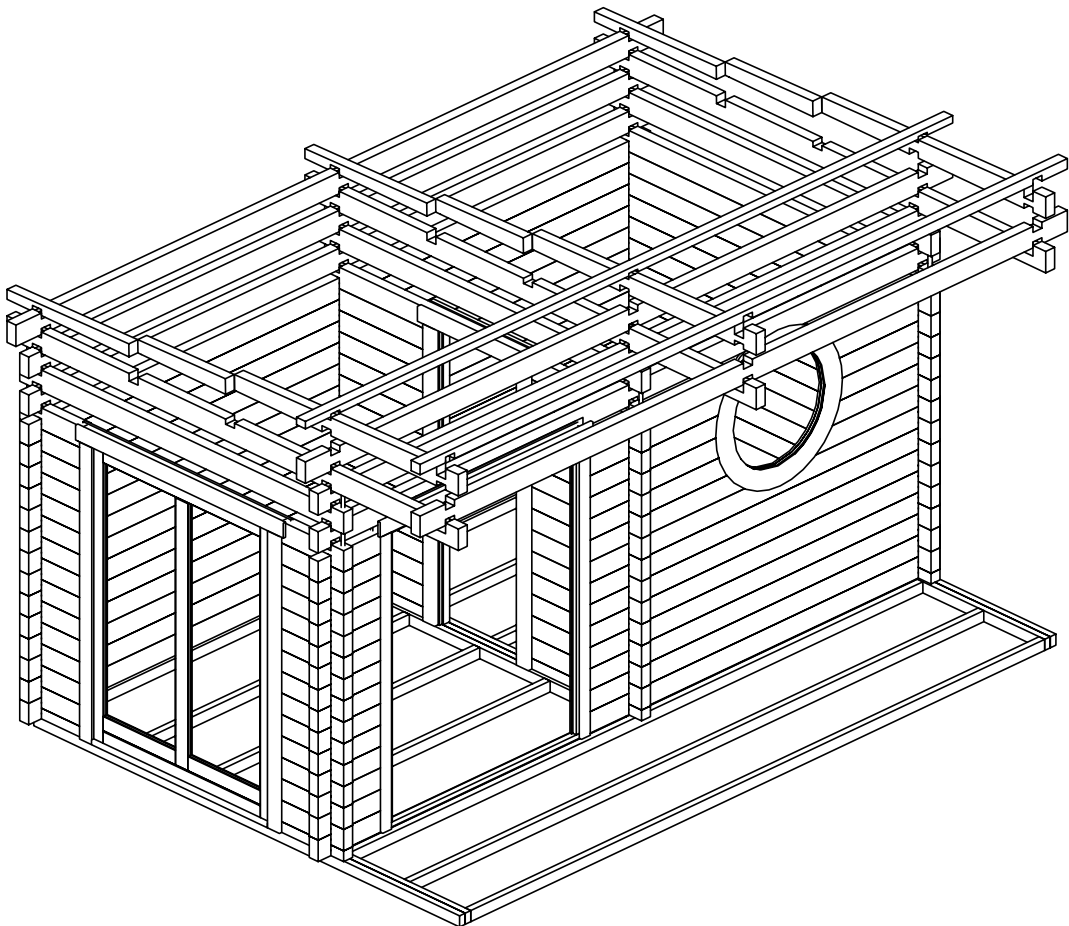
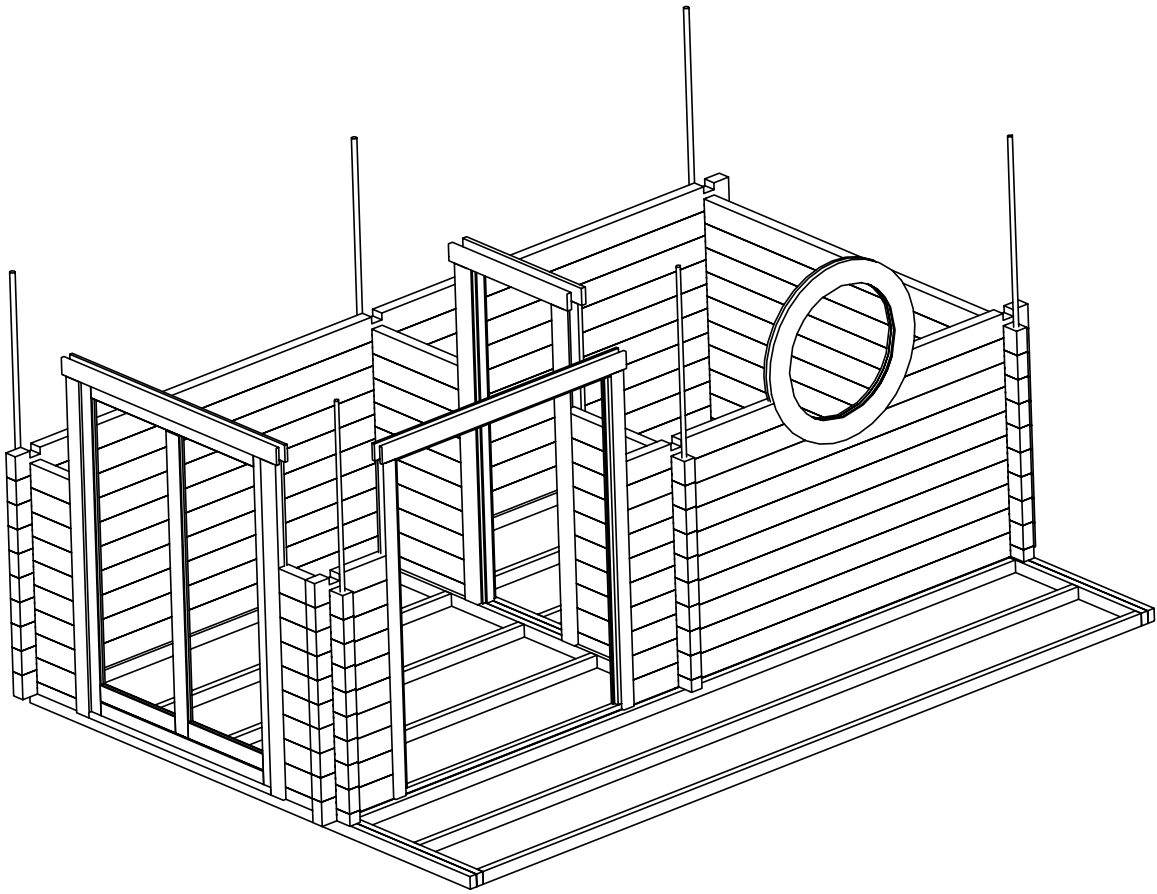

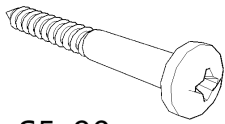
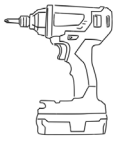

S5x90

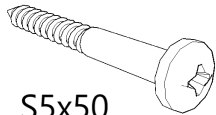
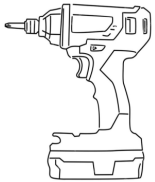
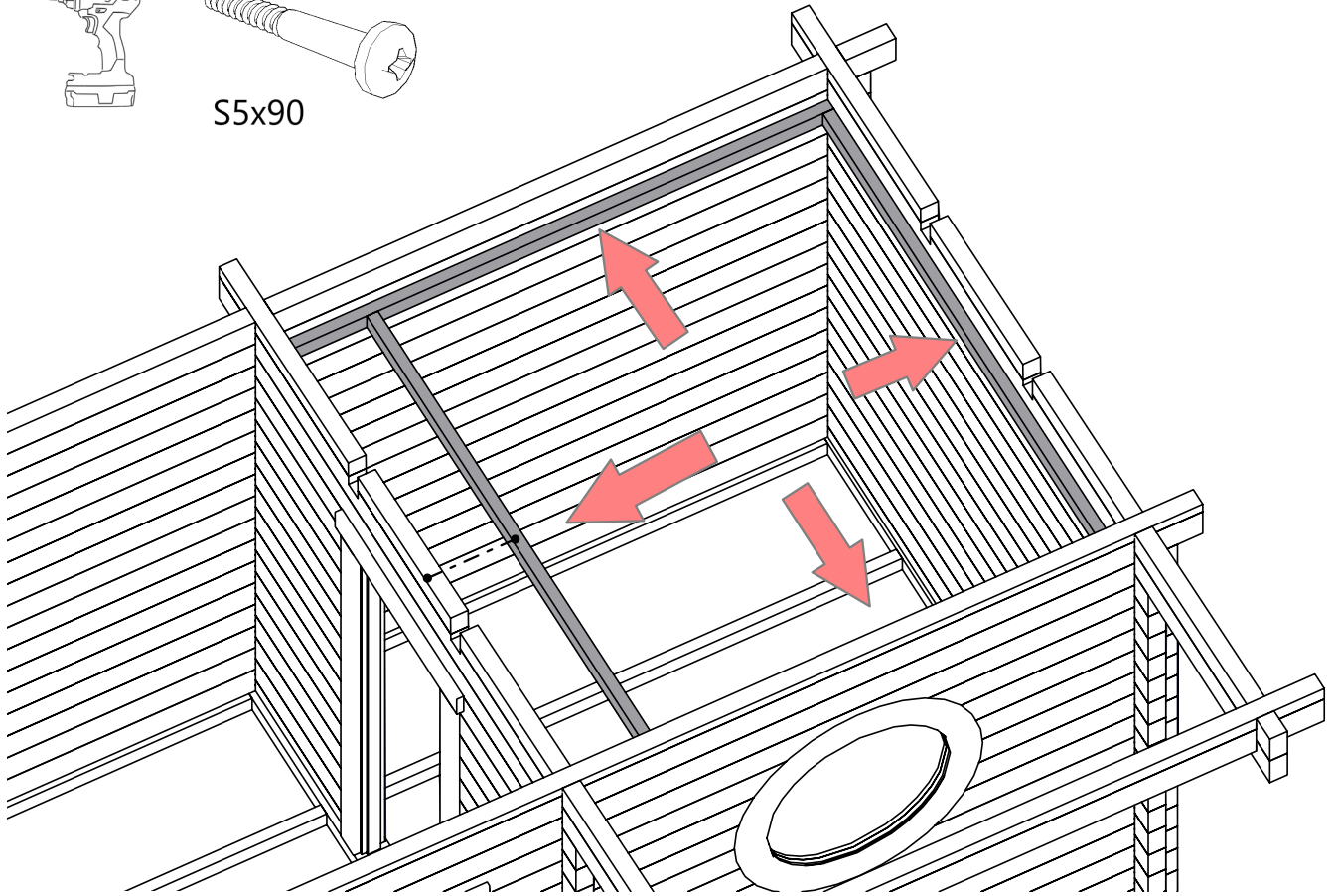

S5x50

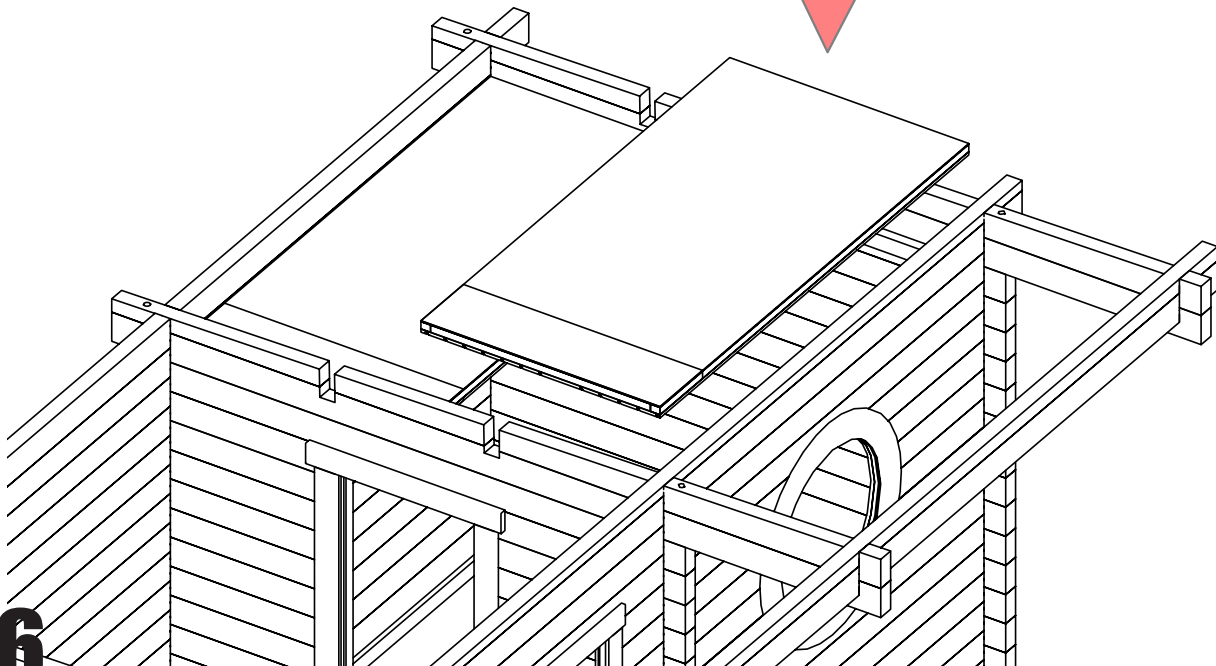

6

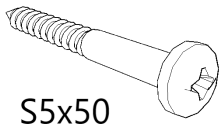
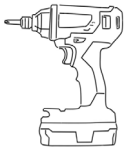

S5x50

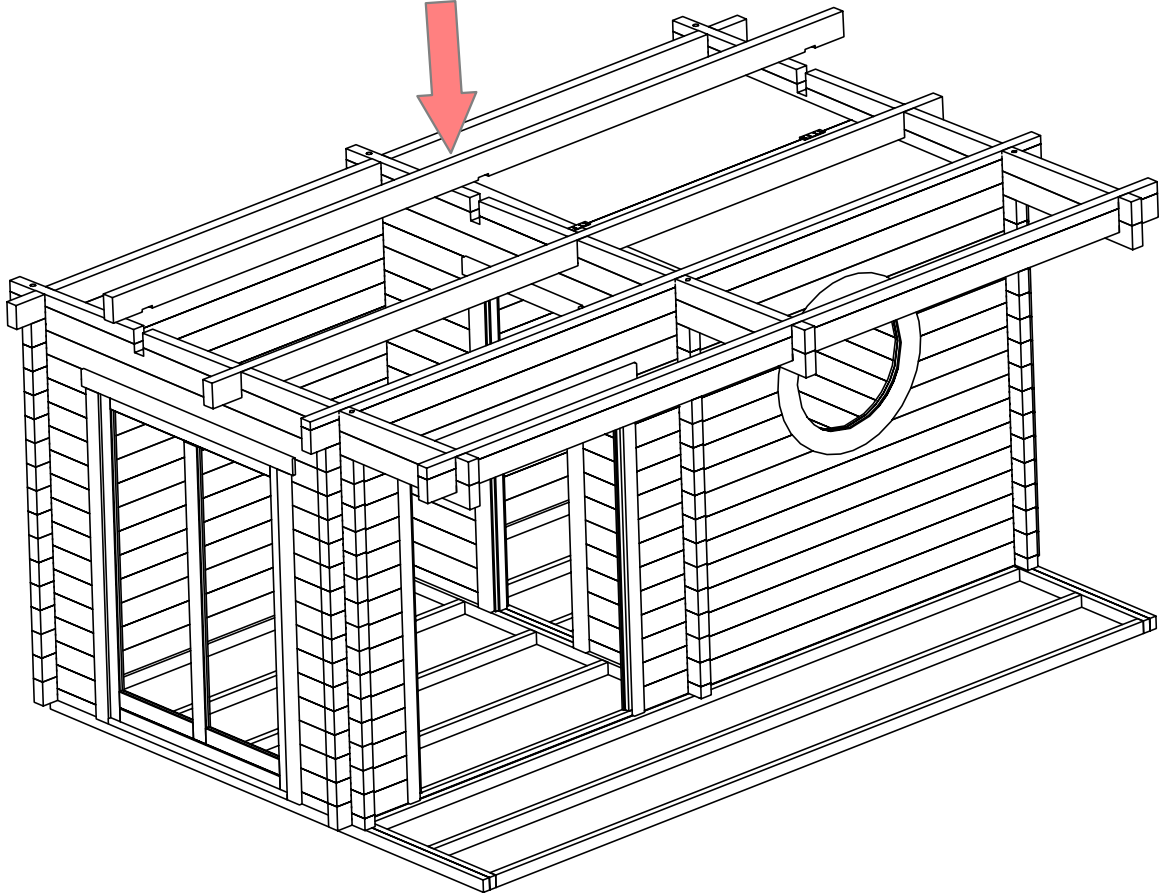
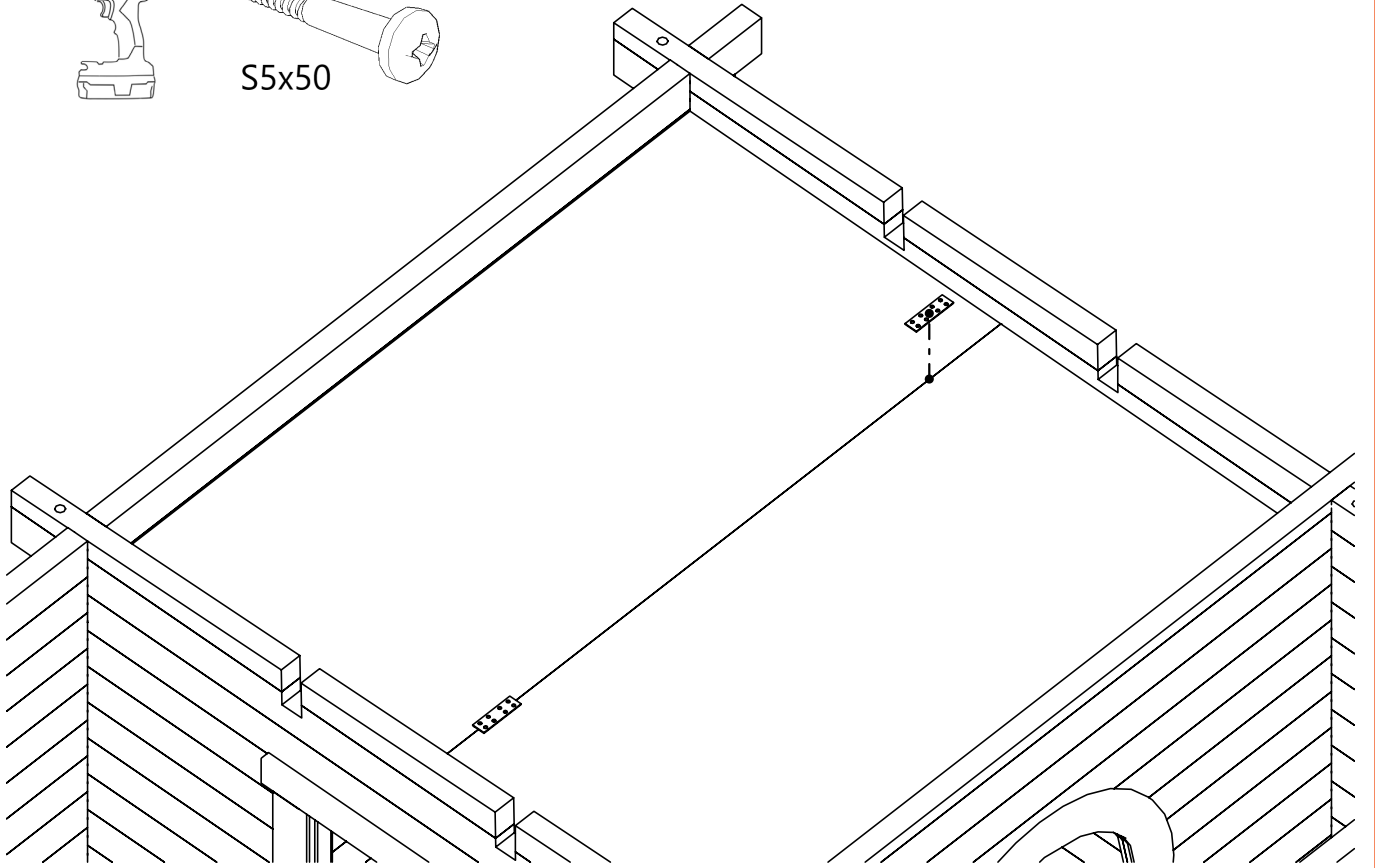

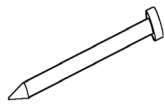

N1,8x40

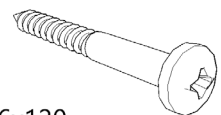
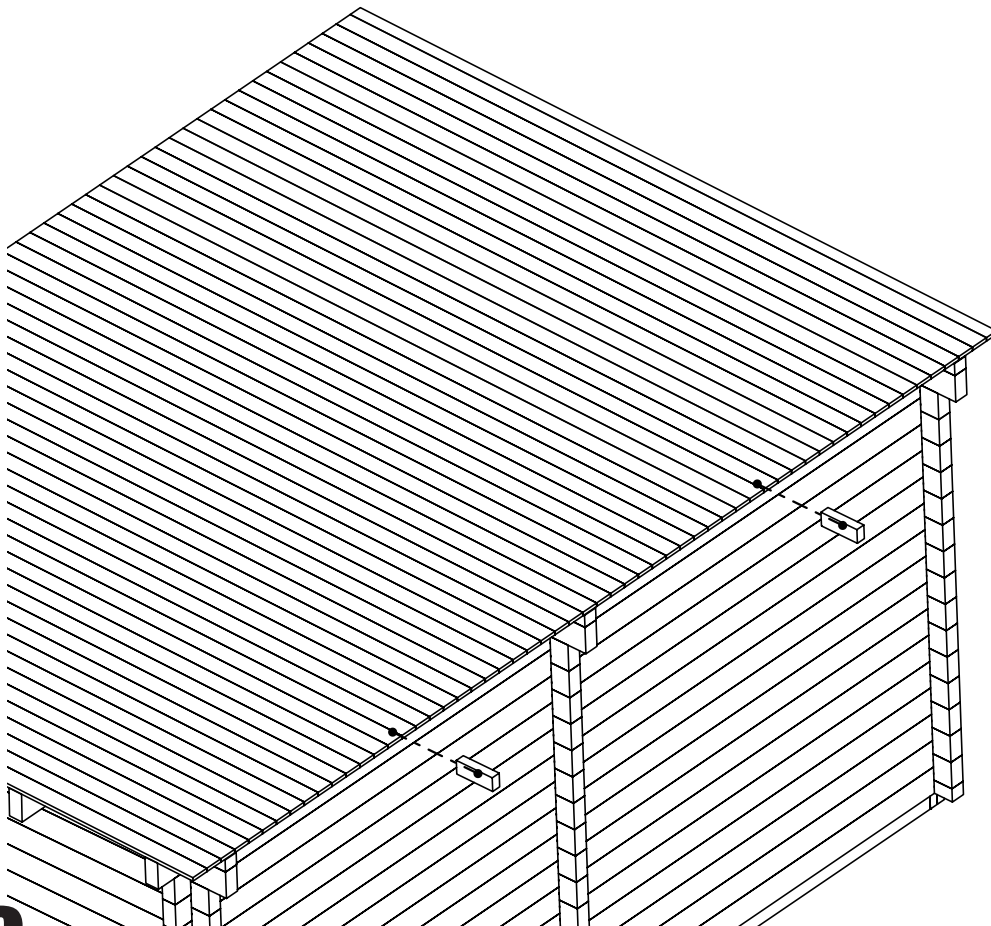
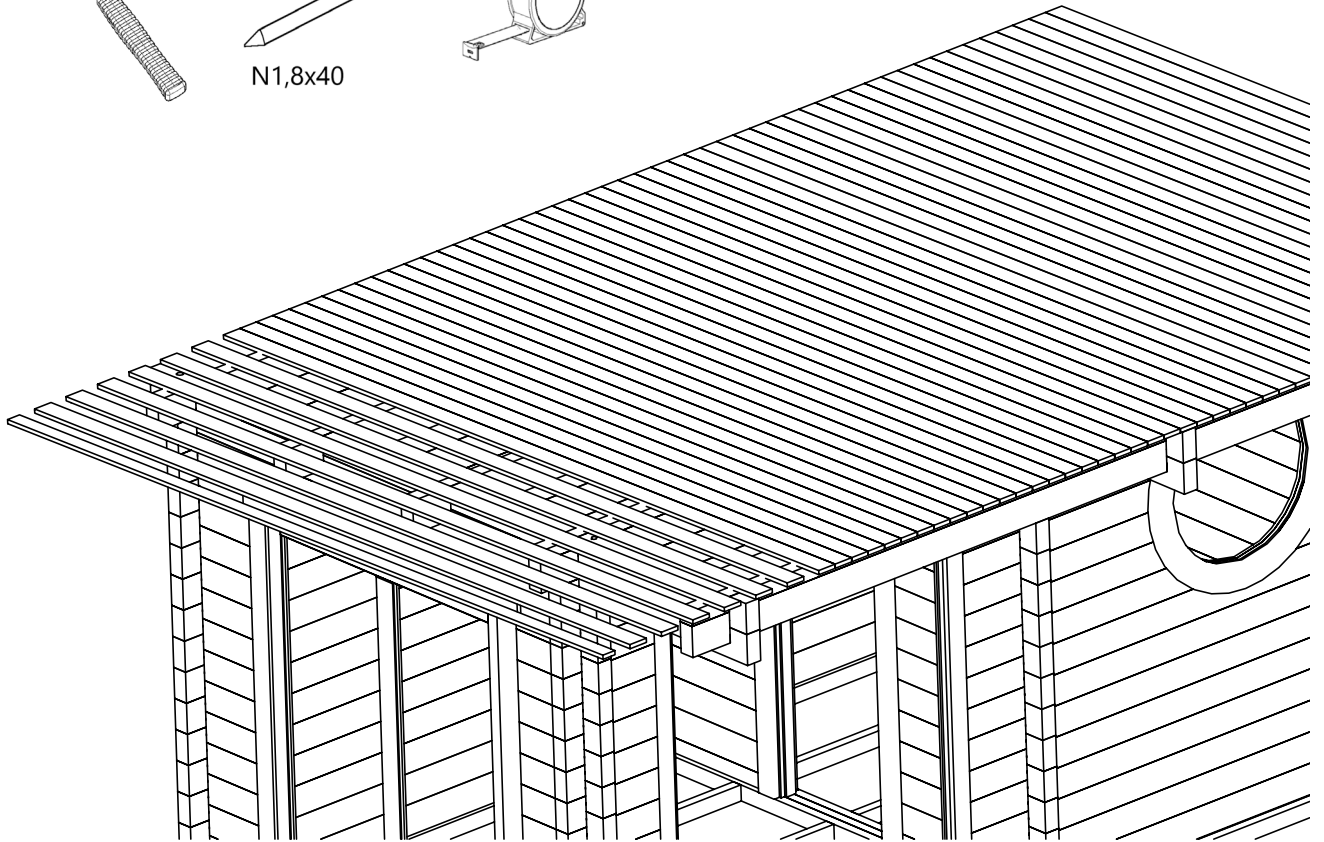
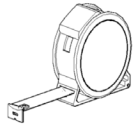

S6x120

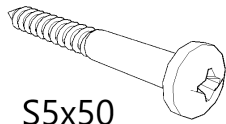
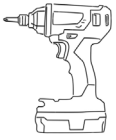

S5x50

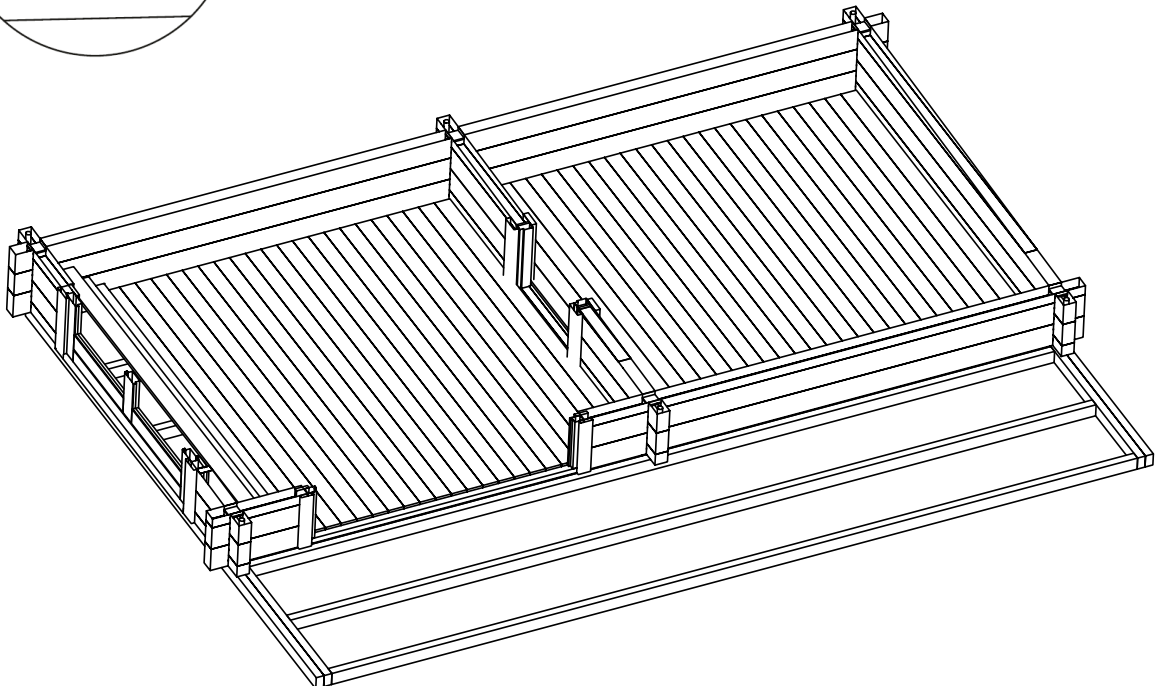
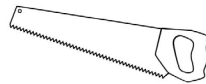
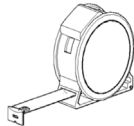
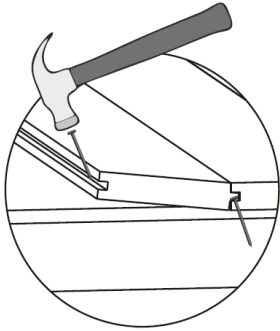
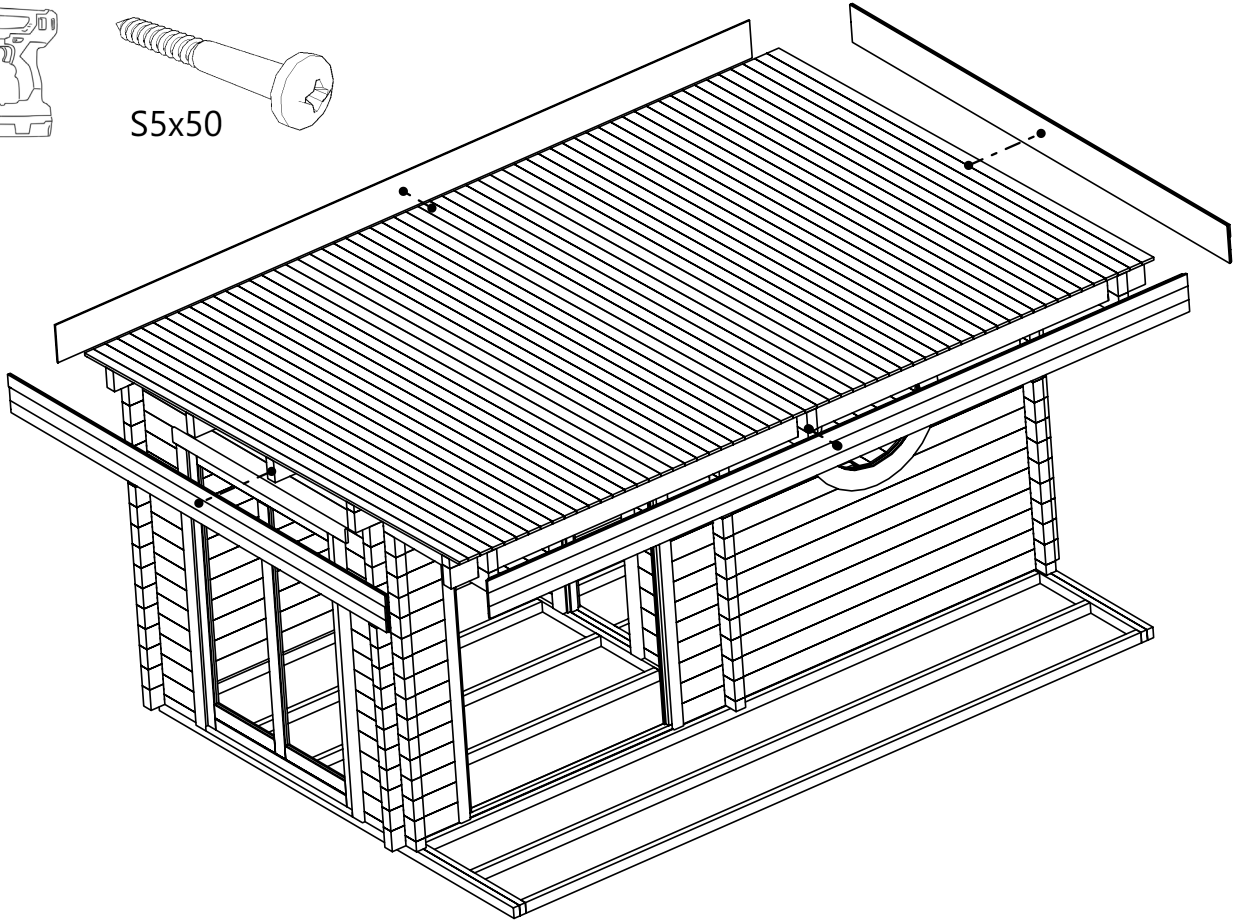

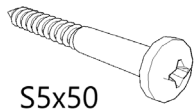
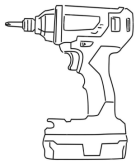

S5x50

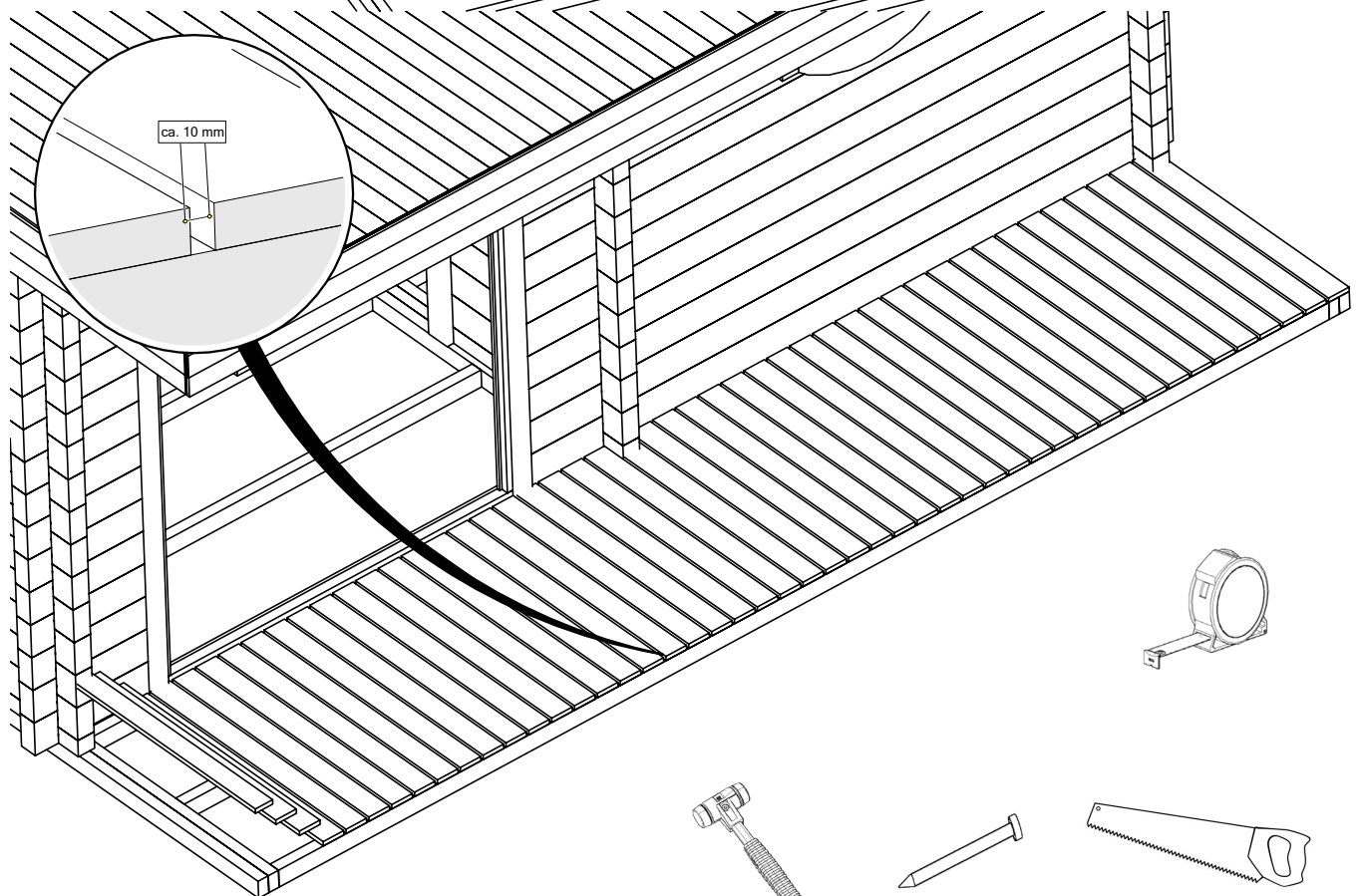
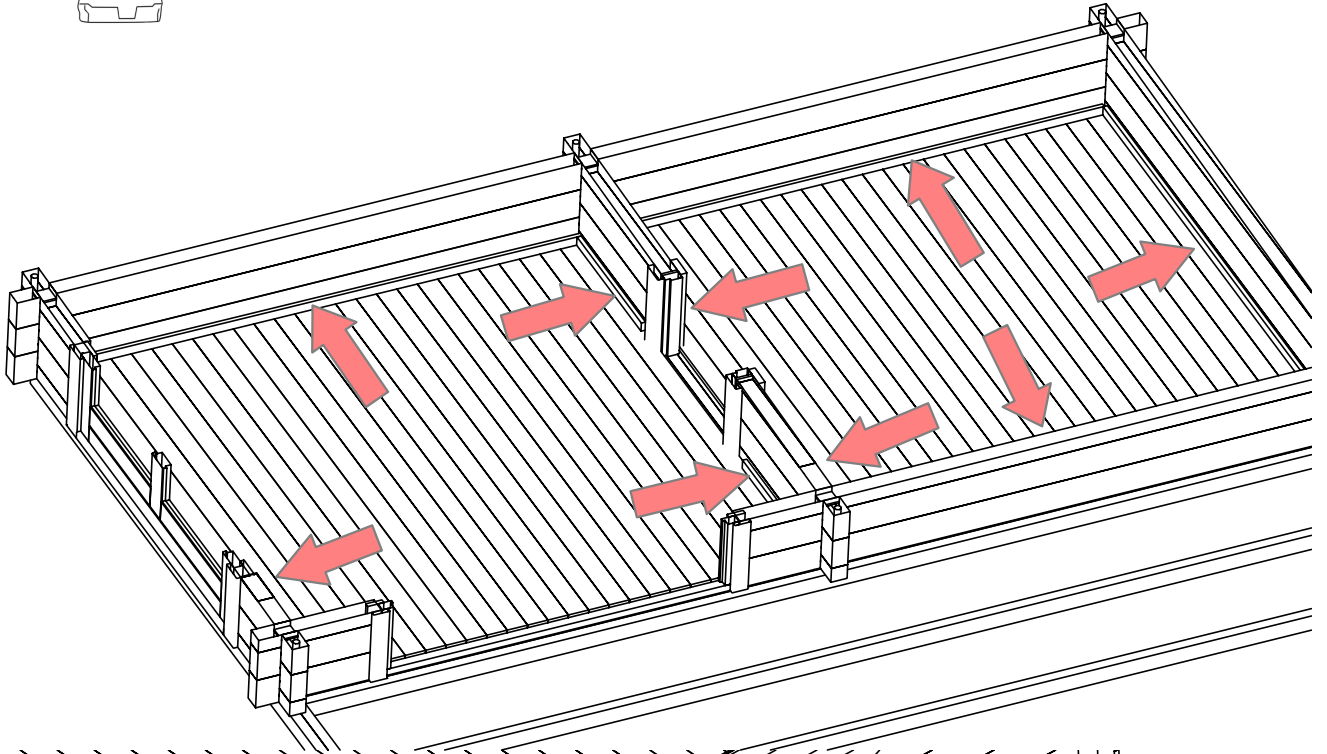
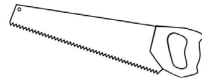
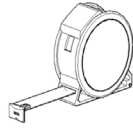

ca. 10 mm

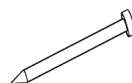
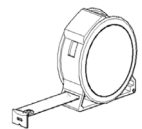

N1,8x40

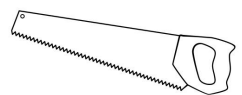

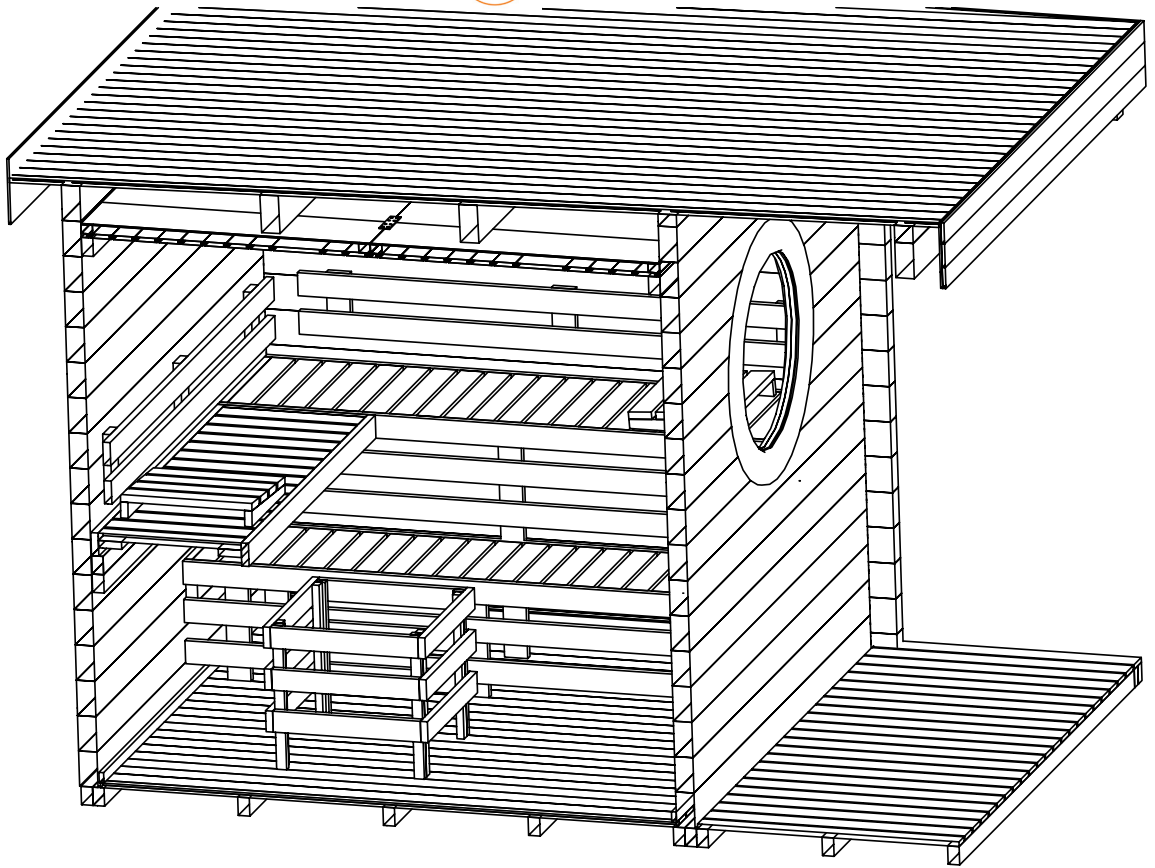

Bitte beachten Sie den Anhang am Ende der Anleitung.
Please refer to the appendix of this section.

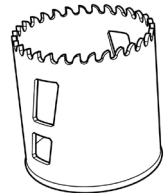
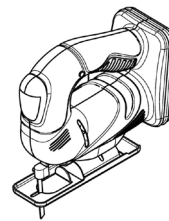
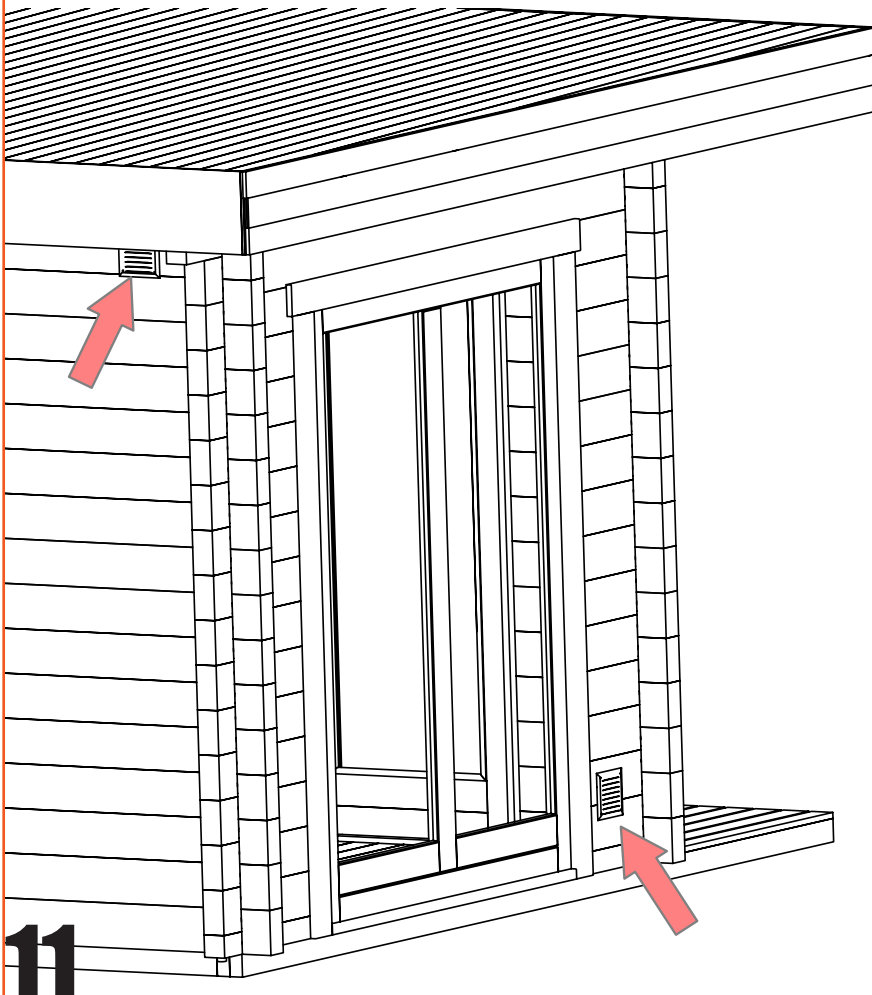

Ø ca 130mm

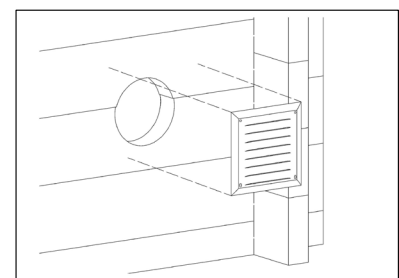
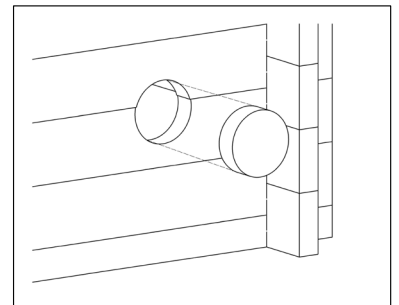

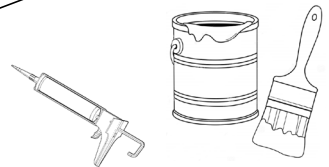
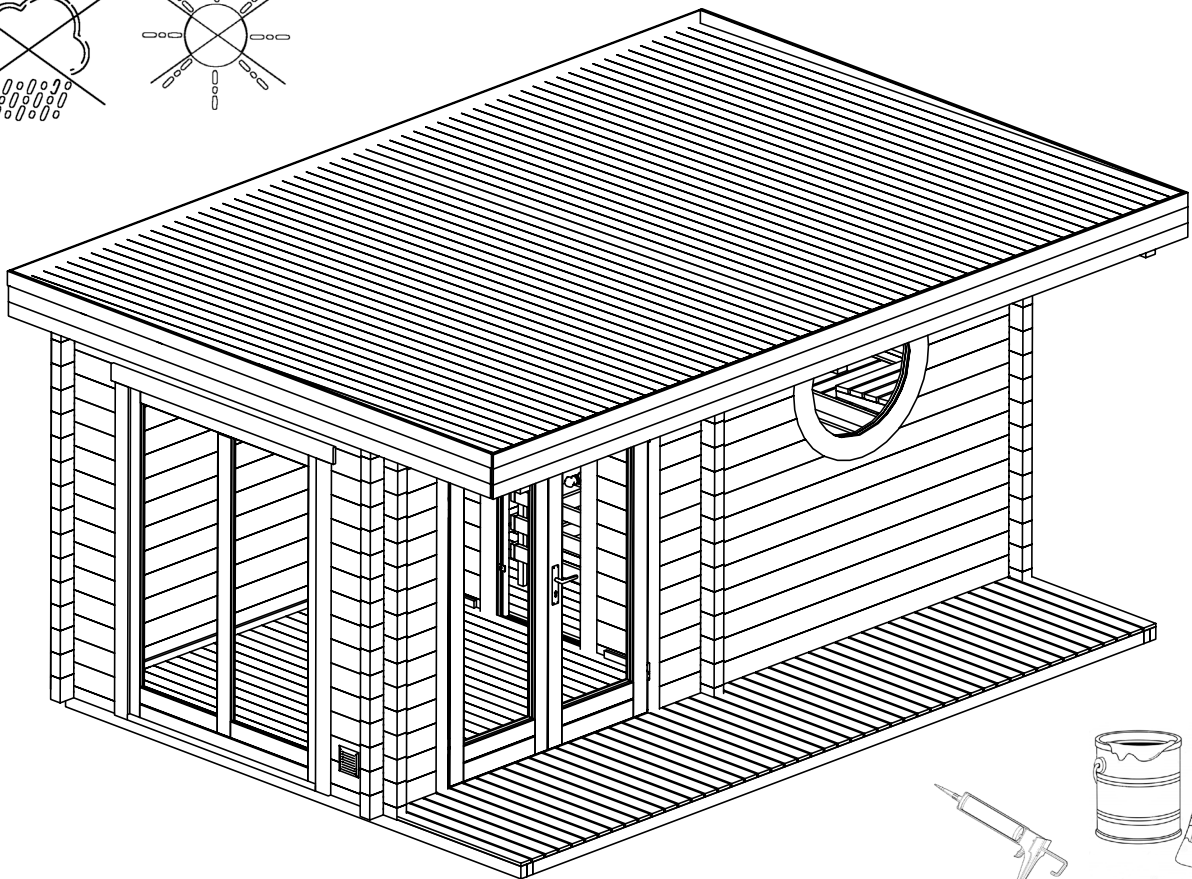
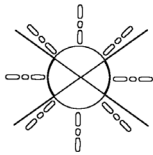
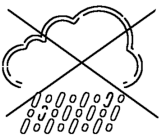
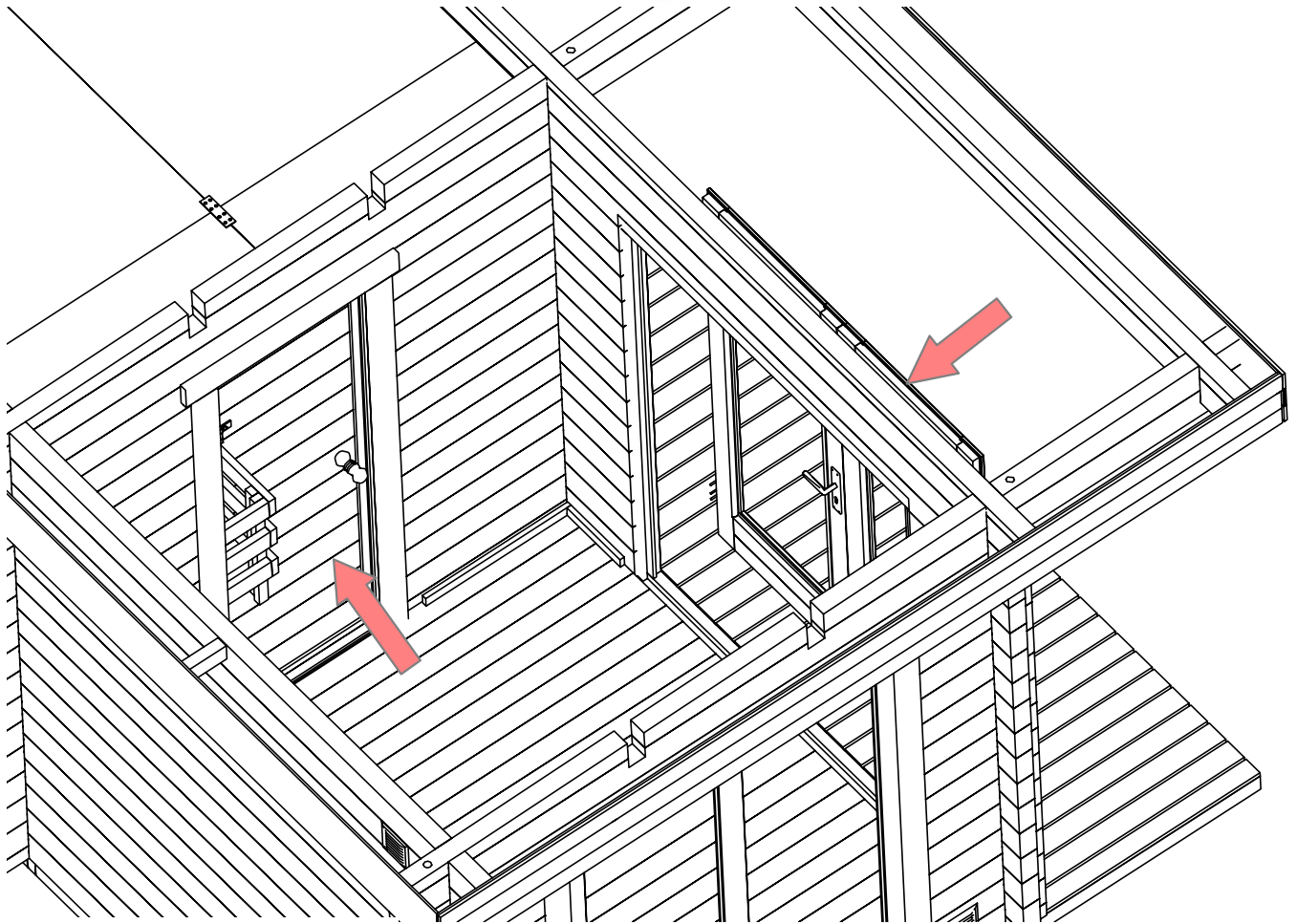

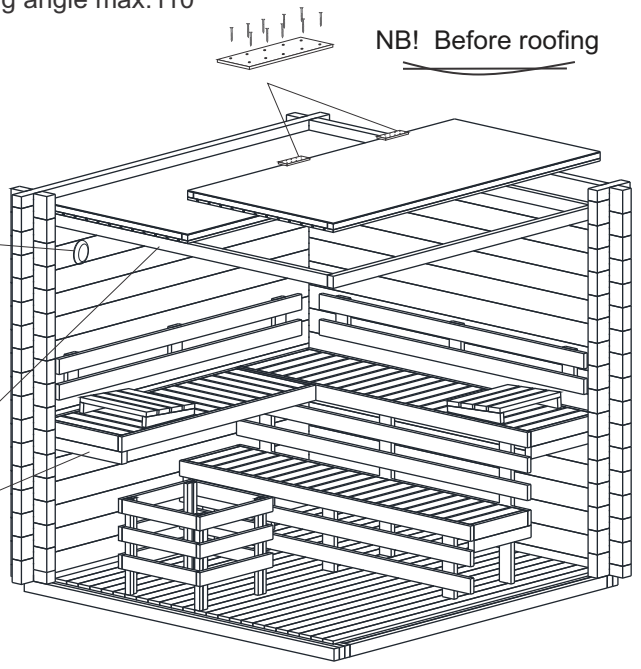
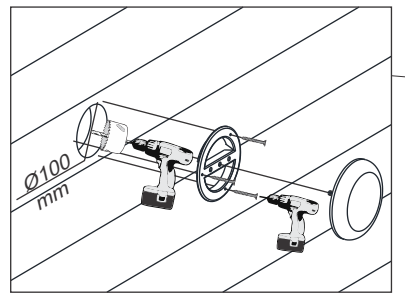
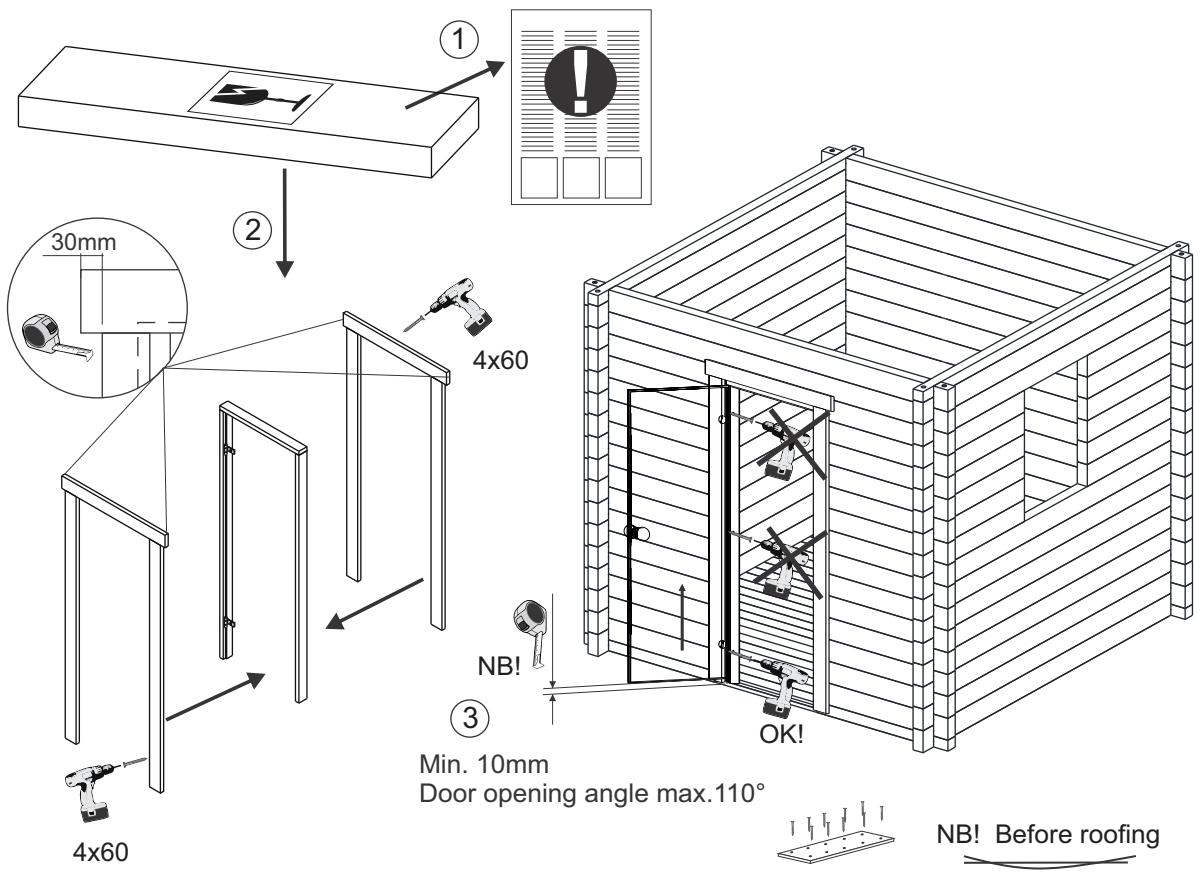

- 58-70mm = 5x90
- 44mm = 5x80
- 40mm = 5x70

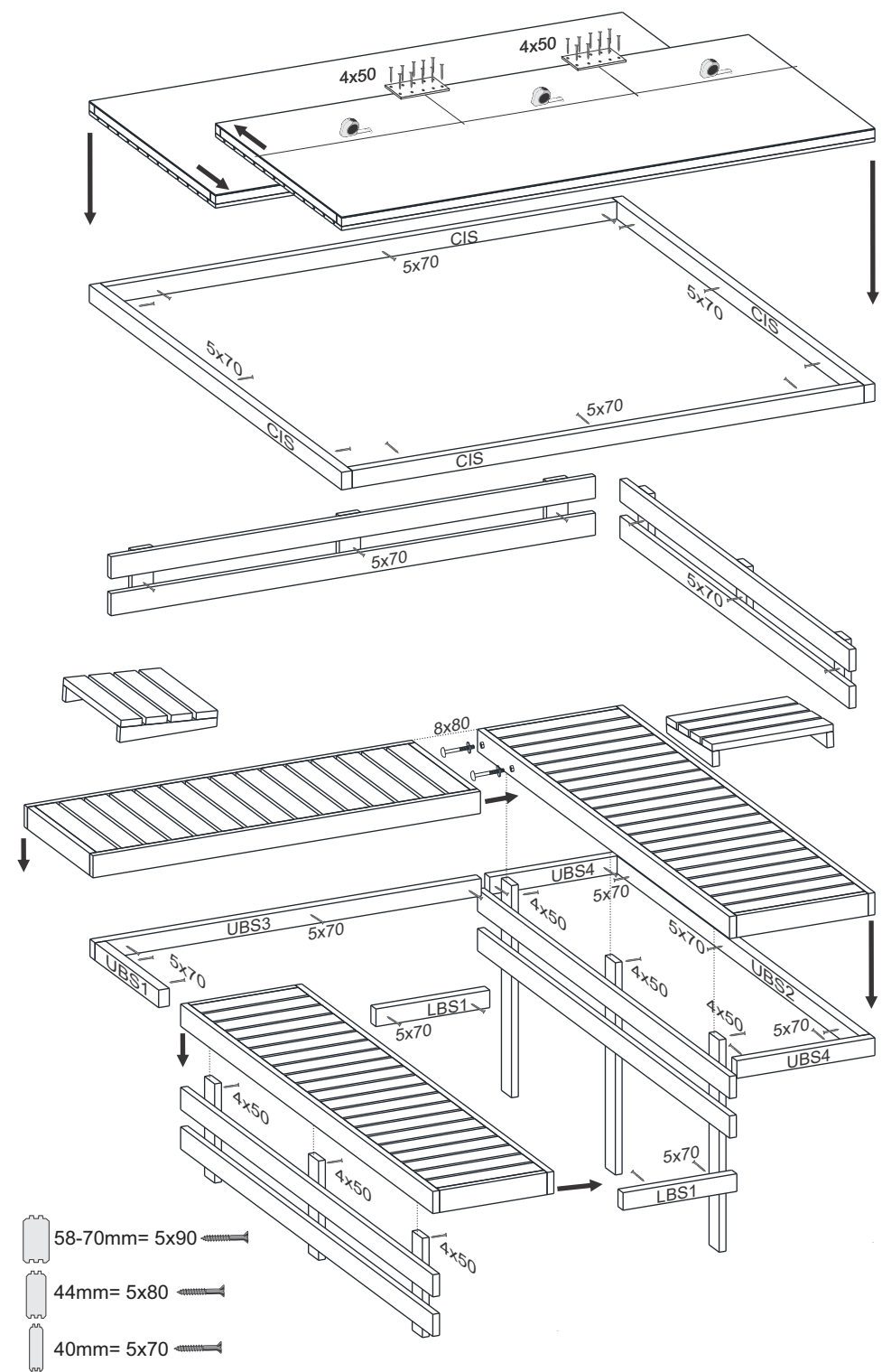

Öffnung/Opening



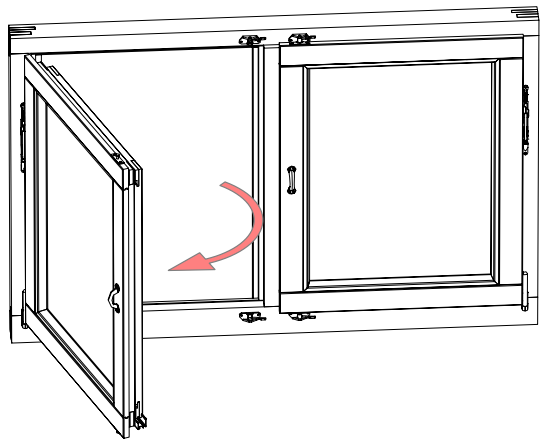
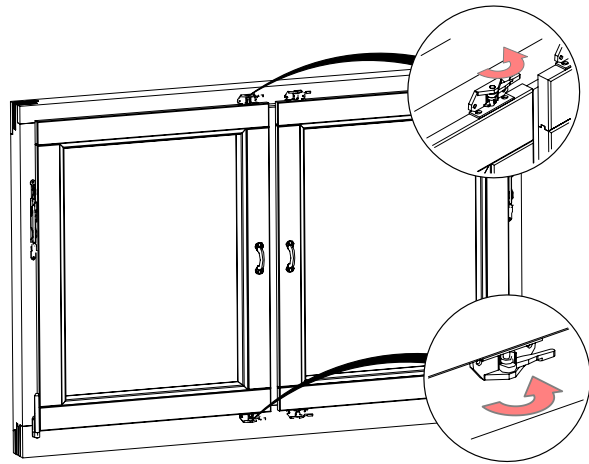

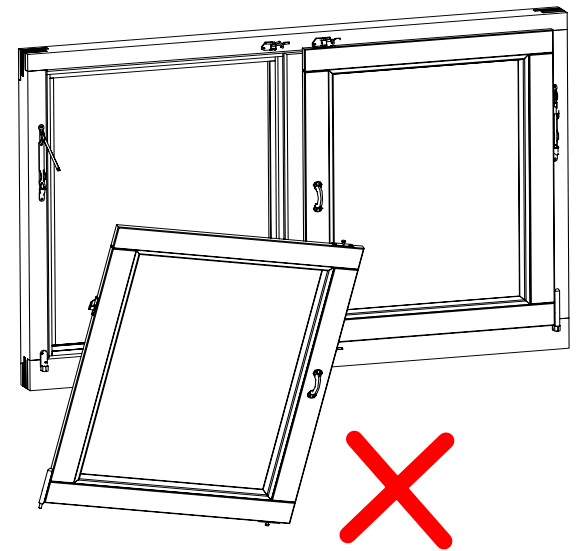
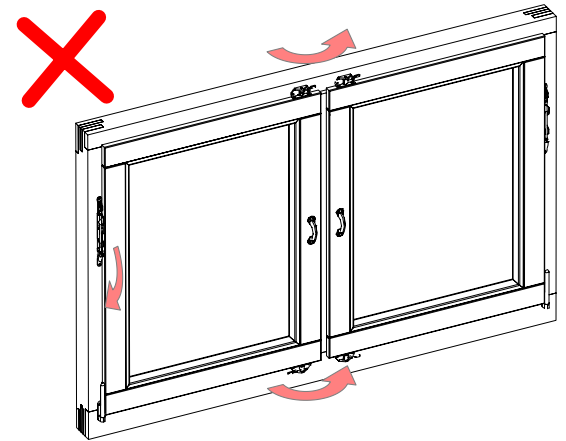
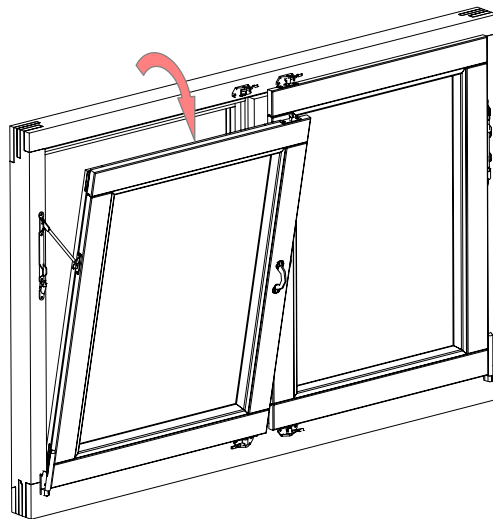
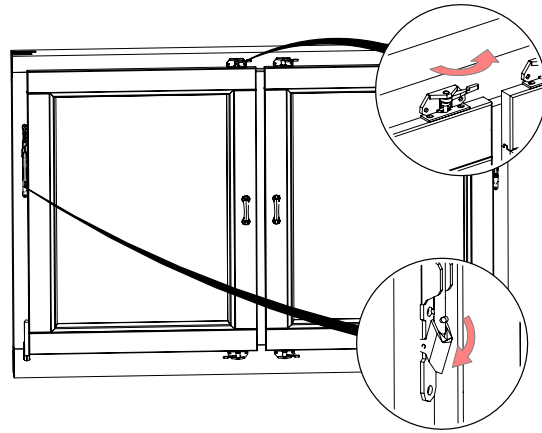

A

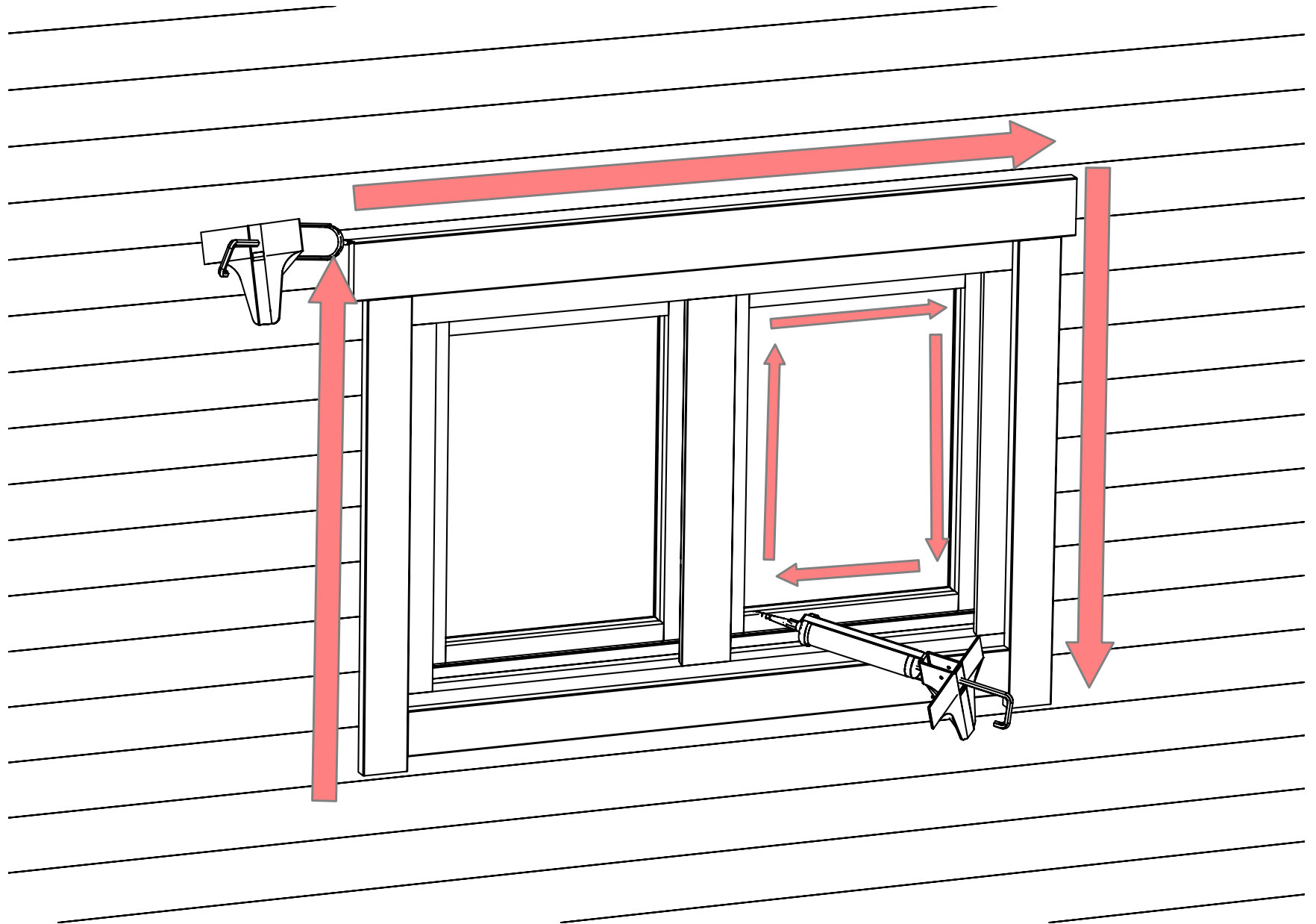
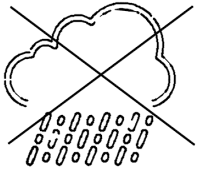

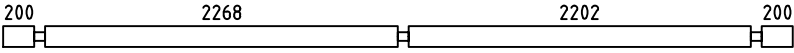
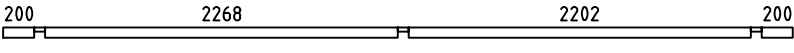

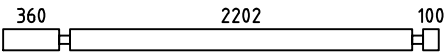
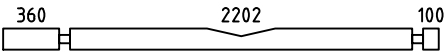
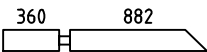
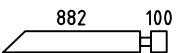
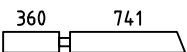
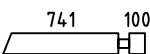
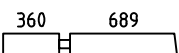
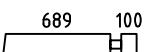
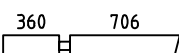
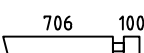
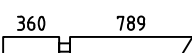
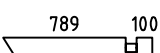
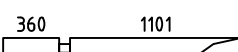
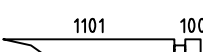
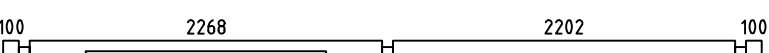
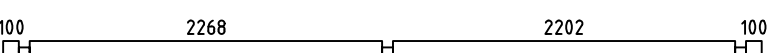

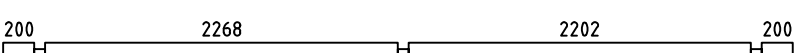



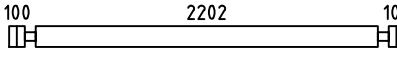
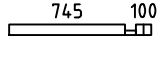
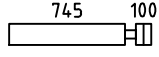
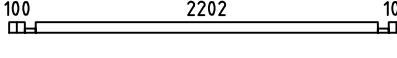
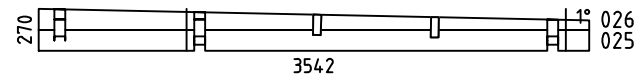
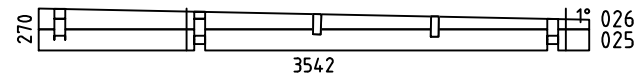
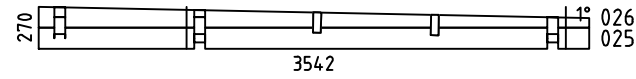
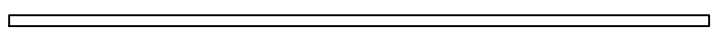
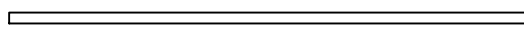
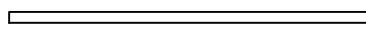
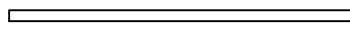
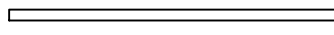

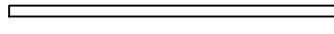
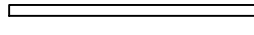



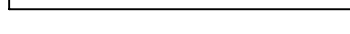
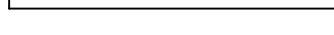
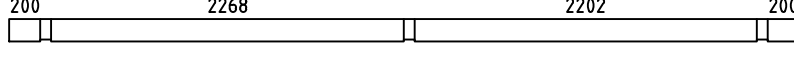
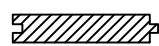







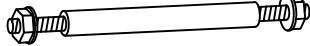

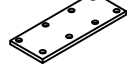
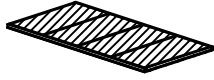

B







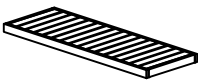
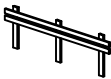
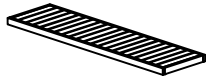

Pos	Specification-Spezifikation-Specificatie-Nomenclature-Elementi-Especificacion Sauna Enns 70	Qty	Profile (mm)	Lenght (mm)
001		2	70x135	5080
002		1	70x65	5080
003		14	70x135	530
004		7	70x135	2802
005		1	70x135	2802
006		1	70x135	1312
007		1	70x135	1052
008		1	70x135	1171
009		1	70x135	911
010		1	70x135	1119
011		1	70x135	859
012		1	70x135	1136
013		1	70x135	876
014		1	70x135	1219
015		1	70x135	959
016		1	70x135	1531
017		1	70x135	1271
018		1	70x135	4880
019		17	70x135	4880
020		1	70x47	5080
021		1	70x135	5080
022		2	70x68	490
023		28	70x135	490
Kood	Sauna Enns 70	Materjal	File Sauna Enns 70.dwg	Leht 1/4

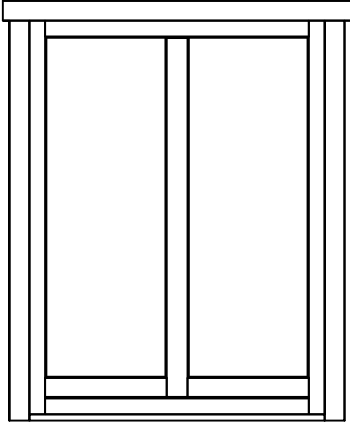
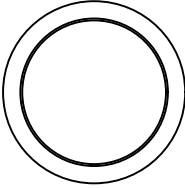
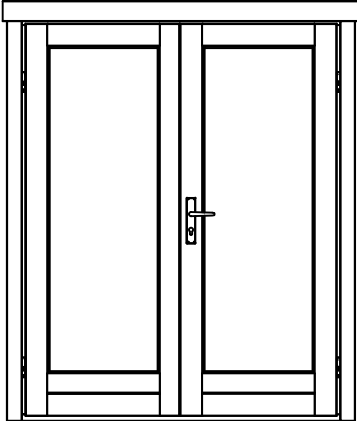
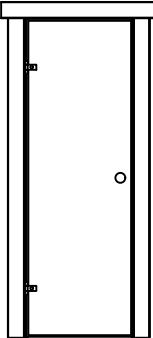
Pos	Specification-Spezifikation-Specificatie-Nomenclature-Elementi-Especificacion Sauna Enns 70	Qty	Profile (mm)	Lenght (mm)		
024		17	70x135	2542		
027		2	70x68	915		
028		28	70x135	915		
029		1	70x68	2542		
EXTRA		1	70x135	4880		
WA-1		1				
WB-1		1				
WC-1		1				
F5	FOUNDATION-FUNDAMENT-FONDATION-FONDAZIONE-VIGAS DE CIMENTACIÓN 	3	44x70	4504		
F1	FOUNDATION-FUNDAMENT-FONDATION-FONDAZIONE-VIGAS DE CIMENTACIÓN 	4	44x70	3342		
F2	FOUNDATION-FUNDAMENT-FONDATION-FONDAZIONE-VIGAS DE CIMENTACIÓN 	3	44x70	2342		
F3	FOUNDATION-FUNDAMENT-FONDATION-FONDAZIONE-VIGAS DE CIMENTACIÓN 	7	44x70	2219		
F4	FOUNDATION-FUNDAMENT-FONDATION-FONDAZIONE-VIGAS DE CIMENTACIÓN 	7	44x70	2153		
CS1	CORNICE SUPPORT-TRAGELEISTE-STEUNEN BAR-SUPPORT-SUPPORTO-SOPORTE 	2	44x70	200		
UBS2	UPPER BENCH SUPPORT-TRAGELEISTE-STEUNEN BAR-SUPPORT-SUPPORTO-SOPORTE 	1	44x70	2112		
UBS3	UPPER BENCH SUPPORT-TRAGELEISTE-STEUNEN BAR-SUPPORT-SUPPORTO-SOPORTE 	1	44x70	1595		
UBS4	UPPER BENCH SUPPORT-TRAGELEISTE-STEUNEN BAR-SUPPORT-SUPPORTO-SOPORTE 	2	44x70	570		
UBS1	UPPER BENCH SUPPORT-TRAGELEISTE-STEUNEN BAR-SUPPORT-SUPPORTO-SOPORTE 	1	44x70	555		
LBS1	LOWER BENCH SUPPORT-TRAGELEISTE-STEUNEN BAR-SUPPORT-SUPPORTO-SOPORTE 	2	44x70	470		
CIS2	CEILING INSULATION SUPPORT-TRAGELEISTE-STEUNEN BAR-SUPPORT-SUPPORTO-SOPORTE 	2	44x70	2202		
CIS1	CEILING INSULATION SUPPORT-TRAGELEISTE-STEUNEN BAR-SUPPORT-SUPPORTO-SOPORTE 	2	44x70	2112		
PL1	PURLIN-DAKBALK-DACHPFETTE-PANNE-ARCARECCIO-CORREA 	2	70x144	5080		
F-1	Floor board-Fussbodenbrett-Vloerplank-Lame de plancher-Tavola pavimento-Tabla de suelo 	51 40	88x18 114x18	2192		
Kood	Sauna Enns 70	Materjal	File	Sauna Enns 70.dwg	Leht	2/4

Pos	Specification-Spezifikation-Specificatie-Nomenclature-Elementi-Especificacion Sauna Enns 70	Qty	Profile (mm)	Lenght (mm)		
R-1	Roof board-Dachbrett-Dakplank-Volige-Tavola tetto-Tabla de tejado 	58+1	88x18	3540		
		45+1	114x18			
T-1	Terrace board-Terrassendiele-Vlonderplank-Lame de terrasse-Tavola terrazzo-Tabla de terraza 	48	88x18	995		
CO-1	Cornice 20x250-Gesimse-Kroonlijst-Corniche-Cornicione-Cornisa 	2	20x250	3556		
CO-2	Cornice 20x250-Gesimse-Kroonlijst-Corniche-Cornicione-Cornisa 	2	20x250	5120		
FLB-1	Floor beading 3000-Fussbodenleiste-Plinten-Moulure de finition-Listello pavimento-Liston de suelo 	7	18x40	21rmt.		
TSB1	Threaded steel bar kit-Gewindestange satz-Draadstang set-Kit de tiges filetées-Kit barra filettata-Kit barra roscada 	6	14	2400		
	Backrest-Rückenlehne-Rugleuning-Dossier-Schienale-Respaldo 	2	235x2000			
	Bracket 140x40-Lochplatte-Gatenplaat-Connecteur métallique-Piastre forate-Placas perforadas 	2	140x40			
CI	Ceiling Insulation-Deckelsolation-Plafondisolatie-Isolation du plafond-Isolamento del soffitto-Aislamiento de techo 	2	2190x1095			
	Double door kit ISO-Doppeltür satz-Dubbele deur set-Kit double porte-Kit porta-Kit para puerta 	1	4xφ5x70 2xφ3x25 4xφ5x90			
	Headrest-Kopfstütze-Hoofdsteun-Appui-tête-Poggiatesta-Reposacabezas 	2	395x395			
	Heater Guard-Ofenschutz gitter-Openhaard Guard 	1	562x602			
	Lower Bench-Untere Bank-Onderbank-Banc inférieur-Banco inferiore-Banco inferior 	1	500x2200			
	Lower bench face-Bank unterstützung-Bankje ondersteuning-Dossier banc-Banco schienale-Banco respaldo 	1	395x2200			
	Nail 1.8x40-Nagel-Spijker-Clou-Chiodo-Clavo 	750	1.8x40			
R8x80	Round head bolt kit 8x80-Schloßschraube-Slotbout-Boulon tête ronde-Bulloni testa tonda-Tornillo cabeza redonda 	2	8x80			
	Sauna ventilation kit-Außengitter-Schoepenrooster-Panneau de ventilation-Griglia di ventilazione-Rejilla de ventilacion 	1				
S4x50	Screw 4x50-Schraube-Schroef-Vis-Vite-Tornillo 	30	4x50			
S5x90	Screw 5x90-Schraube-Schroef-Vis-Vite-Tornillo 	45	5x90			
S6x120	Screw 6x120-Schraube-Schroef-Vis-Vite-Tornillo 	30	6x120			
	Upper bench 2-Obere Bank-Bovenbank-Banc supérieur-Banco superiore-Banco superior 	1	600x1600			
	Upper bench face-Bank unterstützung-Bankje ondersteuning-Dossier banc-Banco schienale-Banco respaldo 	1	845x2200			
	Upper bench-Obere Bank-Bovenbank-Banc supérieur-Banco superiore-Banco superior 	1	600x2200			
Kood	Sauna Enns 70	Materjal	File	Sauna Enns 70.dwg	Leht	3/4

Pos	Specification-Spezifikation-Specificatie-Nomenclature-Elementi-Especificacion Sauna Enns 70	Qty	Profile (mm)	Lenght (mm)		
	Ventilation panel kit-Außengitter-Schoepenrooster-Panneau de ventilation-Griglia di ventilazione-Rejilla de ventilacion 	1				
	WINDOW 1540x1900 DW08U F 1540x1900-70 ISO 	1				
	WINDOW 578x825 WR 825x825-70 ISO TEMPERED 	1				
	DOOR 1540x1900 DD08 F 1540x1900-70 ISO 	1				
	DOOR 690x1900 SD Sauna 690x1900-70 L 	1				
	Sauna door trim board 	4	28x95	1850		
	Sauna door trim board 	2	28x95	900		
	Screw-Schraube-Schroef 4x60 	25				
Kood	Sauna Enns 70	Materjal	File	Sauna Enns 70.dwg	Leht	4/4

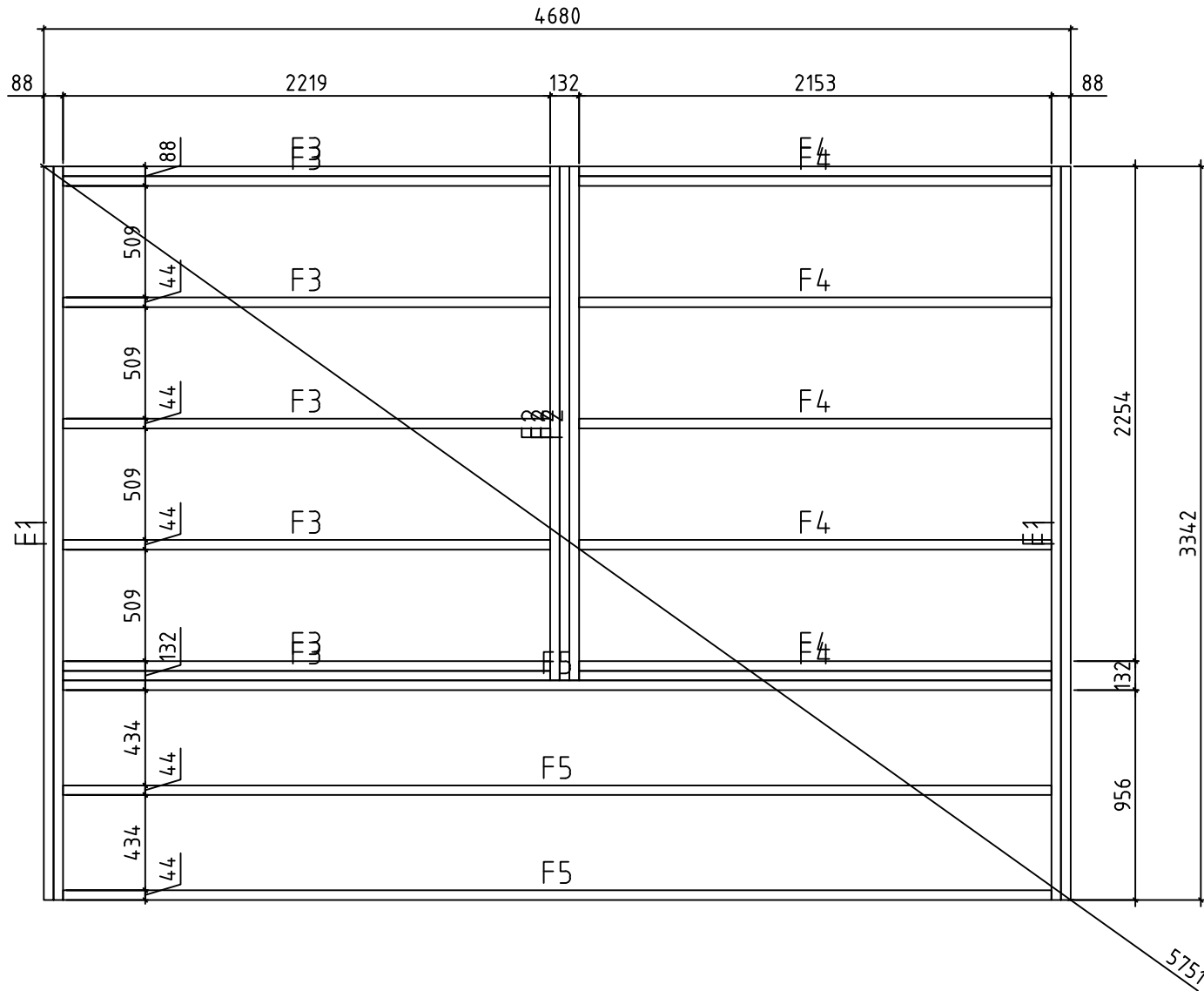

0 0.5m 1.0m 2.0m

Model	Sauna Enns 70	Drawing	FOUNDATION	Page
	Drawn by	R.T	Material	70x135
	Date	26.03.2024	File	Sauna Enns 70.dwg
				Scale
				1:30

H = 1.700 m
TOTAL: 13.55 m²

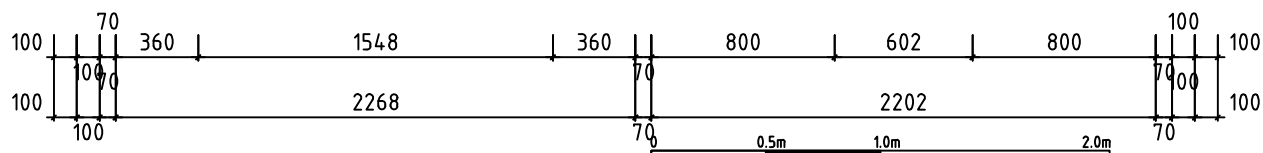
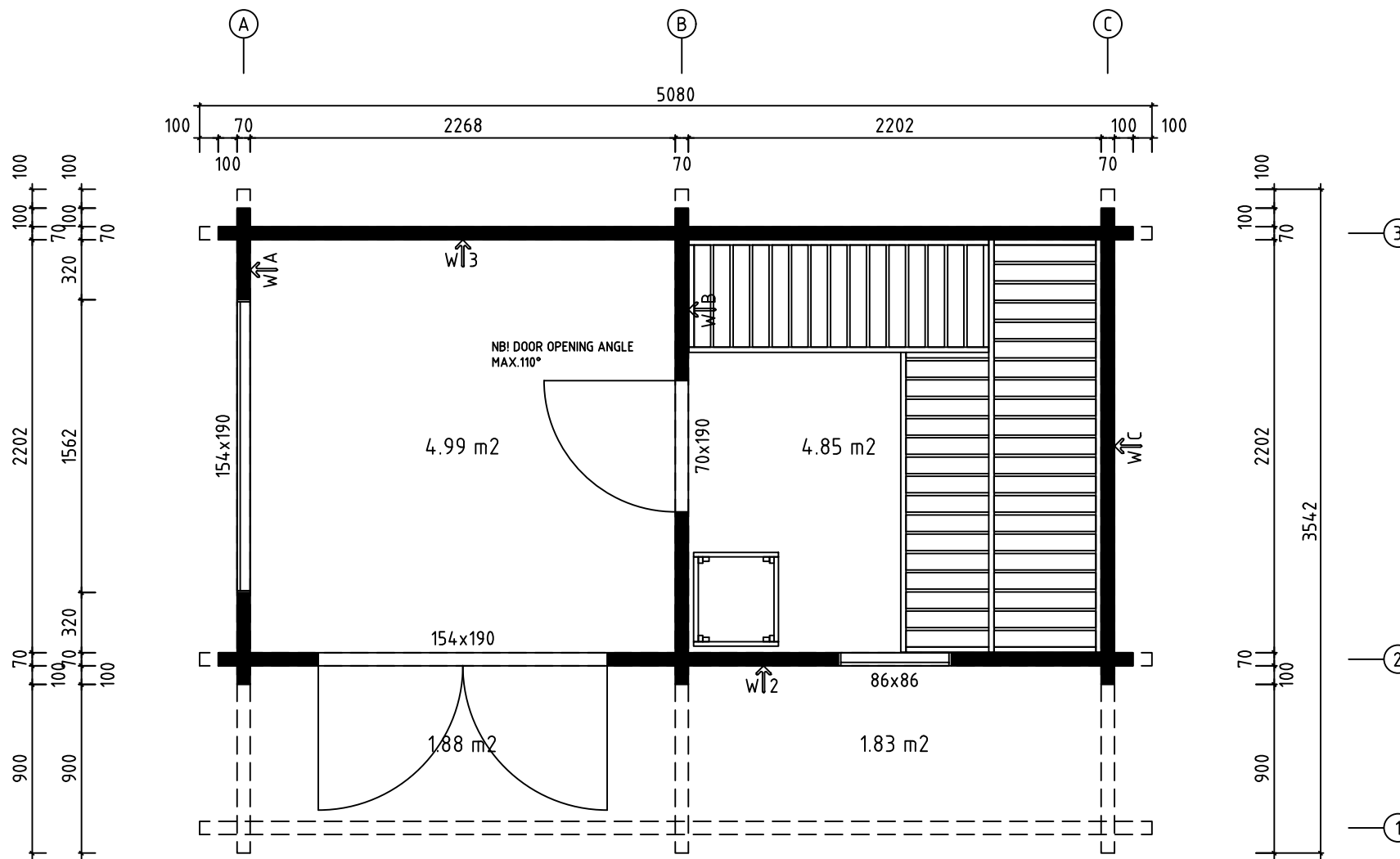

Model	Sauna Enns 70		Drawing	PLAN	Page			
			Drawn by	R.T	Material	70x135	Scale	1:30
			Date	26.03.2024	File	Sauna Enns 70.dwg		

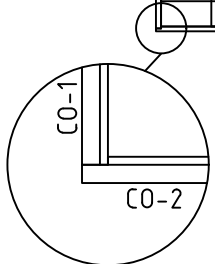
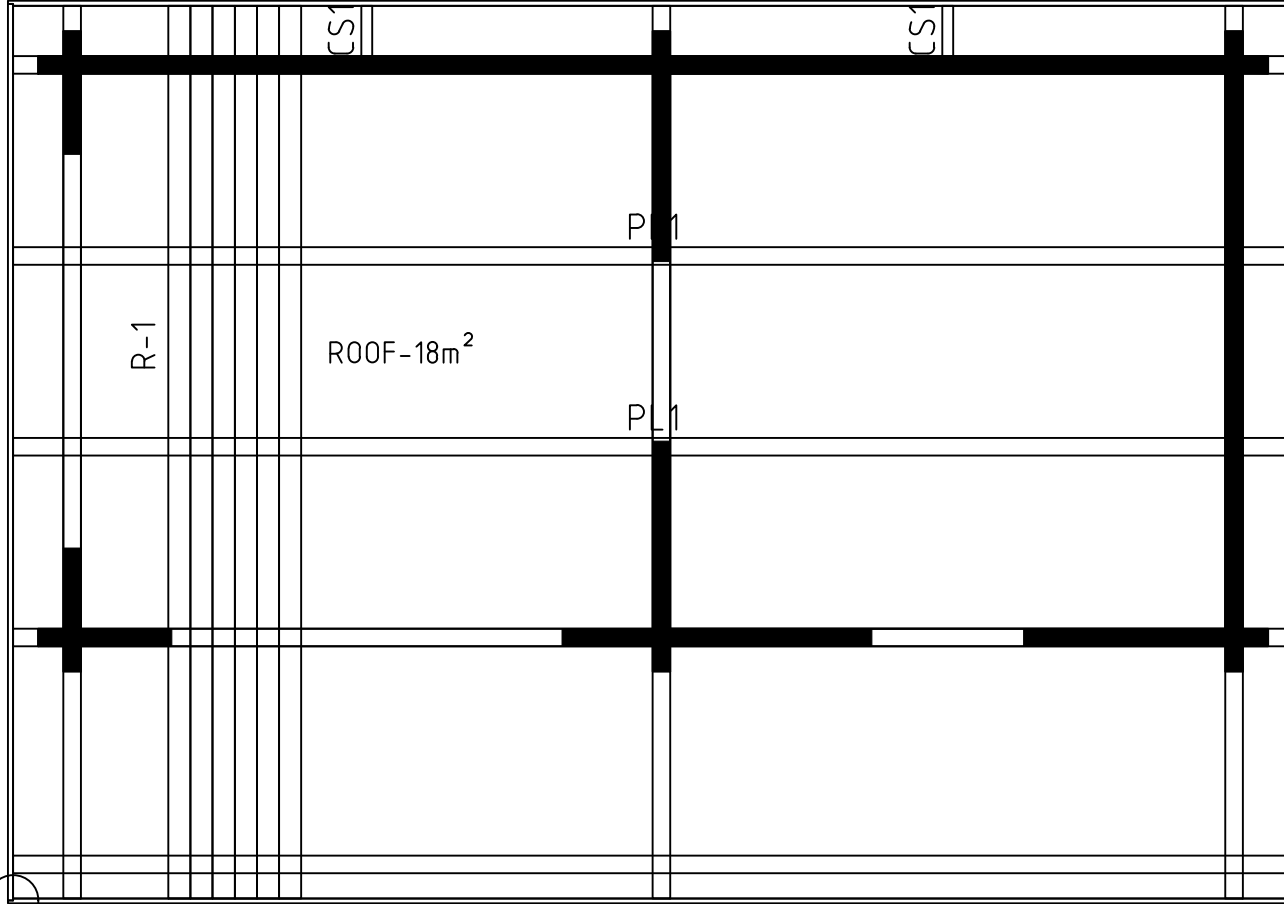

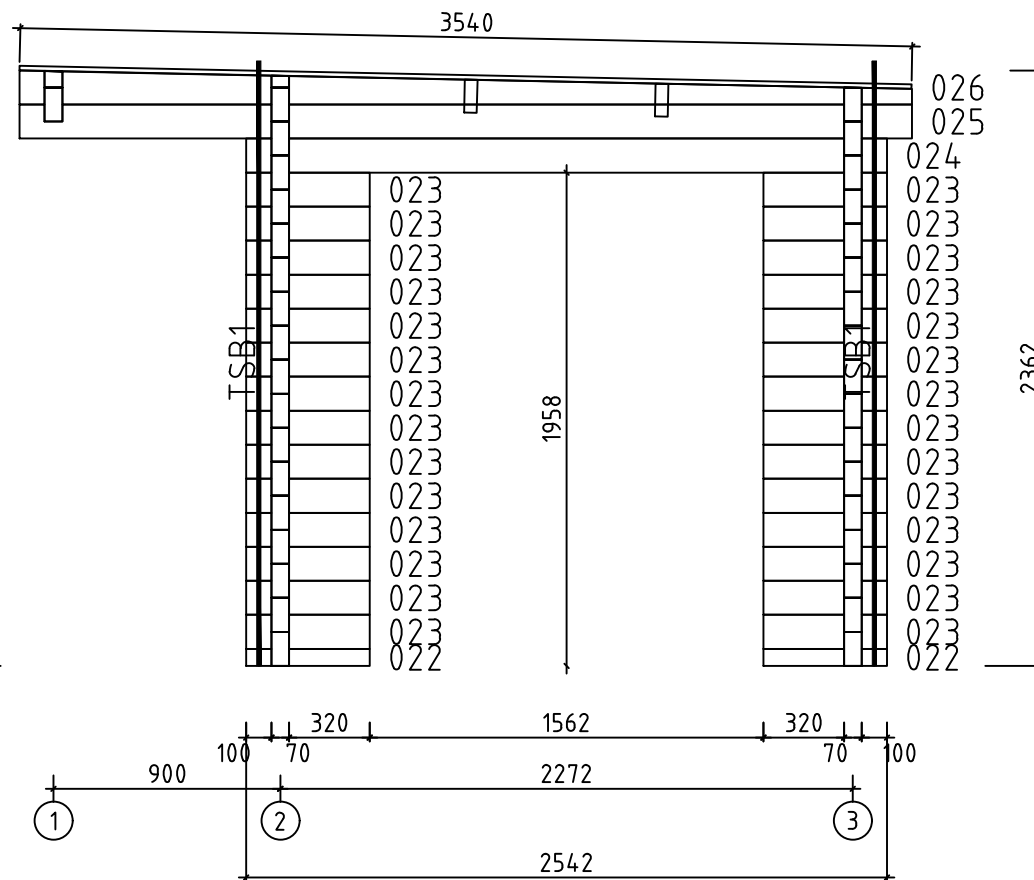
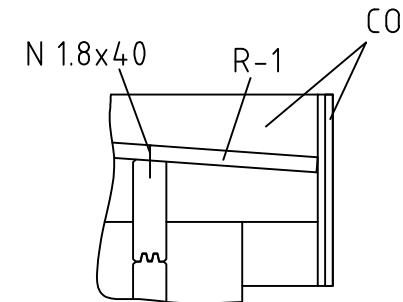
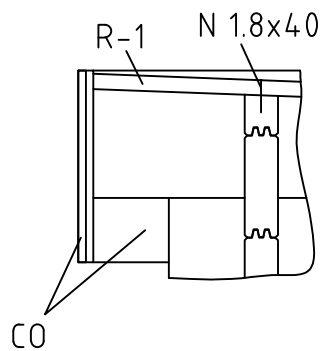

0 0.5m 1.0m 2.0m

Model	Sauna Enns 70	Drawing	ROOF	Page	
	Drawn by	R.T	Material	70x135	Scale
	Date	26.03.2024	File	Sauna Enns 70.dwg	

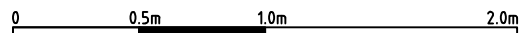

Wall-Wand A ↗



Model	Sauna Enns 70		Drawing	WALL A		Page	4
	Drawn by	R.T	Material	7x13.5		Scale	1:30
	Date	26.03.2024	File	Sauna Enns 70.dwg			

Wall-Wand B ↗

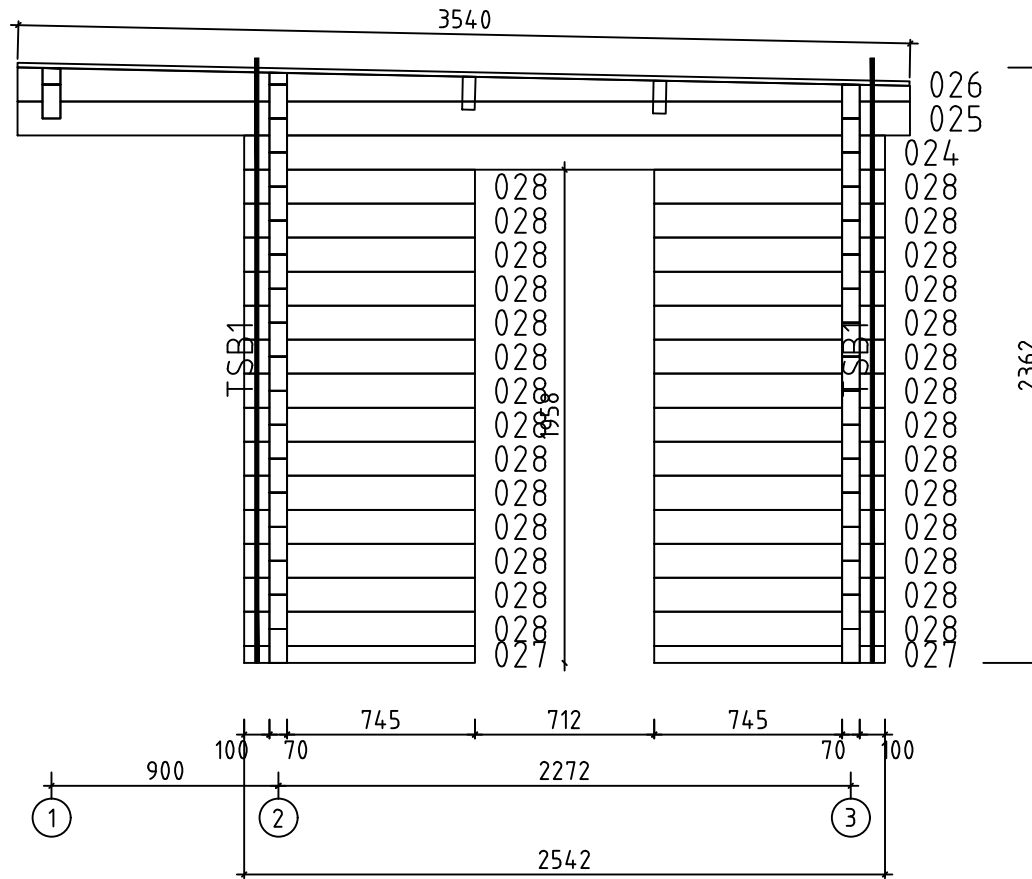

0 0.5m 1.0m 2.0m

Model	Sauna Enns 70	Drawing	WALL B	Page	5	
Alpholz	Drawn by	R.T	Material	7x13.5	Scale	1:30
	Date	26.03.2024	File	Sauna Enns 70.dwg		

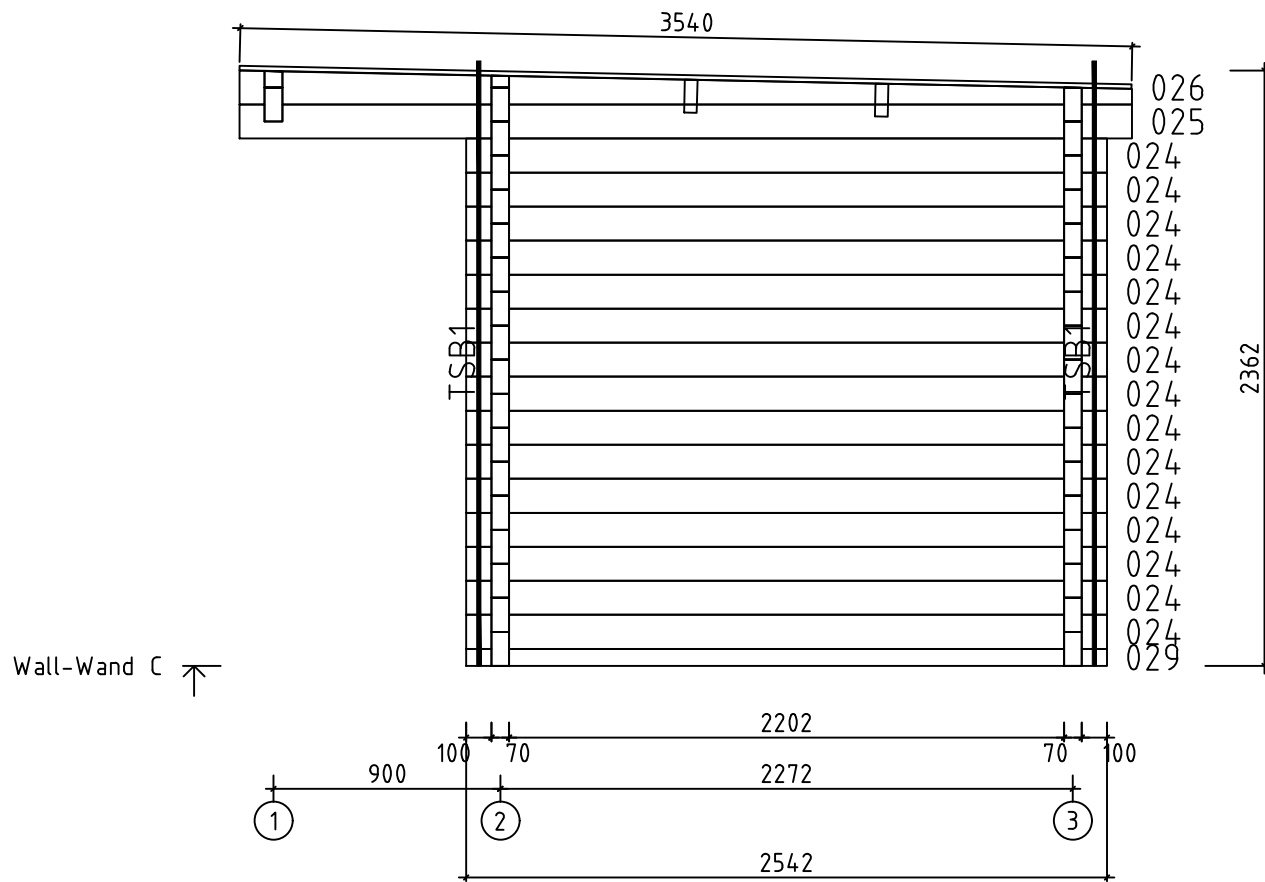

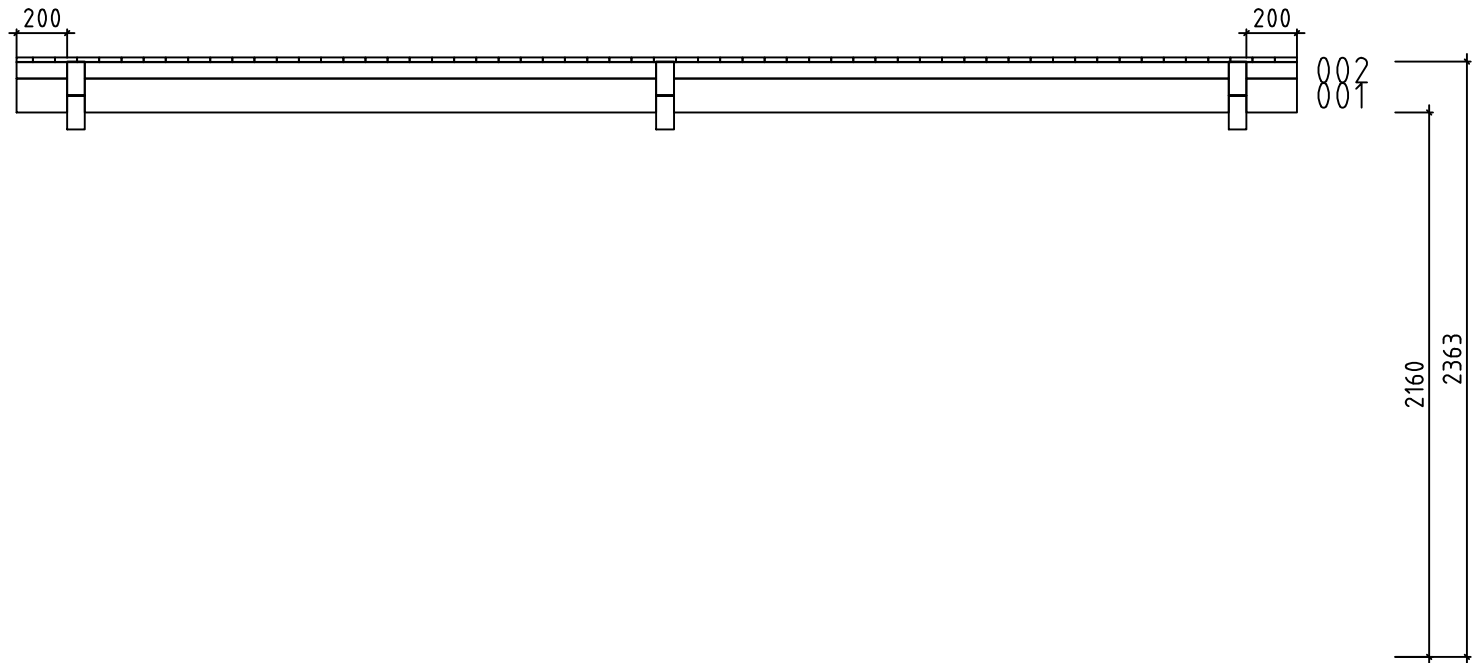
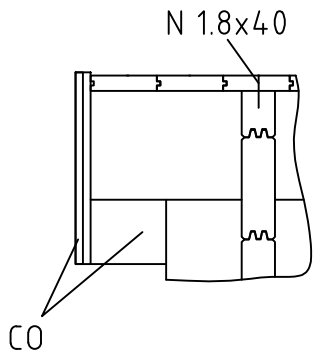

0 0.5m 1.0m 2.0m

Model	Sauna Enns 70	Drawing	WALL C	Page	6	
	Drawn by	R.T	Material	7x13.5	Scale	1:30
	Date	26.03.2024	File	Sauna Enns 70.dwg		

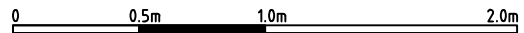
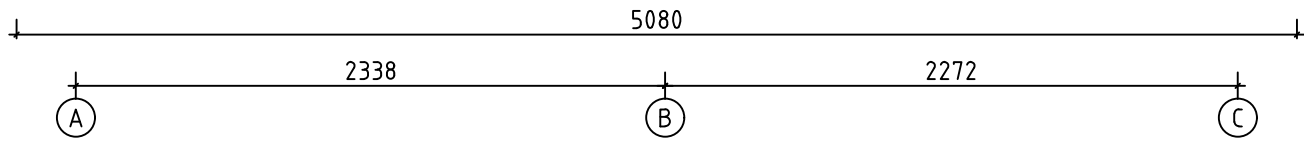

Wall-Wand 1 ↗



Model	Sauna Enns 70	Drawing	WALL 1	Page	7	
	Drawn by	R.T	Material	7x13.5	Scale	1:30
	Date	26.03.2024	File	Sauna Enns 70.dwg		

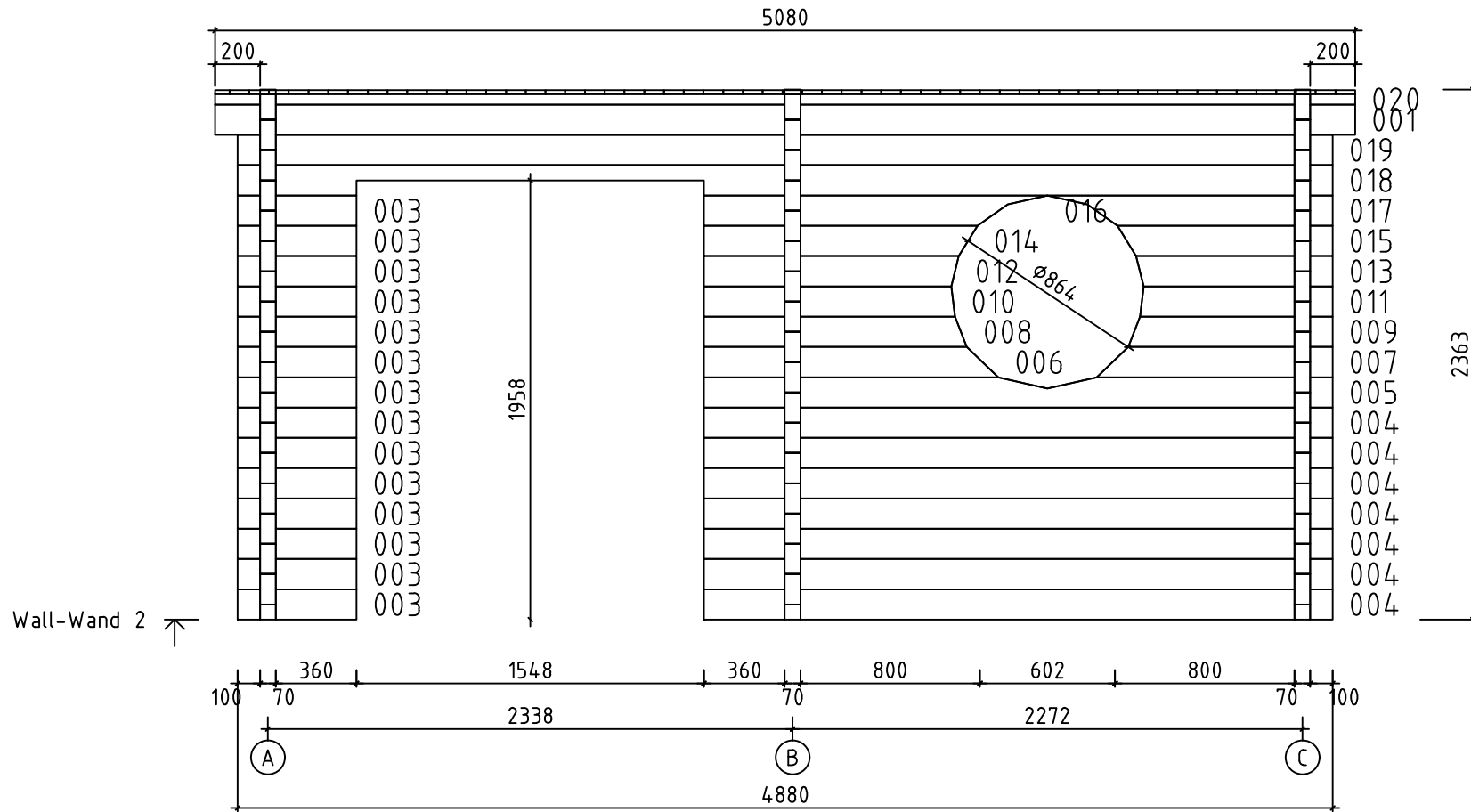

Wall-Wand 2 ↗

0 0.5m 1.0m 2.0m

Model	Sauna Enns 70	Drawing	WALL 2	Page	8	
	Drawn by	R.T	Material	7x13.5	Scale	1:30
	Date	26.03.2024	File	Sauna Enns 70.dwg		

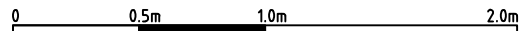
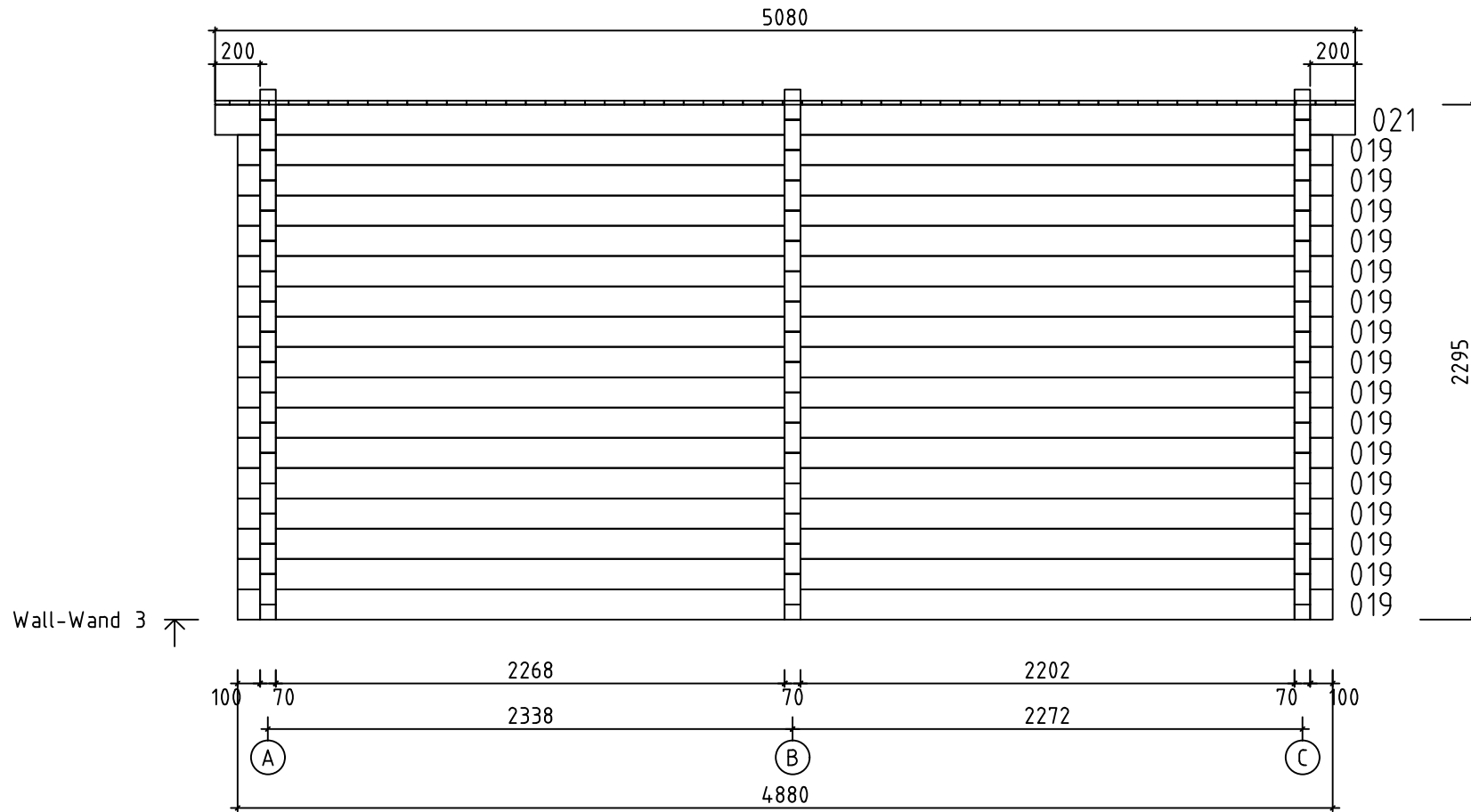

Model	Sauna Enns 70	Drawing	WALL 3	Page	9	
	Drawn by	R.T	Material	7x13.5	Scale	1:30
	Date	26.03.2024	File	Sauna Enns 70.dwg		