

Alpho**l**

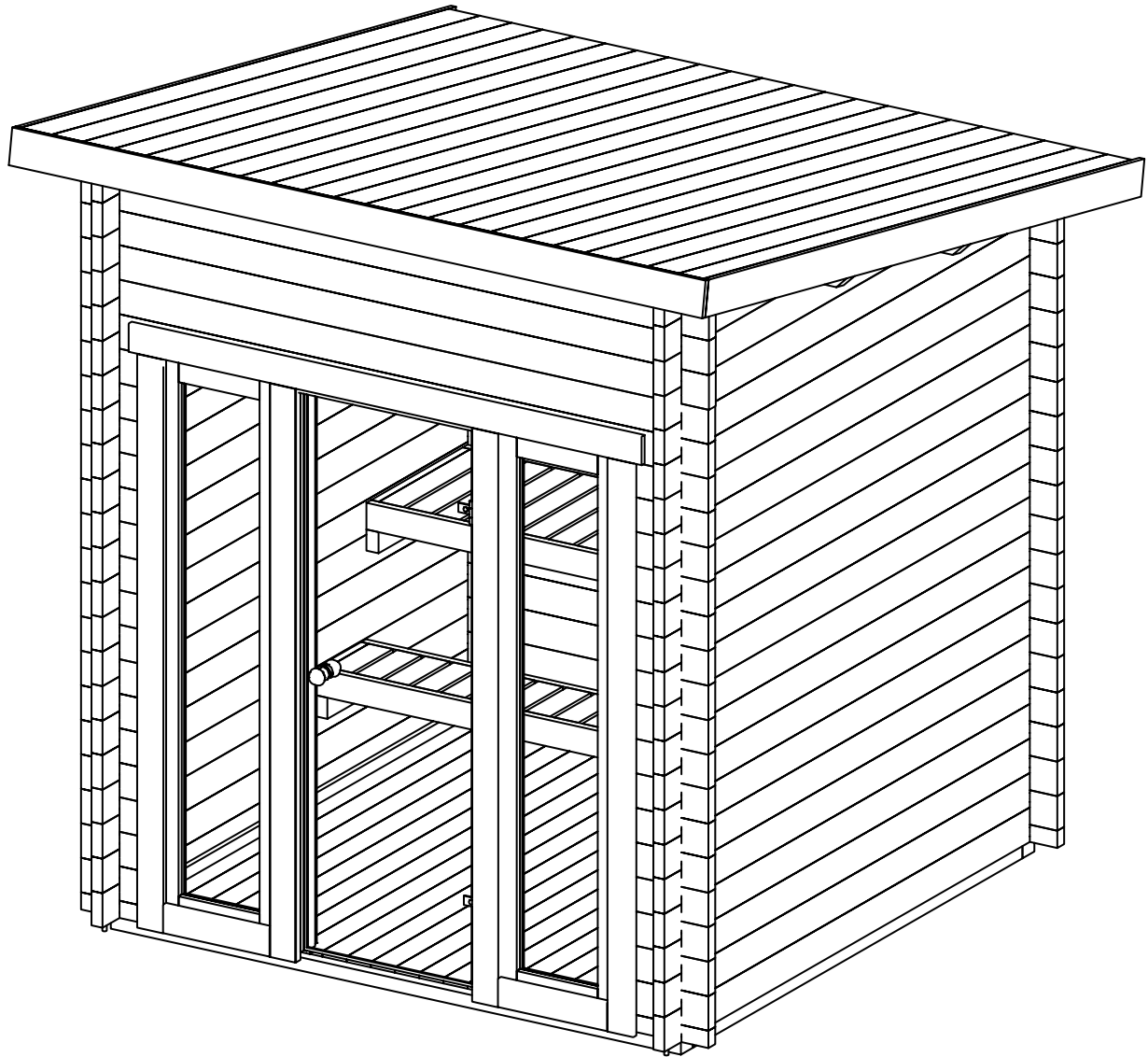

Sauna Lizzy 40 XXS

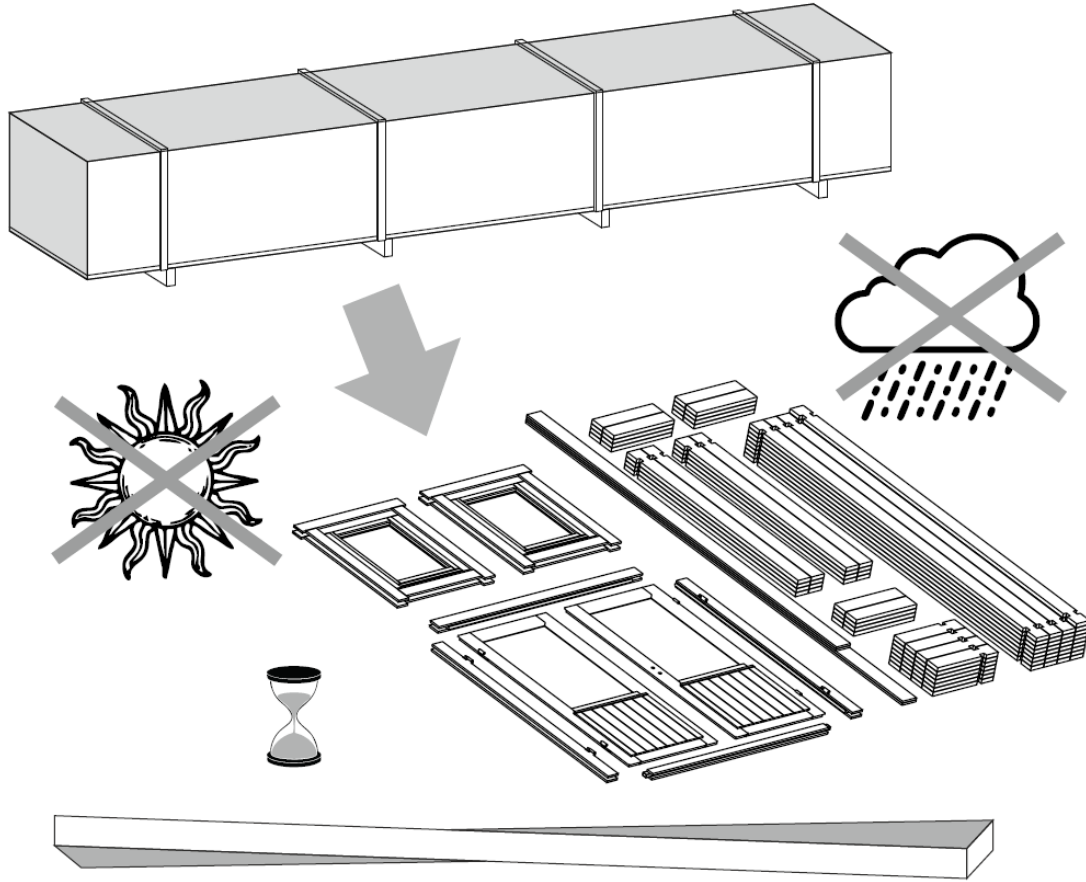

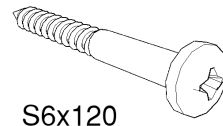
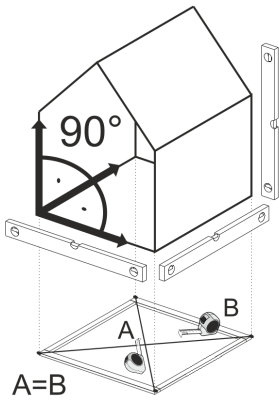

S6x120

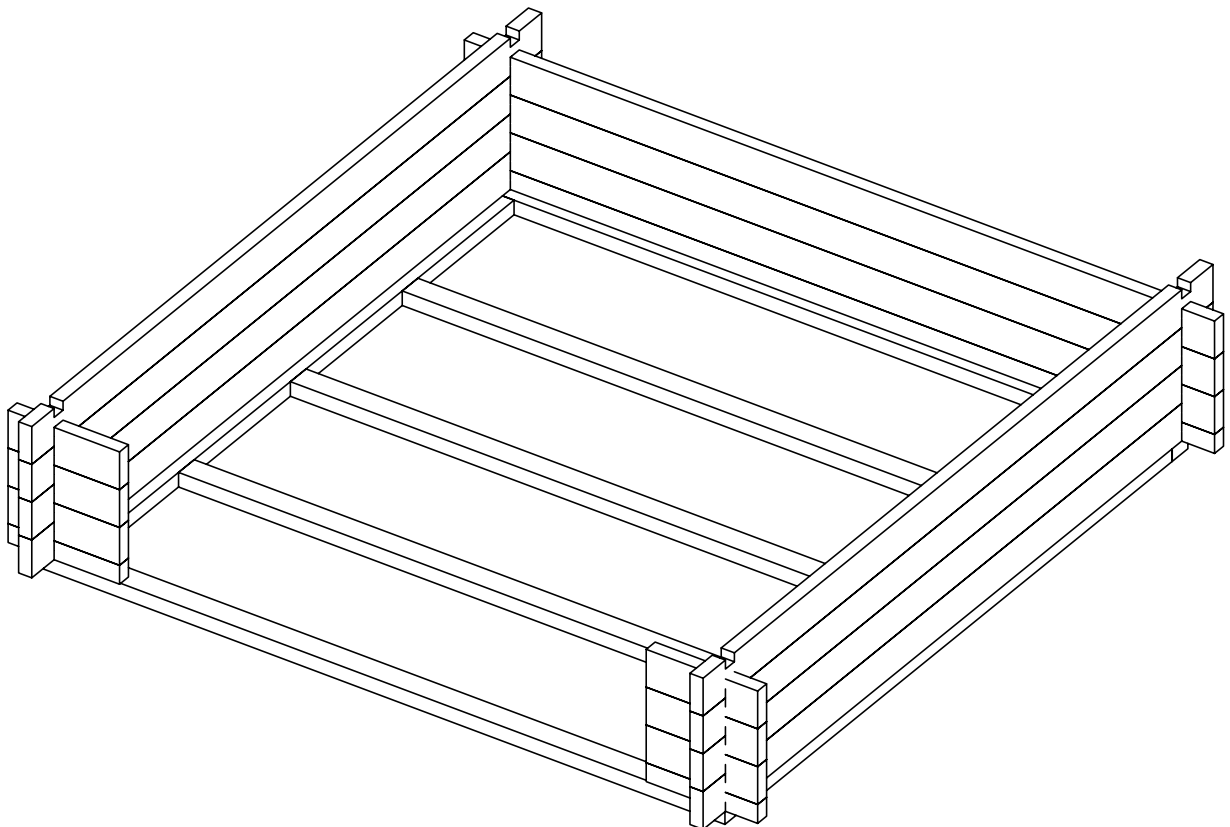
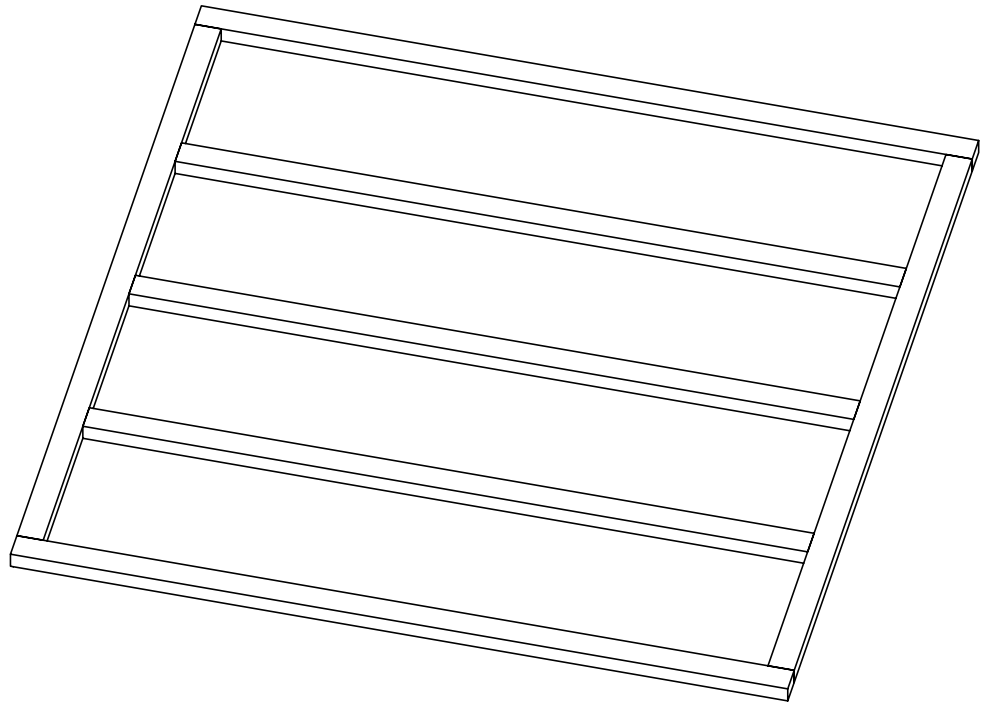
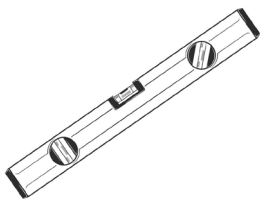
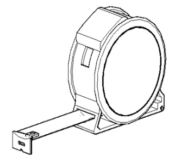

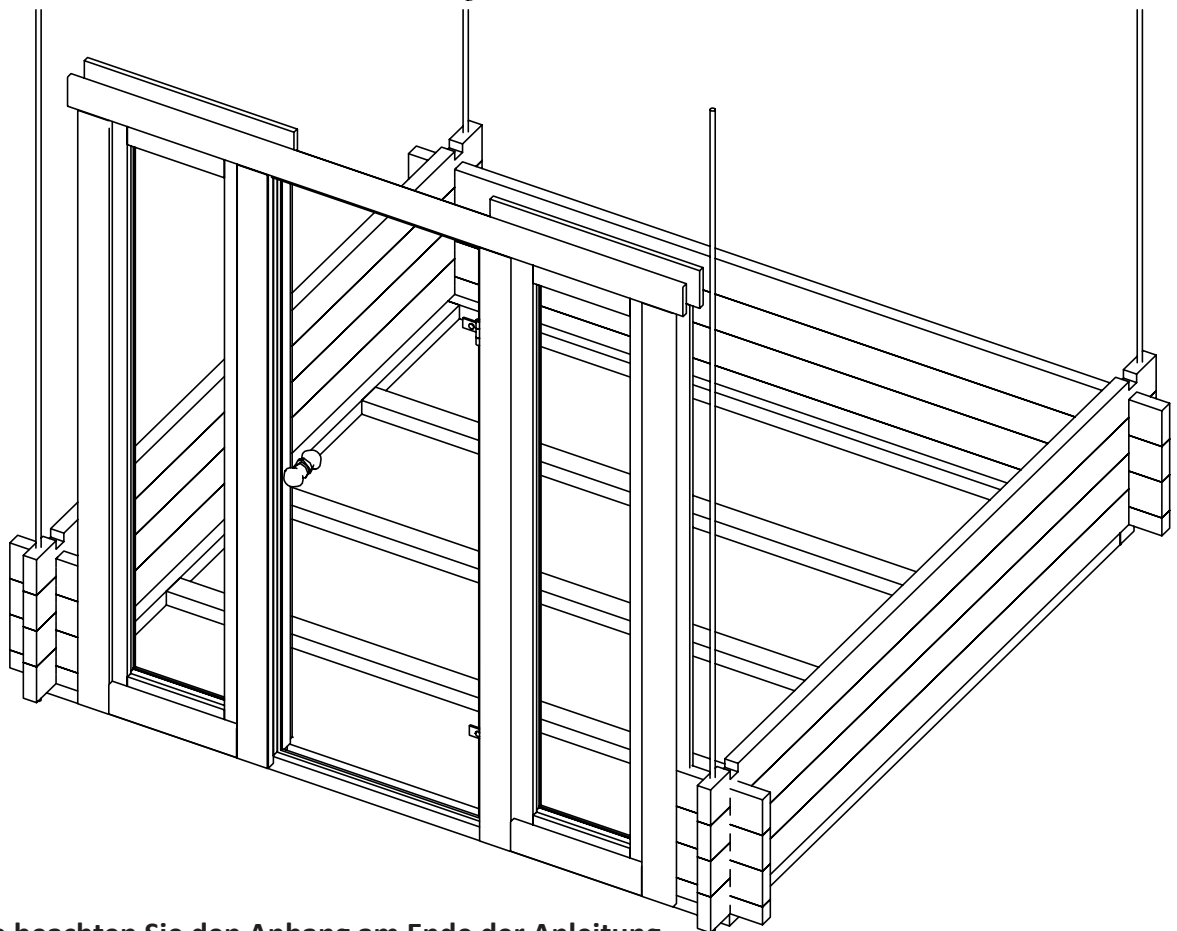
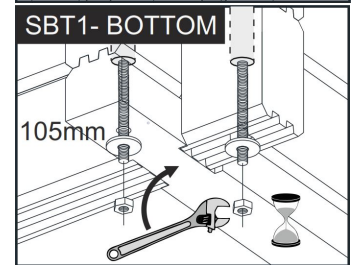
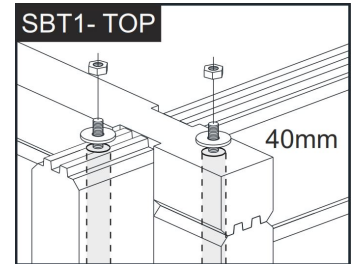
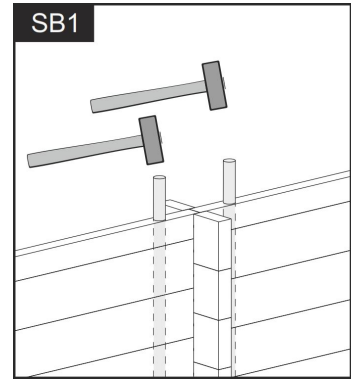
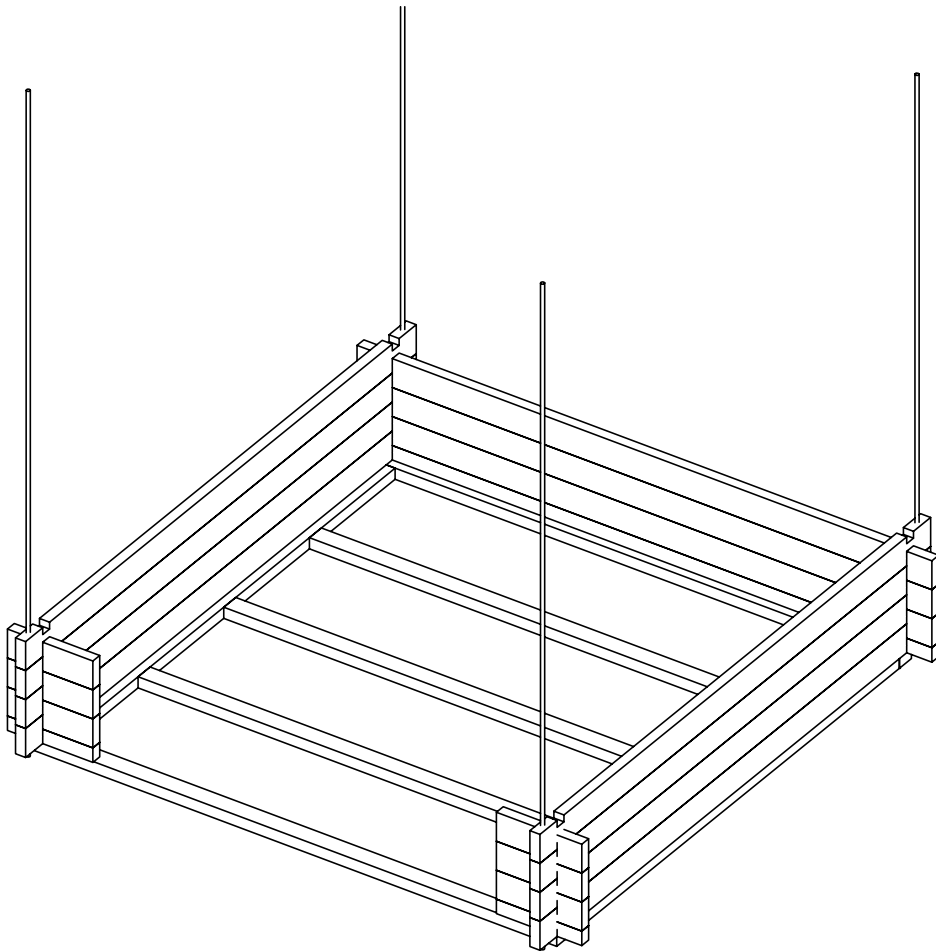

**2** Bitte beachten Sie den Anhang am Ende der Anleitung.  
Please refer to the appendix of this section.

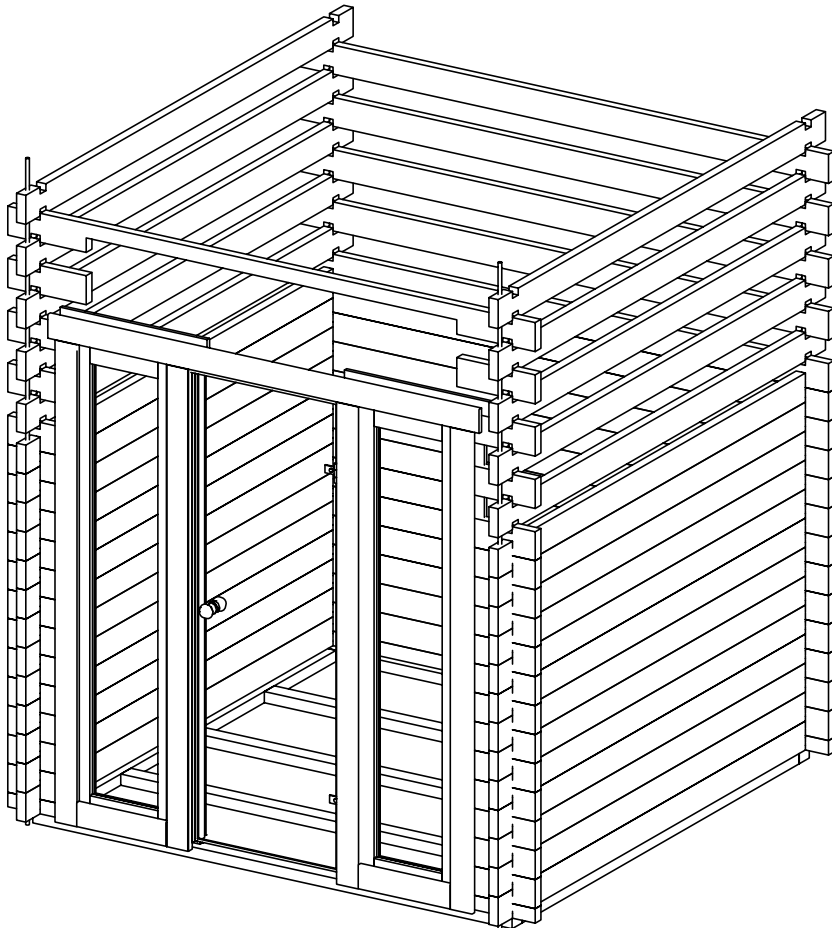
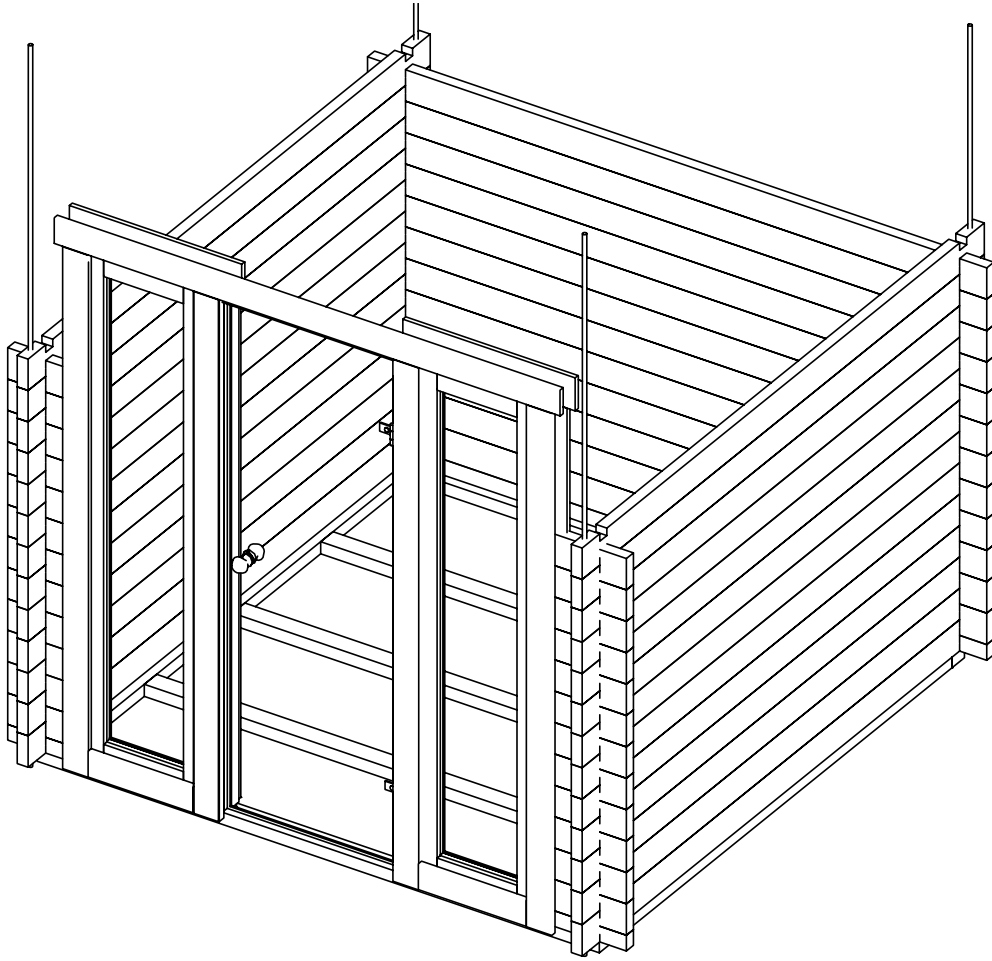

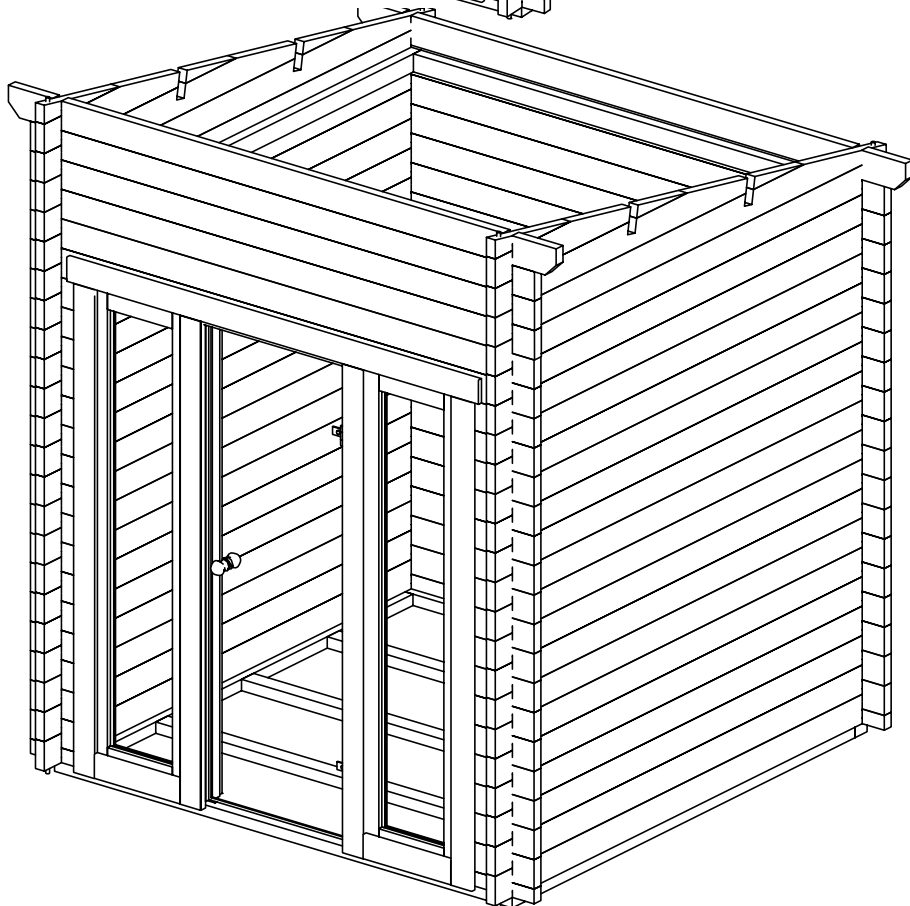
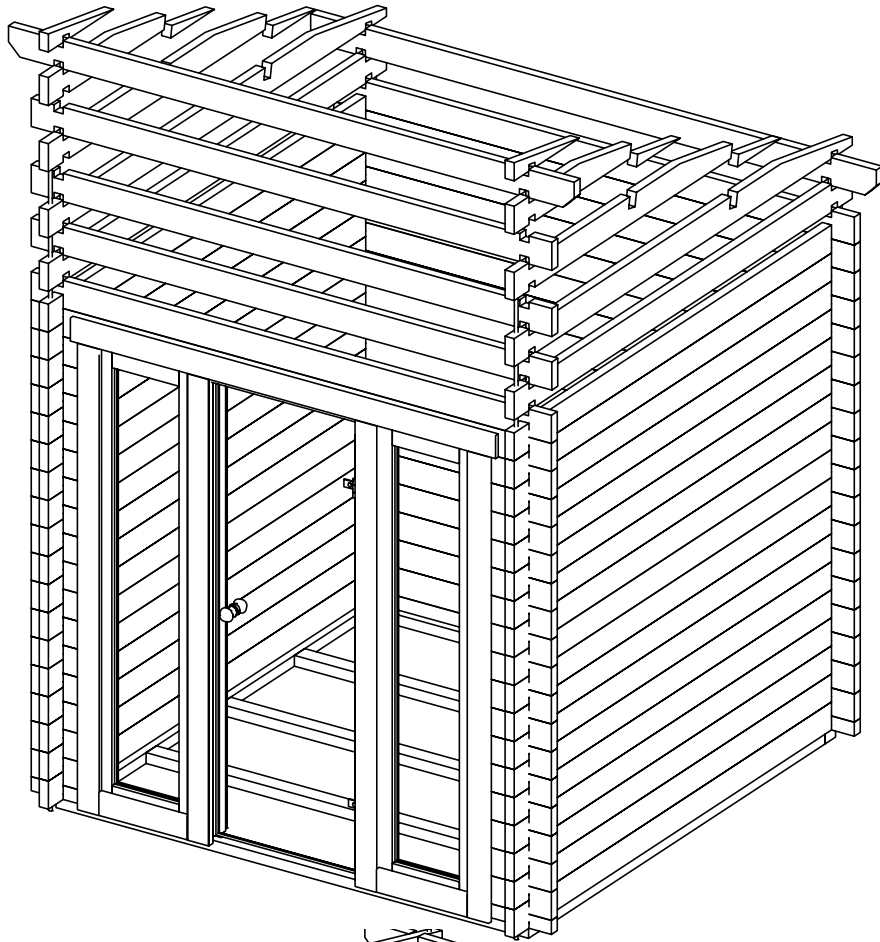

**4** Bitte beachten Sie den Anhang am Ende der Anleitung.  
Please refer to the appendix of this section.

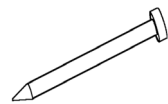
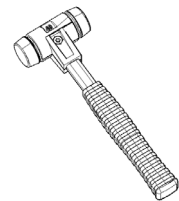
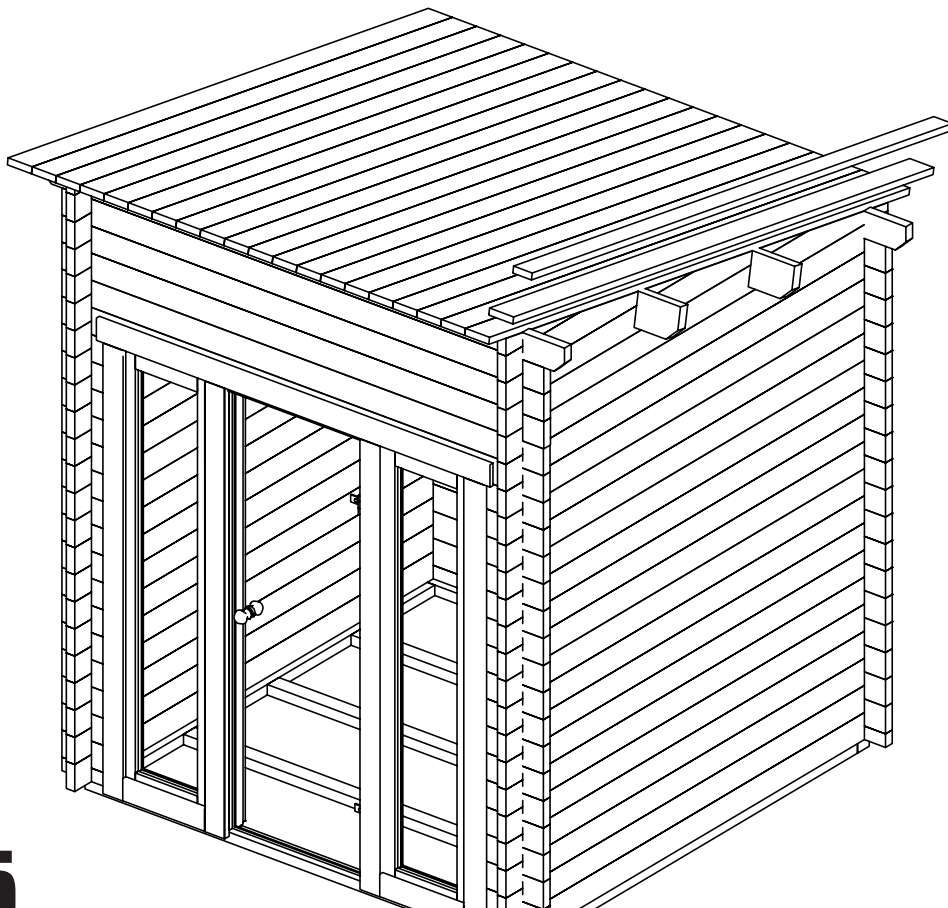
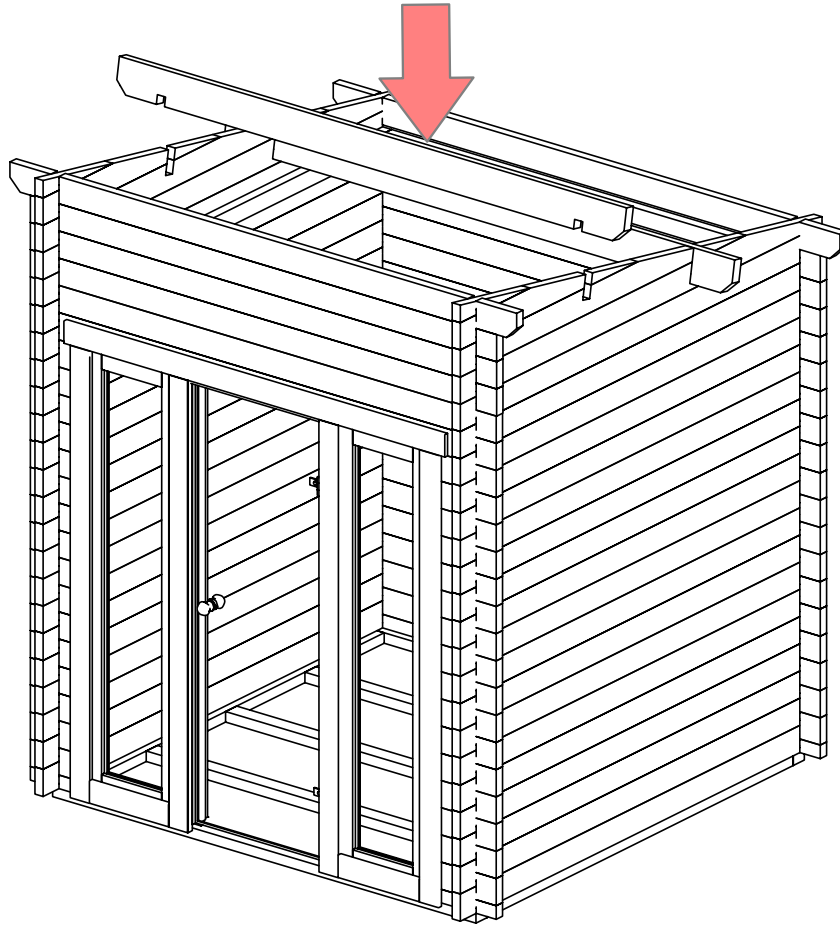

N1,8x40

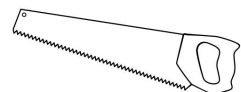

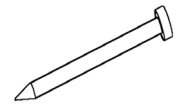
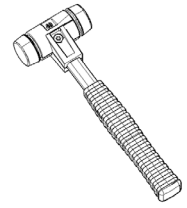
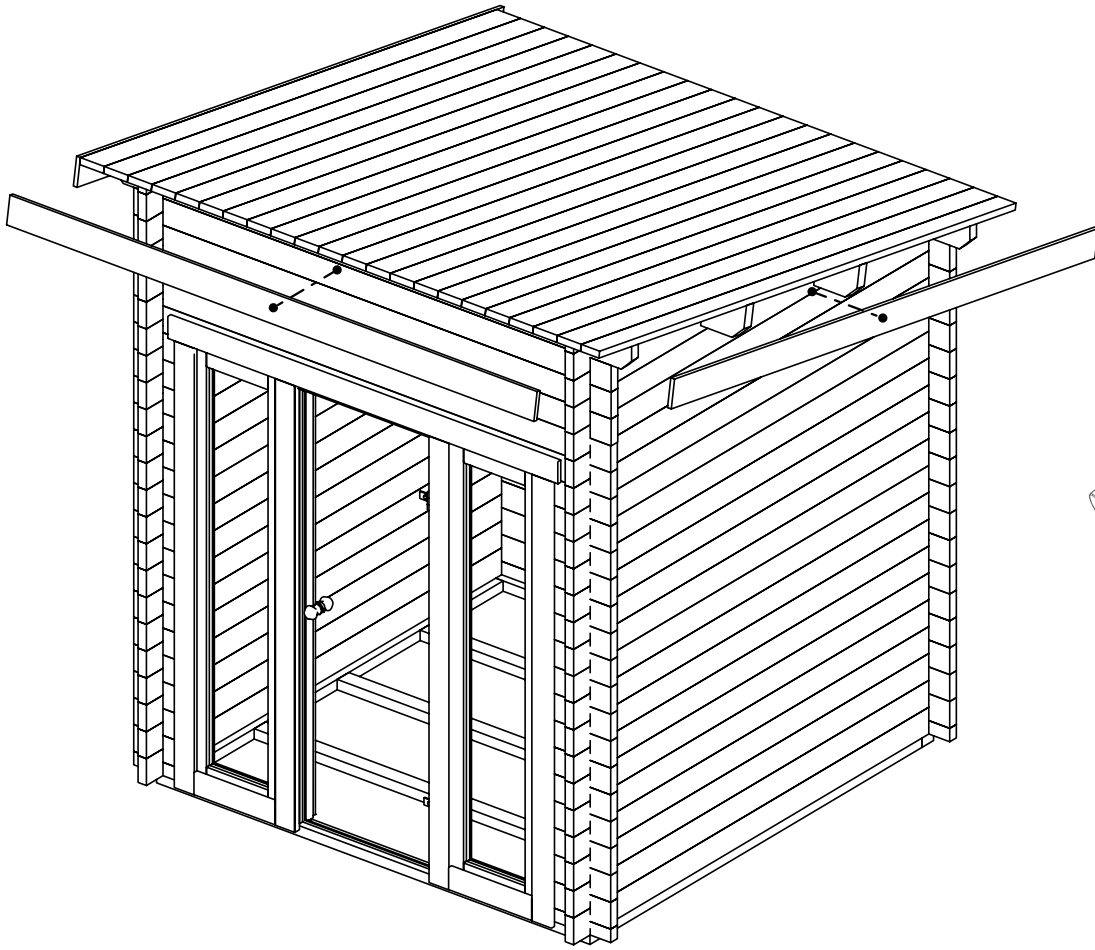

N1,8x40

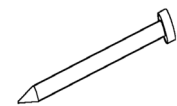
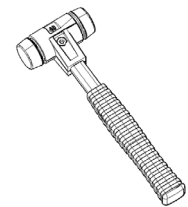
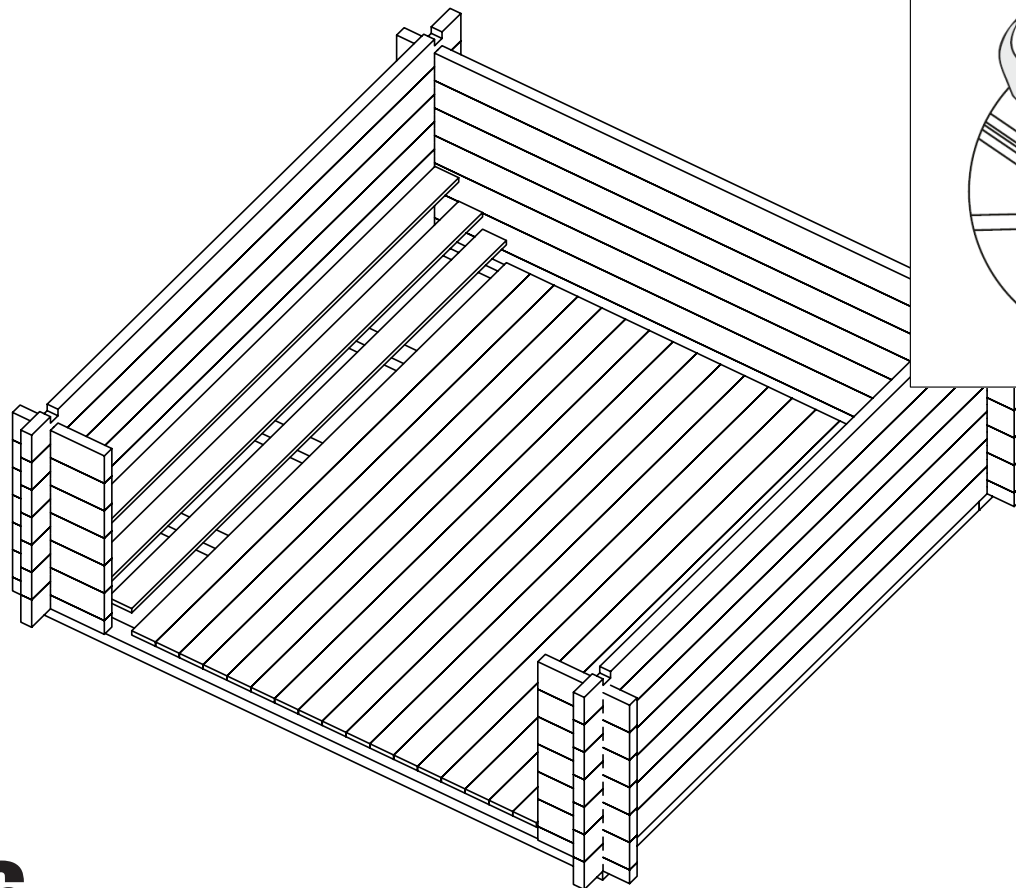
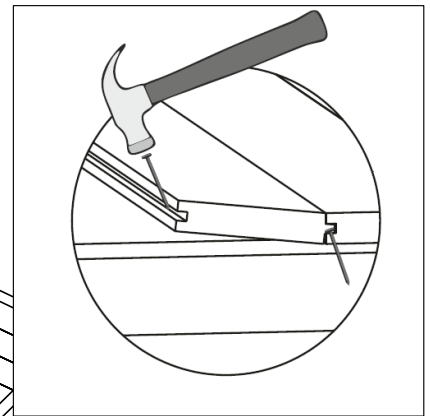

N1,8x40



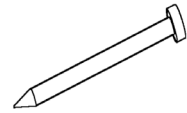
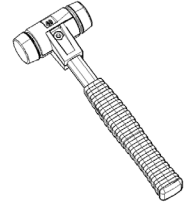
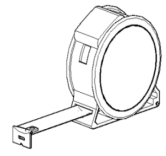
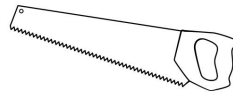
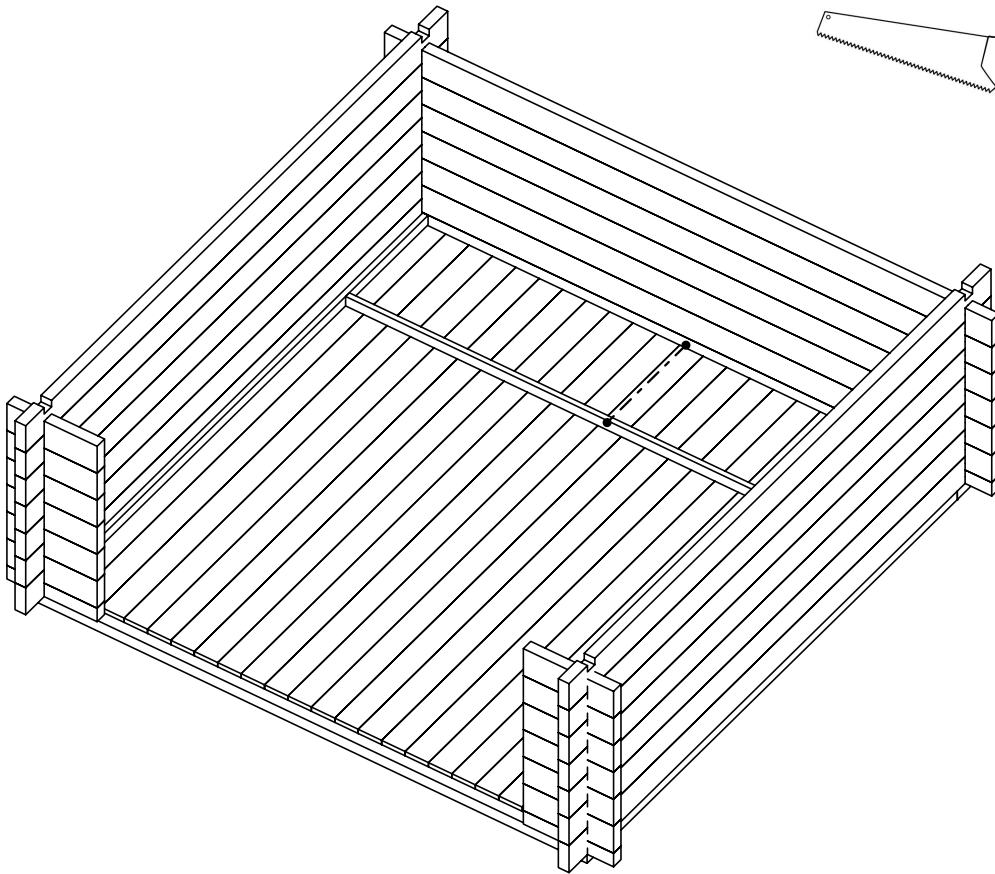

N1,8x40

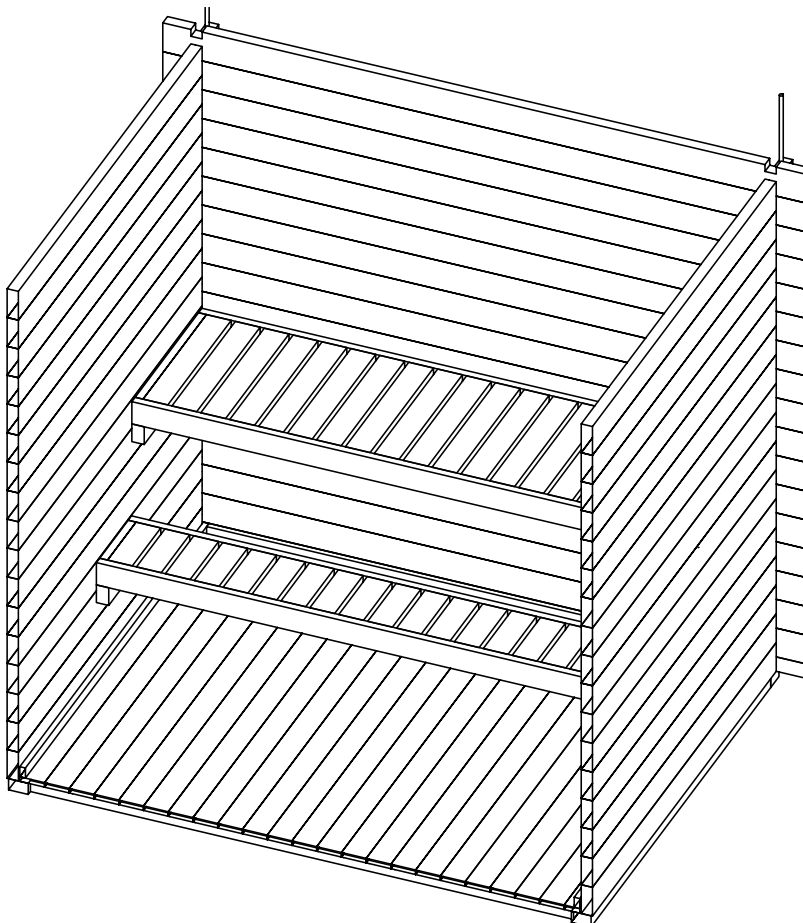

**Bitte beachten Sie den Anhang am Ende der Anleitung.  
Please refer to the appendix of this section.**

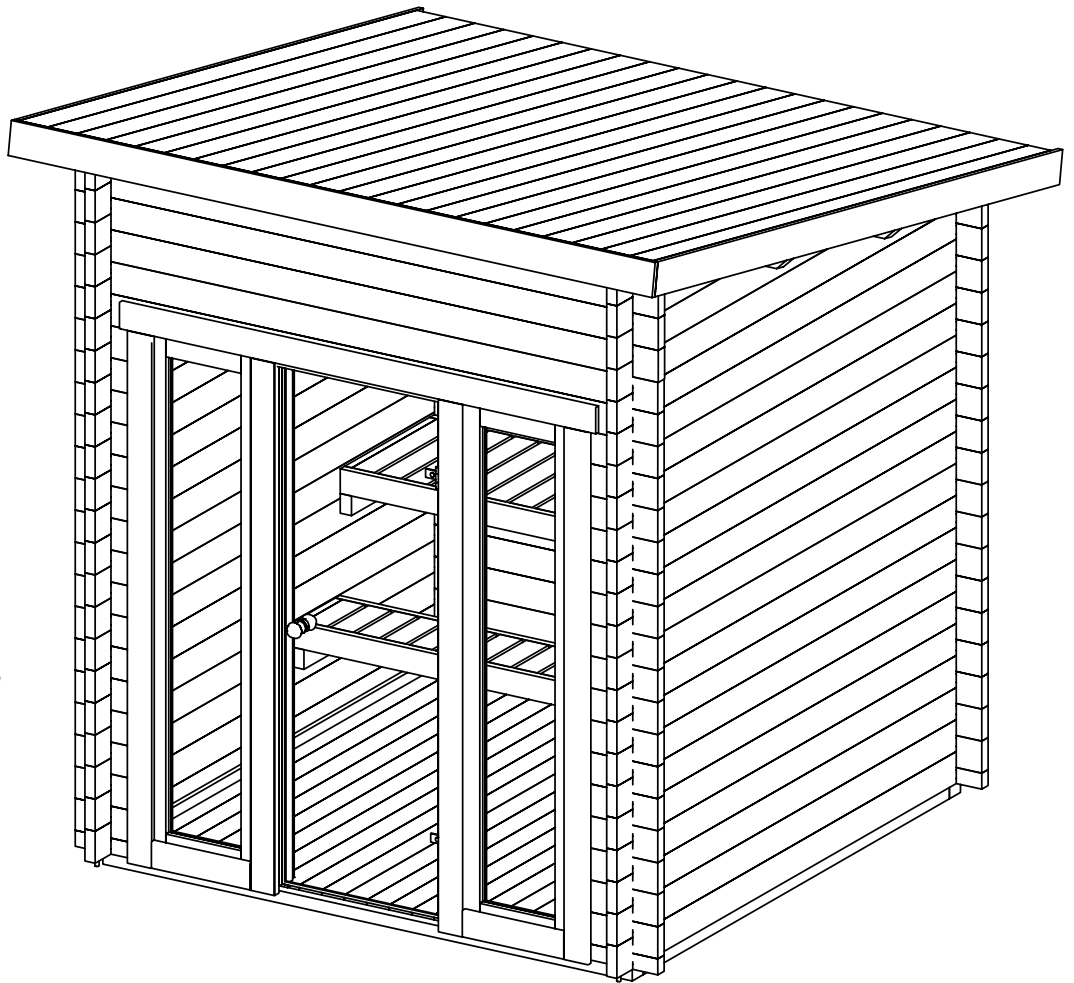
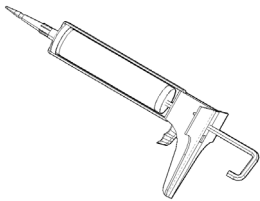
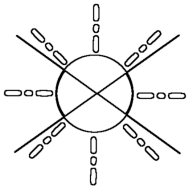
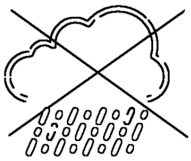

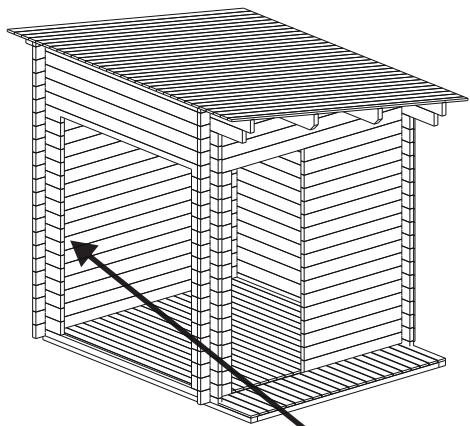

4x60

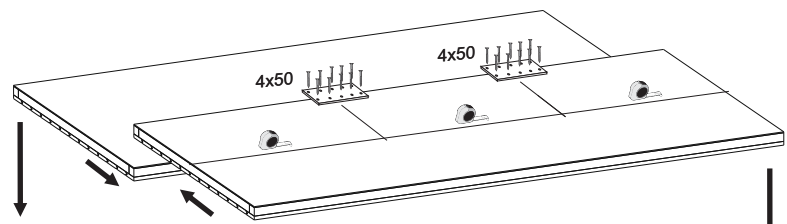
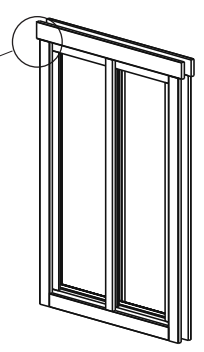
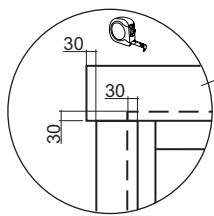

4x50

4x50

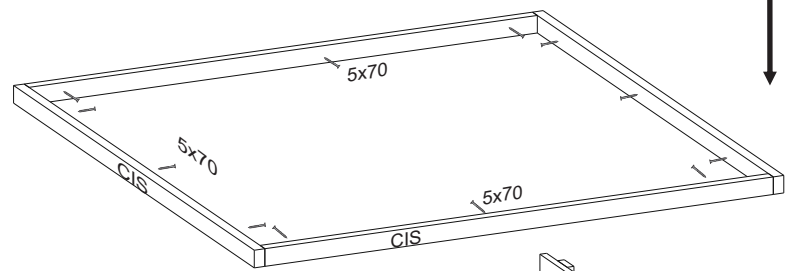

5x70

CIS

5x70

CIS

5x70

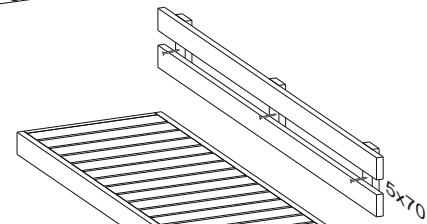

5x70

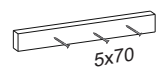

5x70

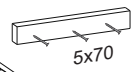
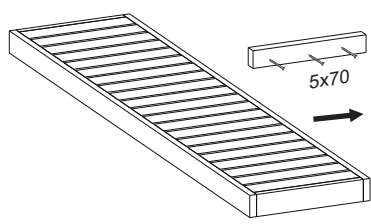

5x70

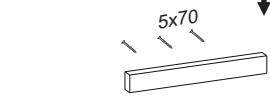

5x70

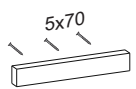

5x70

NB! Before roofing

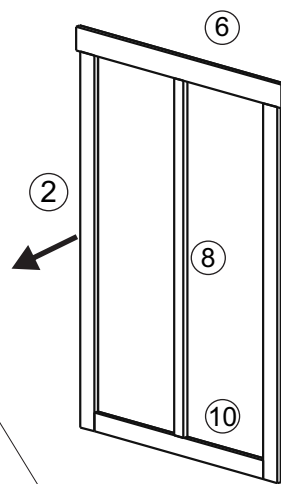

12

2

8

10

6



4x60

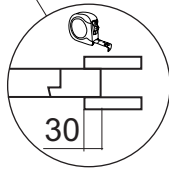

30

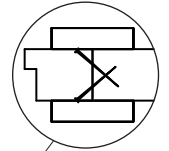

3

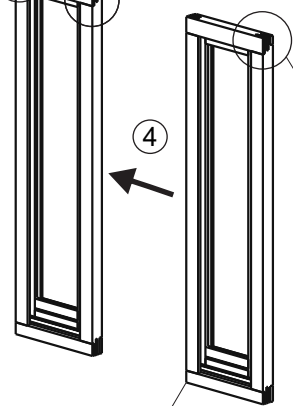

4

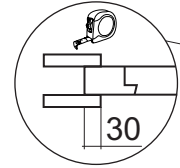

30

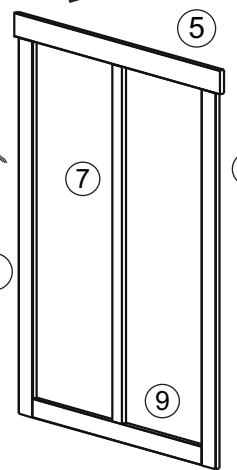

1

5

7

9

11



4x60

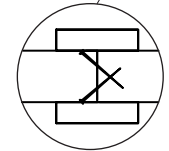



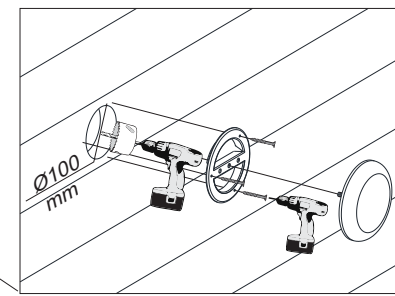
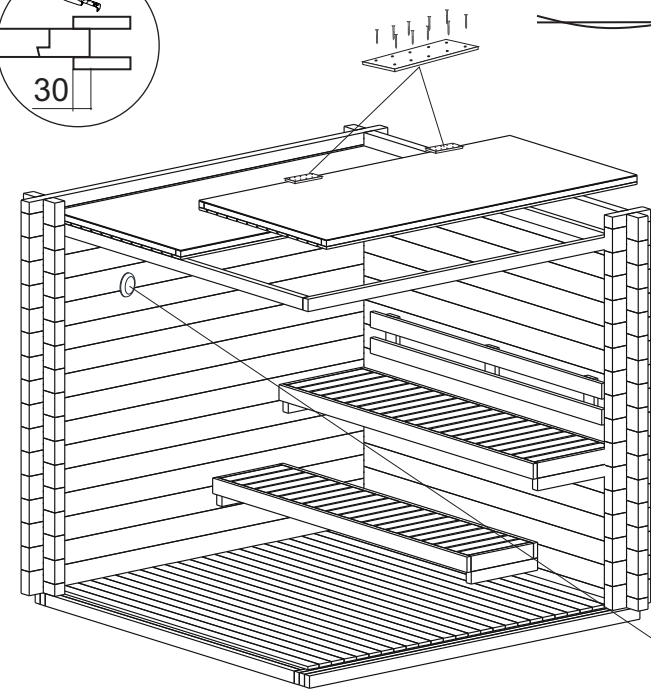





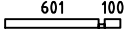

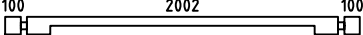
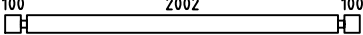
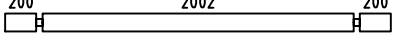
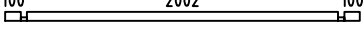
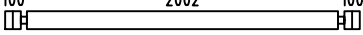
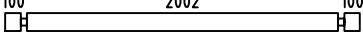
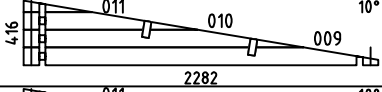
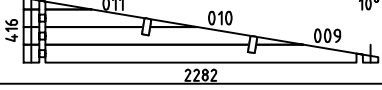





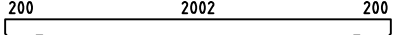

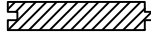



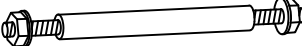

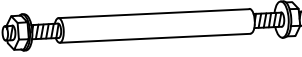

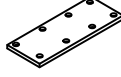



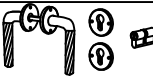

4x60

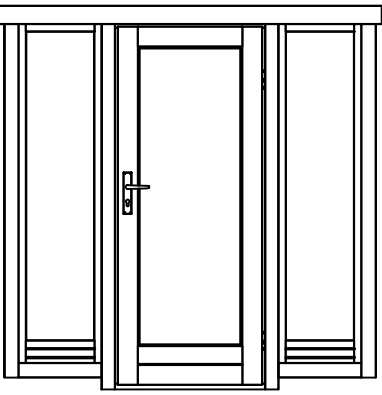

Ø100 mm

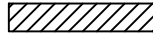

Pos	Specification-Spezifikation-Specificatie-Nomenclature-Elementi-Especificacion Sauna Lizzy40 XXS	Qty	Profile (mm)	Lenght (mm)		
001		2	40x57	741		
002		32	40x114	290		
003		1	40x114	2282		
004		22	40x114	2282		
005		2	40x114	2482		
006		1	40x57	2282		
007		38	40x114	2282		
EXTRA		1	40x114	2282		
WA-1		1				
WB-1		1				
F2	FOUNDATION-FUNDAMENT-FONDATION-FONDAZIONE-VIGAS DE CIMENTACIÓN 	2	70x44	2072		
F1	FOUNDATION-FUNDAMENT-FONDATION-FONDAZIONE-VIGAS DE CIMENTACIÓN 	5	70x44	1932		
UBS2	UPPER BENCH SUPPORT-TRAGELEISTE-STEUNEN BAR-SUPPORT-SUPPORTO-SOPORTE 	2	44x70	595		
UBS1	UPPER BENCH SUPPORT-TRAGELEISTE-STEUNEN BAR-SUPPORT-SUPPORTO-SOPORTE 	2	44x70	295		
CIS1	CEILING INSULATION SUPPORT-TRAGELEISTE-STEUNEN BAR-SUPPORT-SUPPORTO-SOPORTE 	2	44x70	2000		
CIS2	CEILING INSULATION SUPPORT-TRAGELEISTE-STEUNEN BAR-SUPPORT-SUPPORTO-SOPORTE 	2	44x70	1912		
PL1	PURLIN-DAKBALK-DACHPFETTE-PANNE-ARCARECCIO-CORREA 	2	44x144	2482		
F-1	Floor board-Fussbodenbrett-Vloerplank-Lame de plancher-Tavola pavimento-Tabla de suelo 	23+1 18+1	88x18 114x18	1992		
R-1	Roof board-Dachbrett-Dakplank-Volige-Tavola tetto-Tabla de tejado 	29+1 22+1	88x18 114x18	2550		
FLB-1	Floor beading 2000-Fussbodenleiste-Plinten-Moulure de finition-Listello pavimento-Liston de suelo 	4	18x40	8 rmt		
GB-1	Gable board 120-Giebelblende-Gevelplank-Planche de rive-Tavola di bordo-Tabla de borde 	2	18x120	2522		
GB-2	Gable board 120-Giebelblende-Gevelplank-Planche de rive-Tavola di bordo-Tabla de borde 	2	18x120	2590		
TSB1	Threaded steel bar kit-Gewindestange satz-Draadstang set-Kit de tiges filetées-Kit barra filettata-Kit barra roscada 	2	14	2620		
Kood	Sauna Lizzy 40 XXS	Materjal	File	Sauna Lizzy 40 XXS.dwg	Leht	1/2

Pos	Specification-Spezifikation-Specificatie-Nomenclature-Elementi-Especificacion Sauna Lizzy40 XXS	Qty	Profile (mm)	Lenght (mm)		
TSB2	Threaded steel bar kit-Gewindestange satz-Draadstang set-Kit de tiges filetées-Kit barra filettata-Kit barra roscada 	2	14	2250		
	Backrest-Rückenlehne-Rugleuning-Dossier-Schienale-Respaldo 	1	235x1800			
	Bracket 140x40-Lochplatte-Gatenplaat-Connecteur métallique-Piastre forate-Placas perforadas 	2	140x40			
CI	Ceiling Insulation-Deckelsolation-Plafondisolatie-Isolation du plafond-Isolamento del soffitto-Aislamiento de techo 	2	1990x995			
	Lower Bench-Untere Bank-Onderbank-Banc inférieur-Banco inferiore-Banco inferior 	1	360x2000			
	Nail 1.8x40-Nagel-Spijker-Clou-Chiodo-Clavo 	270	1.8x40			
	Sauna door kit-Sauna tür satz-Sauna deur set-Kit porte sauna-Kit sauna porta-Kit para sauna puerta 	1				
	Sauna ventilation kit-Außengitter-Schoepenrooster-Panneau de ventilation-Griglia di ventilazione-Rejilla de ventilacion 	1				
S4x50	Screw 4x50-Schraube-Schroef-Vis-Vite-Tornillo 	25	4x50			
S5x70	Screw 5x70-Schraube-Schroef-Vis-Vite-Tornillo 	30	5x70			
S6x120	Screw 6x120-Schraube-Schroef-Vis-Vite-Tornillo 	15	6x120			
	Upper bench-Obere Bank-Bovenbank-Banc supérieur-Banco superiore-Banco superior 	1	600x2000			
	<p>WINDOW 445x1850      DOOR 800x1900      WINDOW 445x1850</p> <p>W08 H 445x1850-40 ISO +SD08 F 800x1900-40 R ISO + W08 H 445x1850-40 ISO</p> <p>TEMPERED                      TEMPERED                      TEMPERED</p> 	1+1+1				
	Window trim board 	4	18x45	1870		
	Window trim board 	4	18x70	392		
	Window trim board 	4	18x70	1845		
	Window trim board 	2	18x95	1830		
S4x60	Screw 4x60-Schraube-Schroef-Vis-Vite-Tornillo 	60	4x60			
Kood	Sauna Lizzy 40 XXS	Materjal	File	Sauna Lizzy 40 XXS.dwg	Leht	2/2

H = 1.600 m  
 TOTAL: 4.01 m<sup>2</sup>

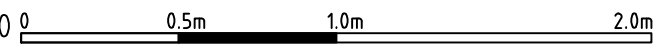
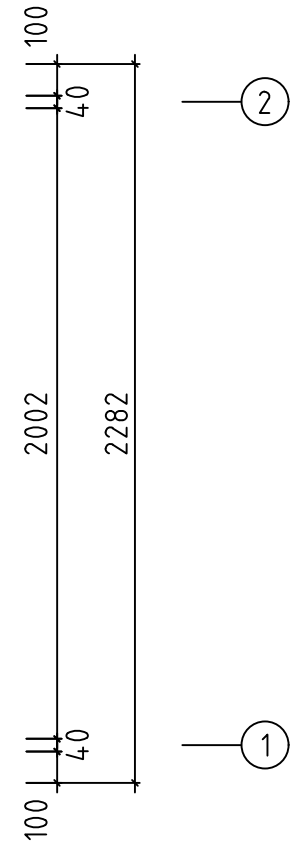
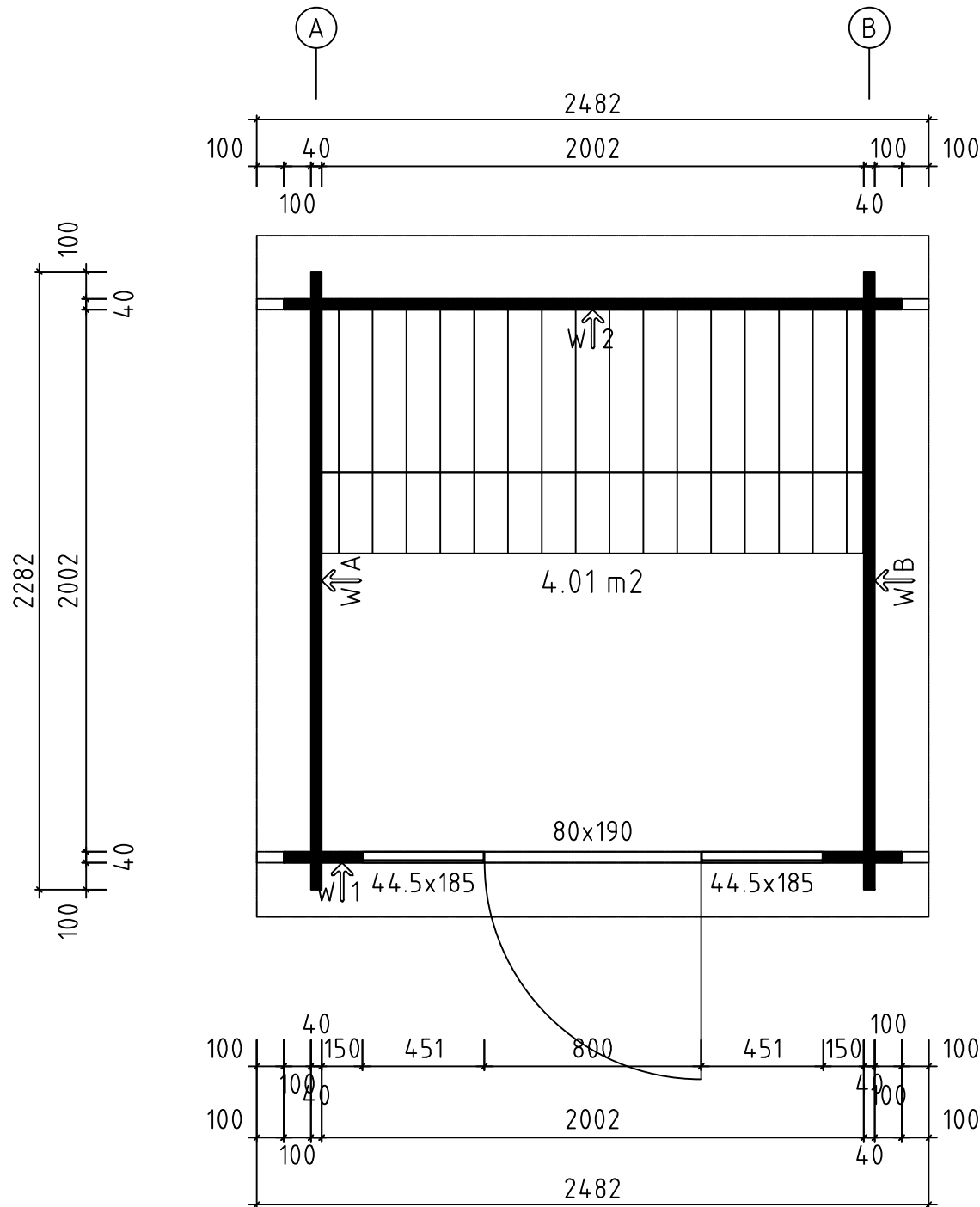

Model	Sauna Lizzy 40 XXS		Drawing	PLAN	Page
	Alpholz		Drawn by	Material	40x114
			Date	06.03.2024	Scale
				File	Sauna Lizzy 40 XXS.dwg

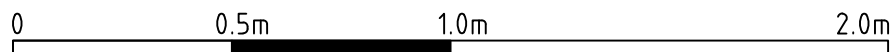
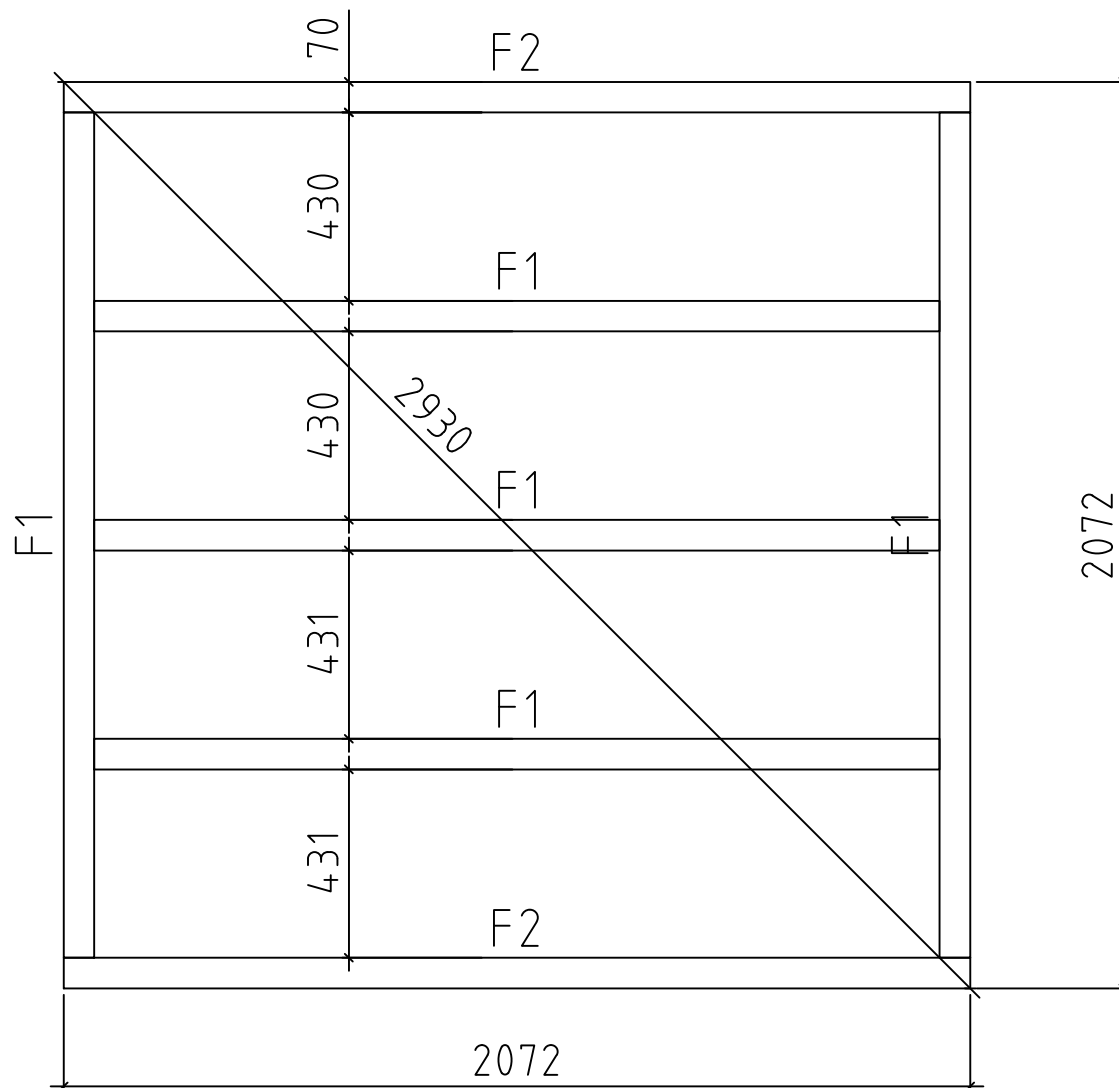

Model	Sauna Lizzy 40 XXS	Drawing	FOUNDATION	Page	
	Drawn by	Material	40x114	Scale	1:20
	Date	06.03.2024	File	Sauna Lizzy 40 XXS.dwg	



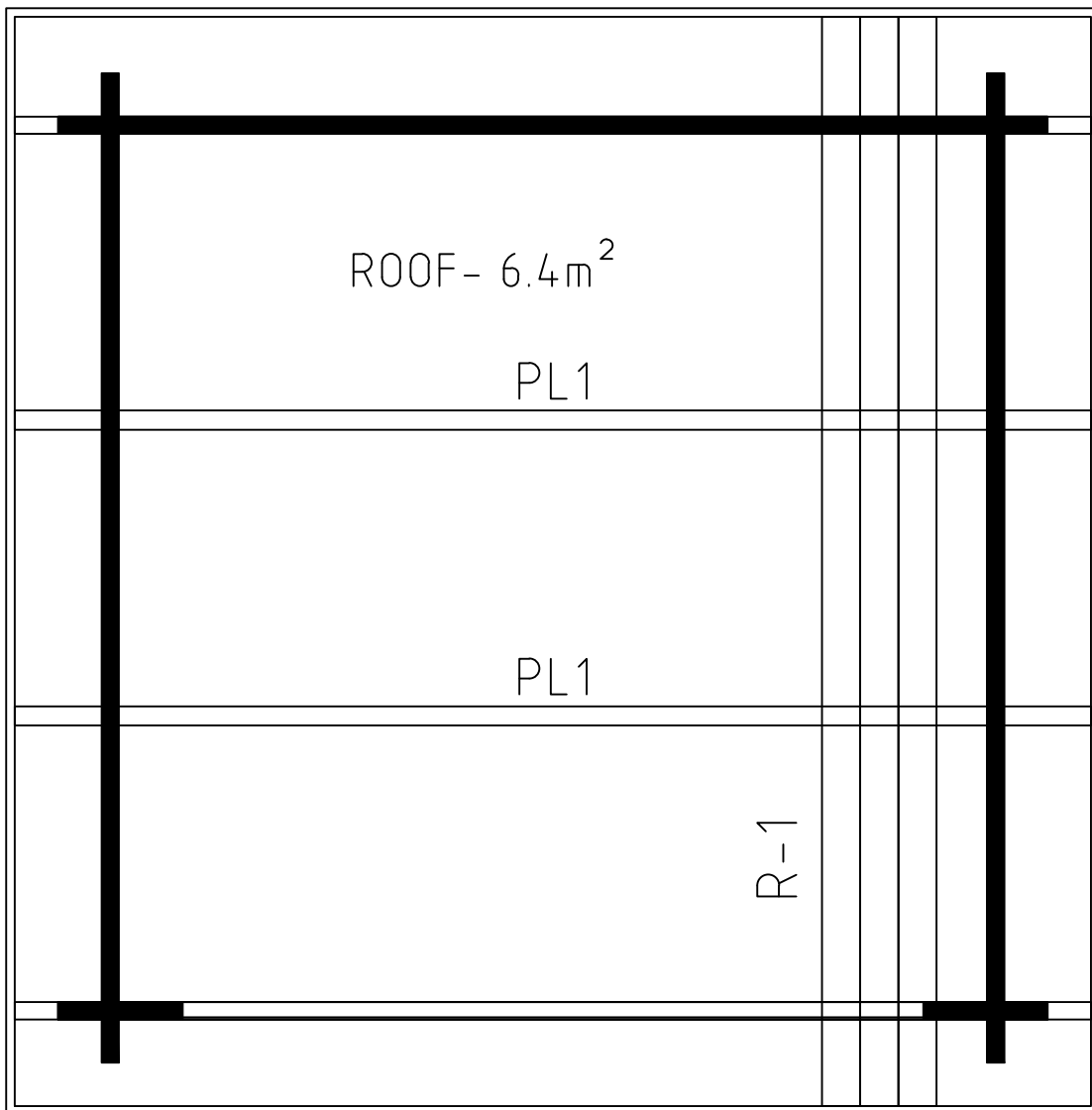

0 0.5m 1.0m 2.0m

Model	Sauna Lizzy 40 XXS	Drawing	CEILING & ROOF	Page
	Drawn by	Material	40x114	Scale
	Date	06.03.2024	File	Sauna Lizzy 40 XXS.dwg

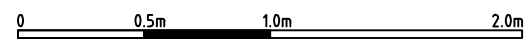
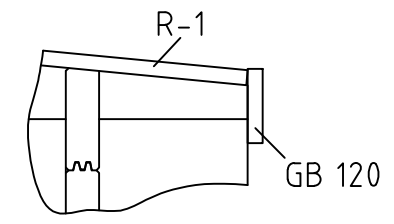
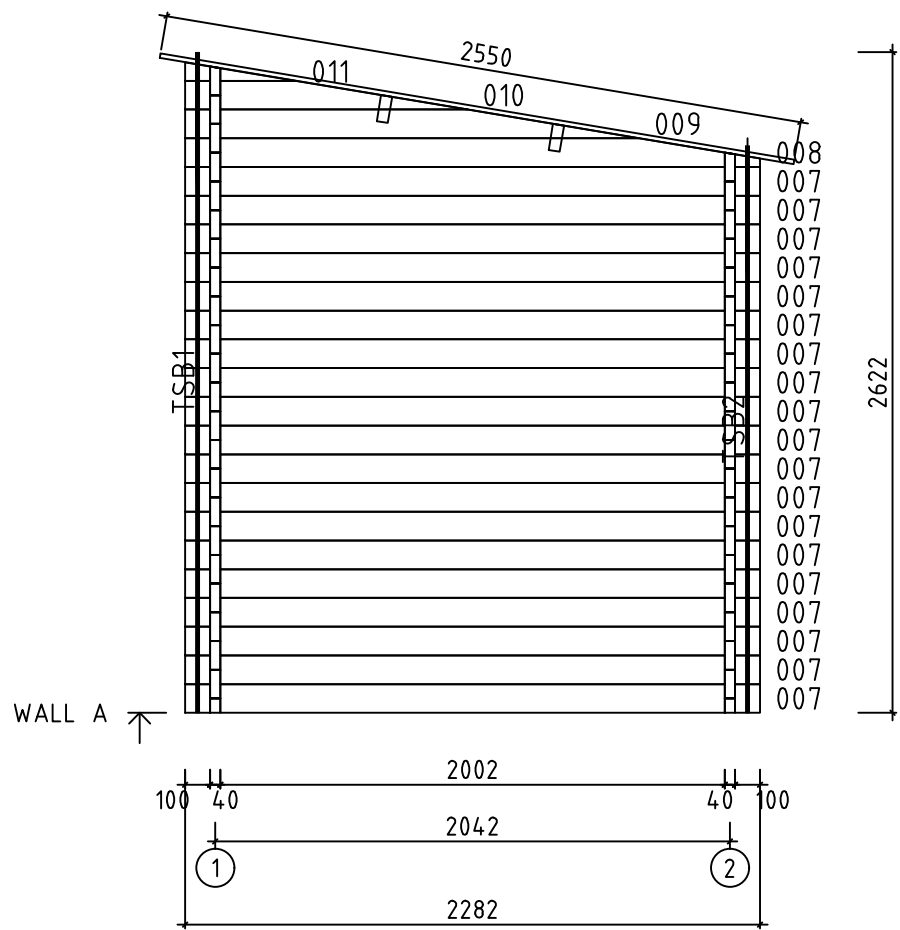
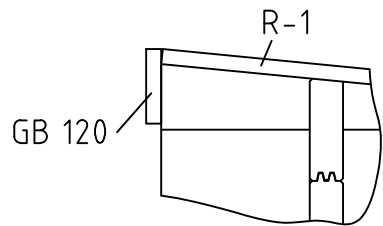

Model	Sauna Lizzy 40 XXS		Drawing	WALL A	Page	3
	Drawn by		Material	4x11.4	Scale	1:20
	Date	06.03.2024	File	Sauna Lizzy 40 XXS.dwg		

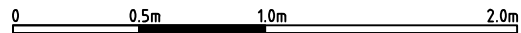
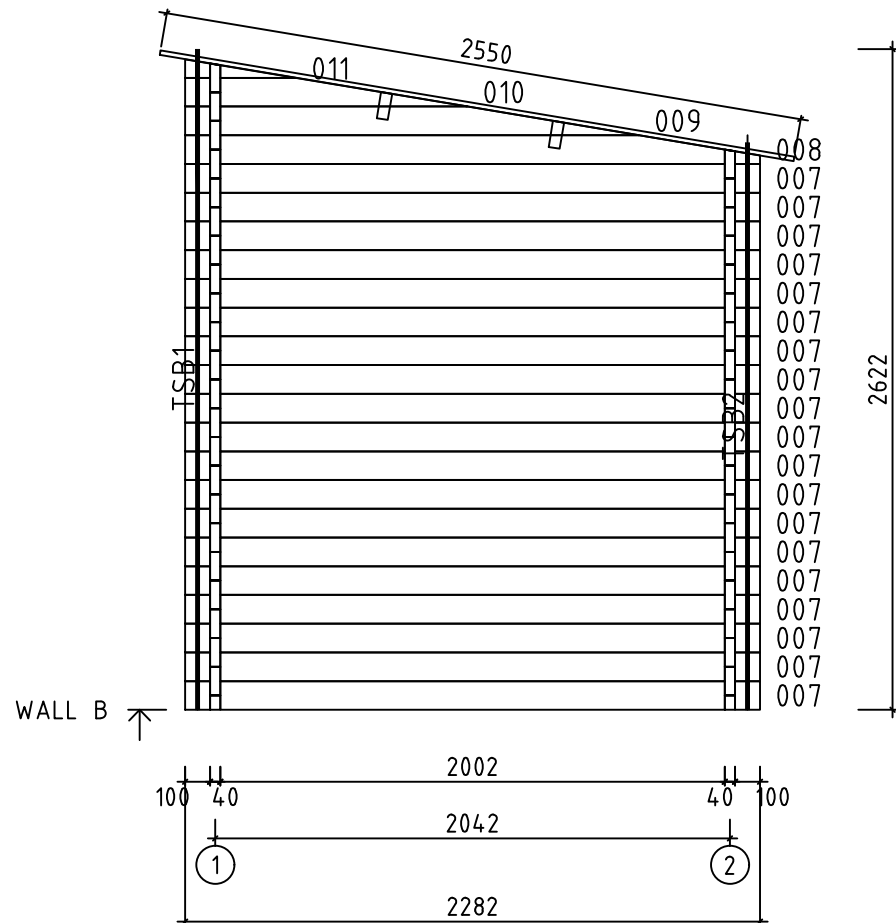

Model	Sauna Lizzy 40 XXS	Drawing	WALL B	Page	4	
		Drawn by	Material	4x11.4	Scale	1:20
		Date	06.03.2024	File	Sauna Lizzy 40 XXS.dwg	

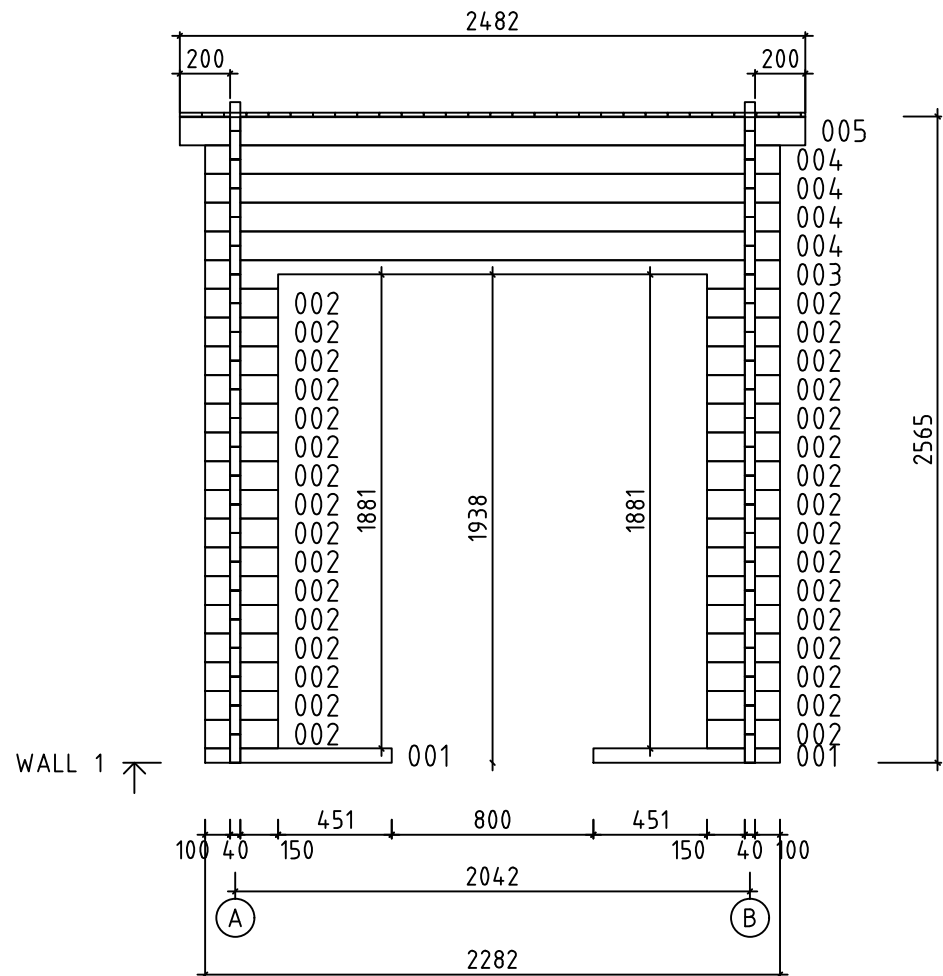
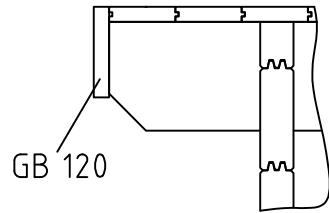

0 0.5m 1.0m 2.0m

Model	Sauna Lizzy 40 XXS	Drawing	WALL 1	Page	5
	Drawn by	Material	4x11.4	Scale	1:20
	Date	06.03.2024	File	Sauna Lizzy 40 XXS.dwg	

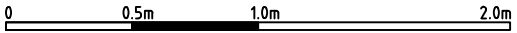
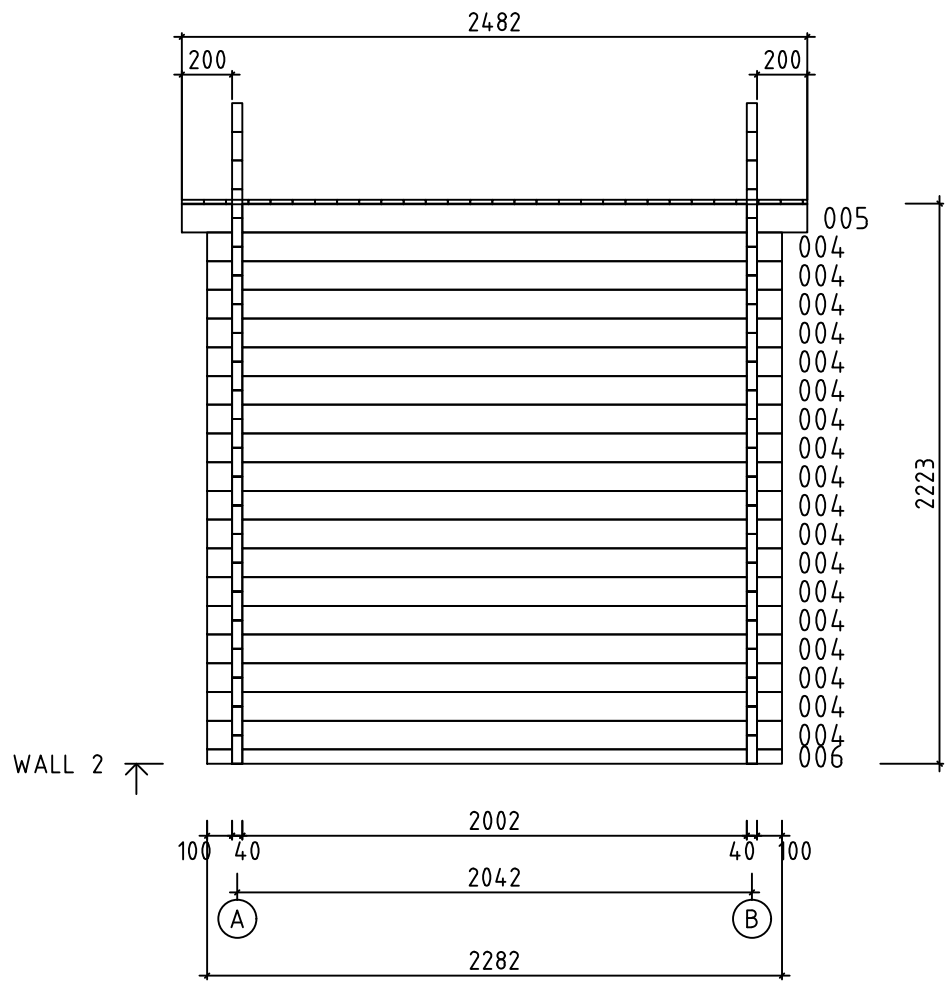

Model	Sauna Lizzy 40 XXS	Drawing	WALL 2	Page	6	
		Drawn by	Material	4x11.4	Scale	1:20
		Date	06.03.2024	File	Sauna Lizzy 40 XXS.dwg	