

Alpho^h2

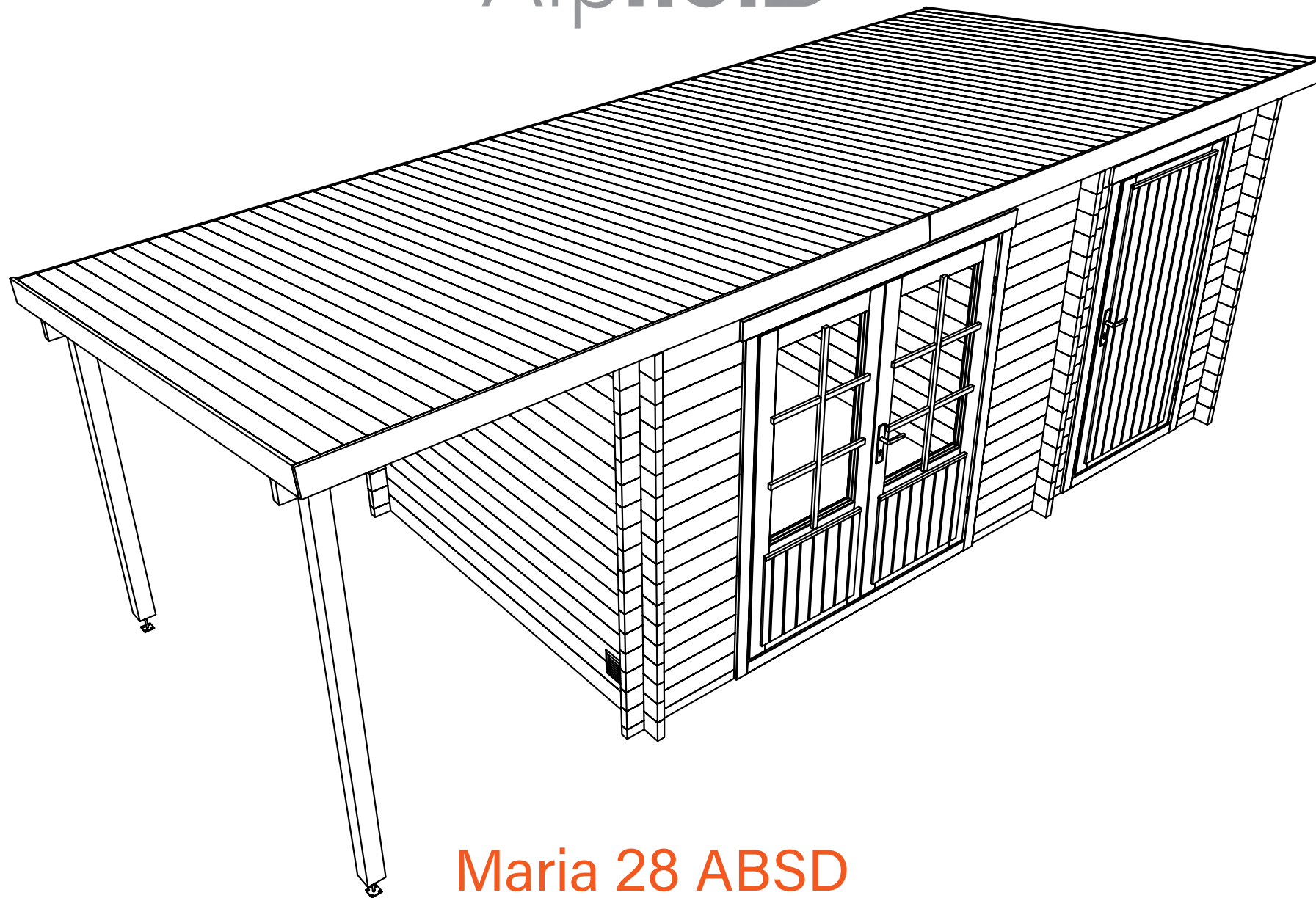

Maria 28 ABSD

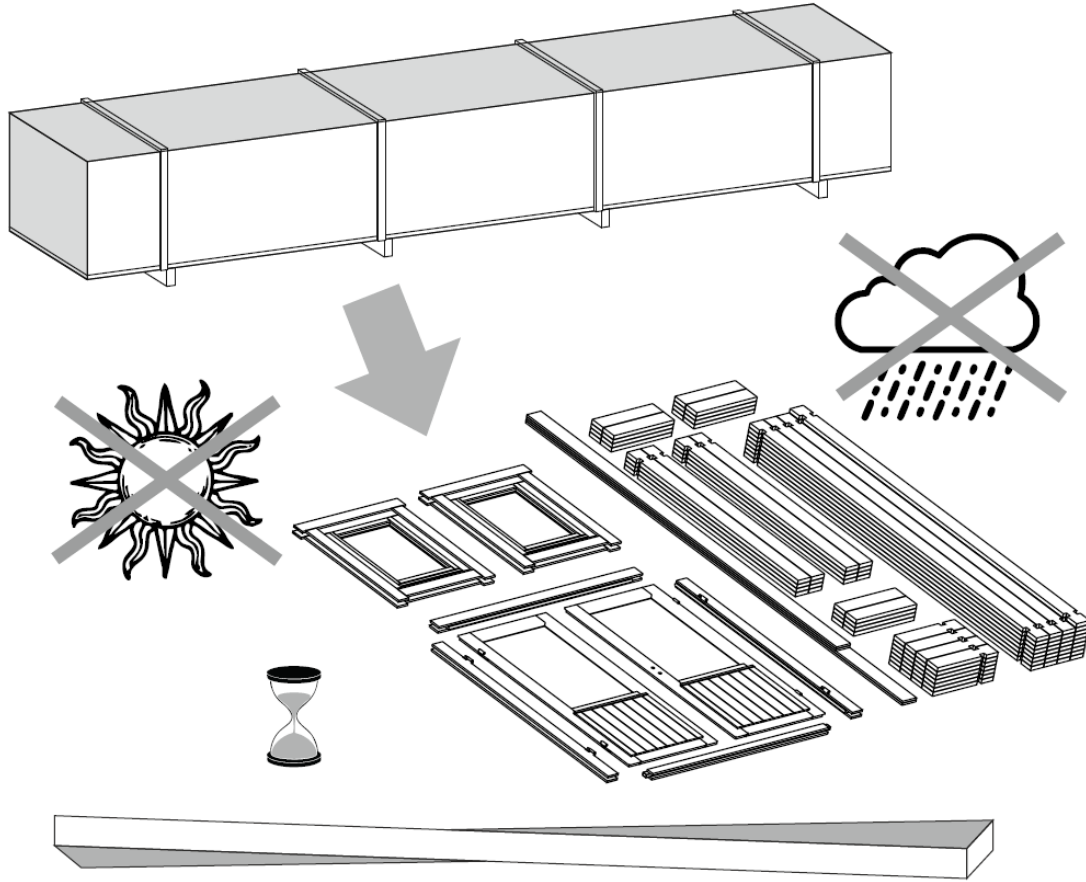

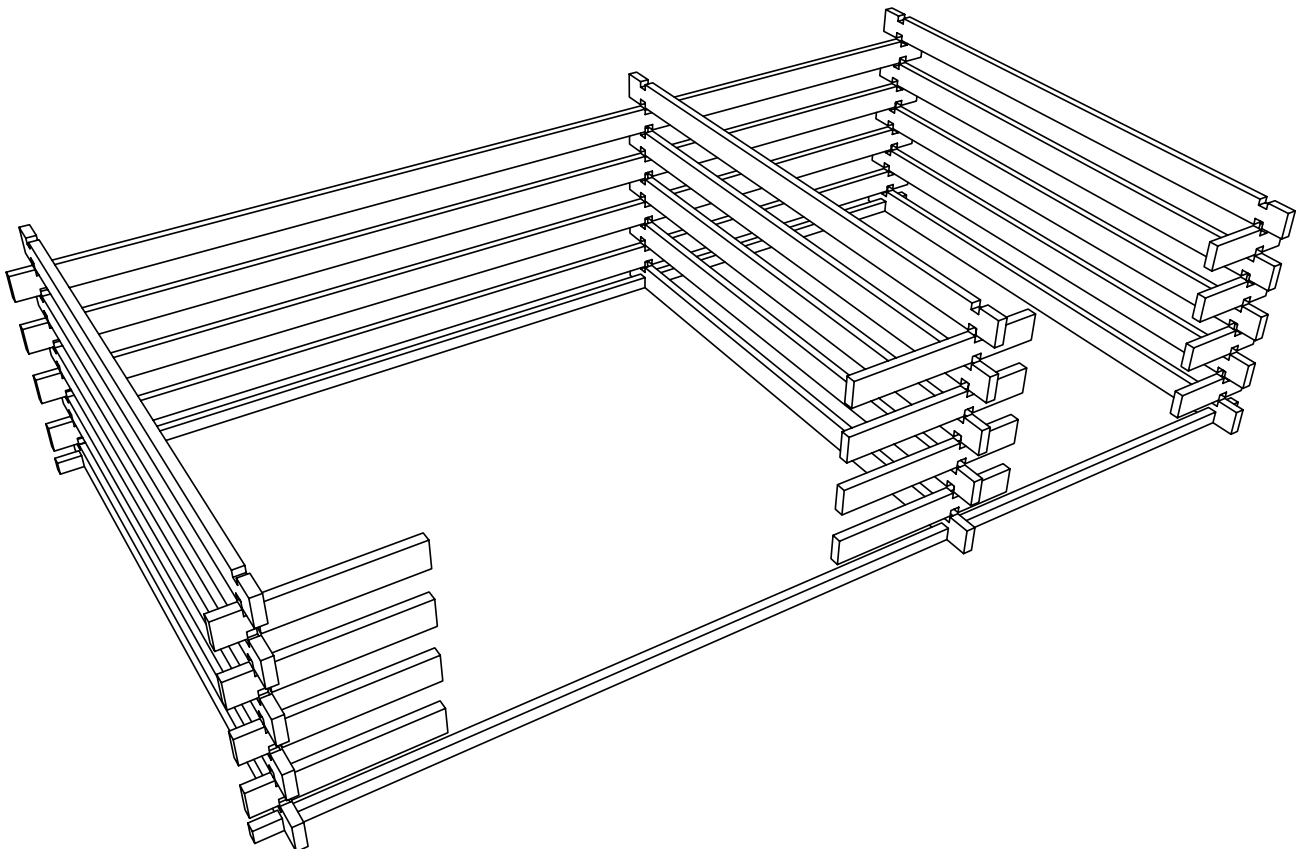
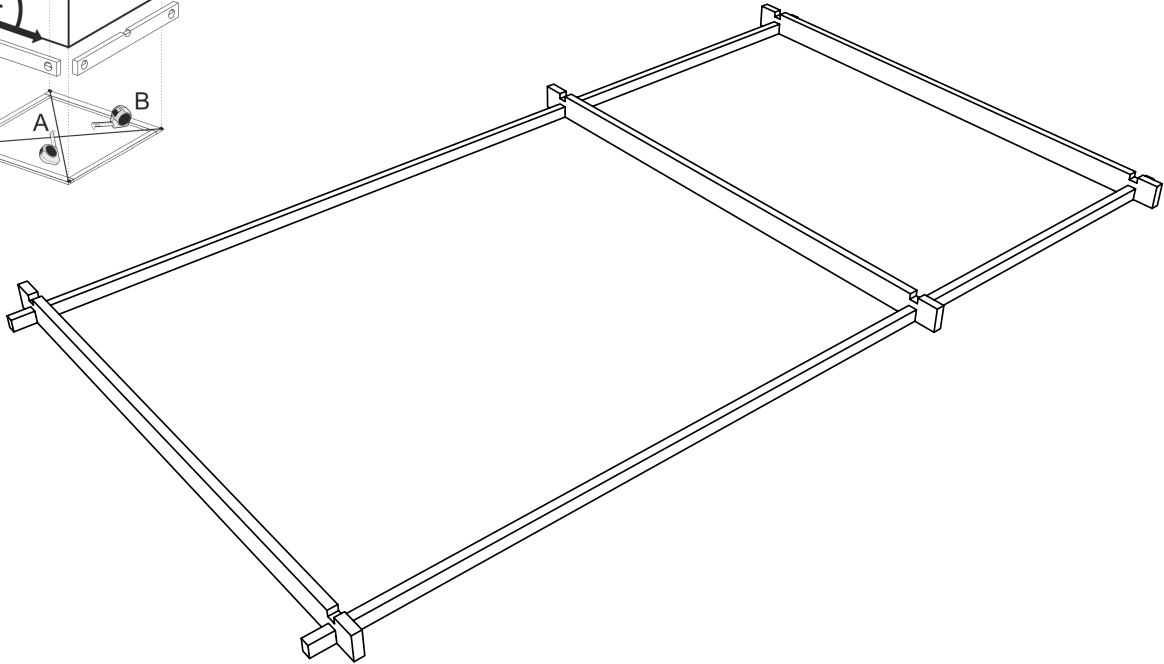
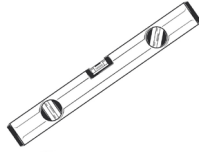
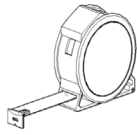
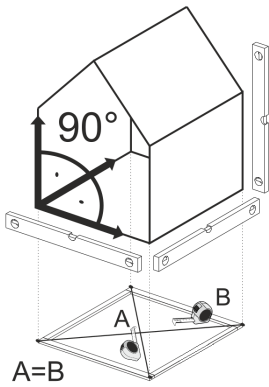

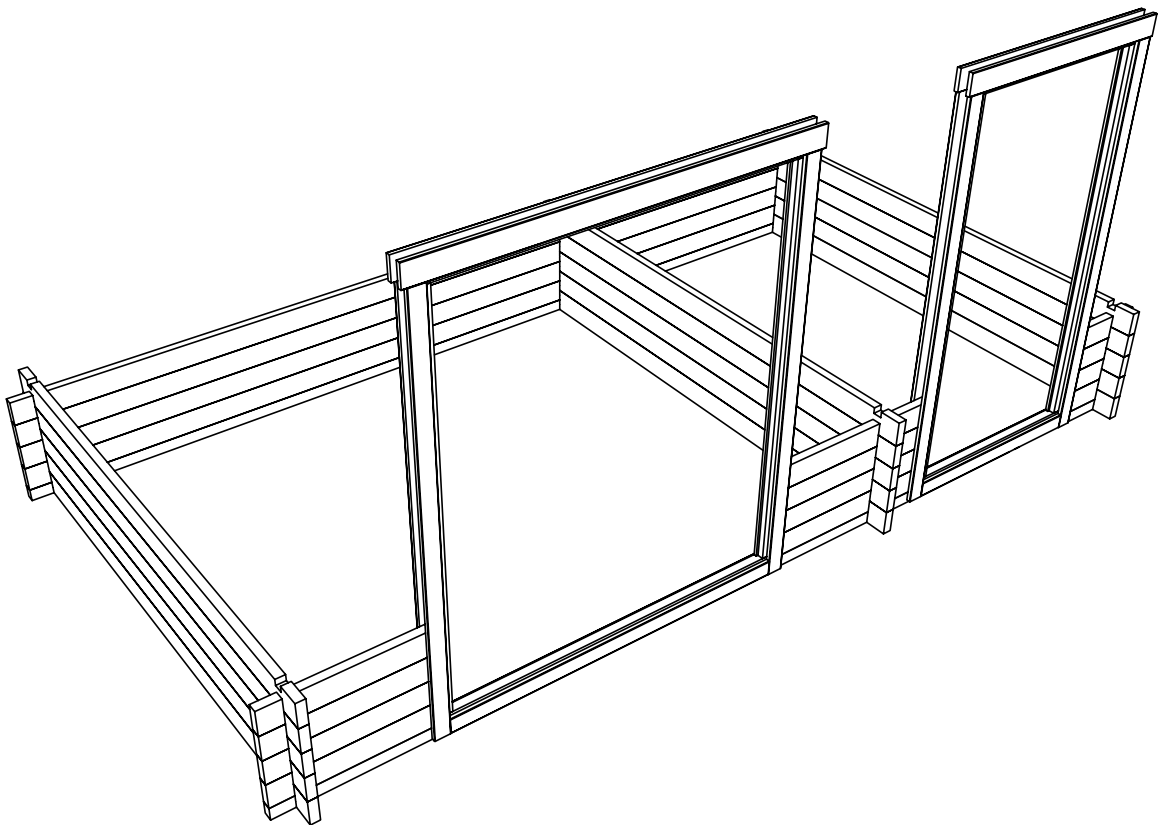
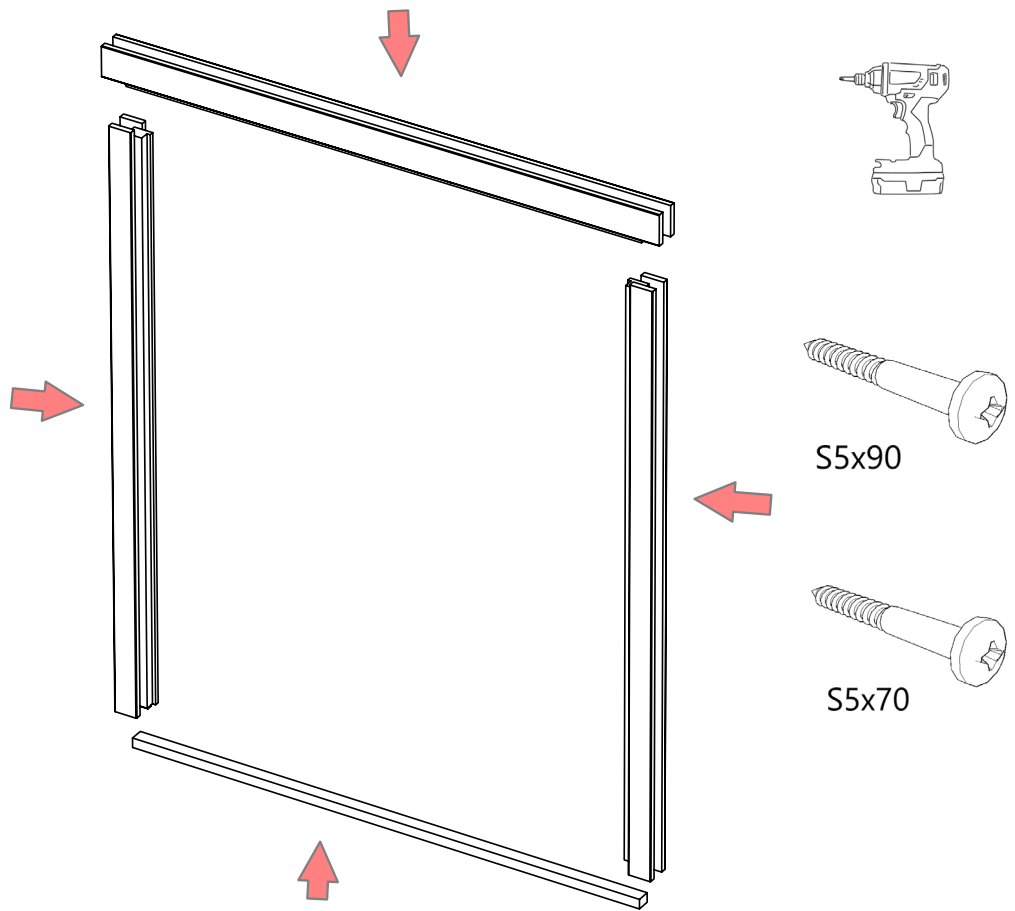

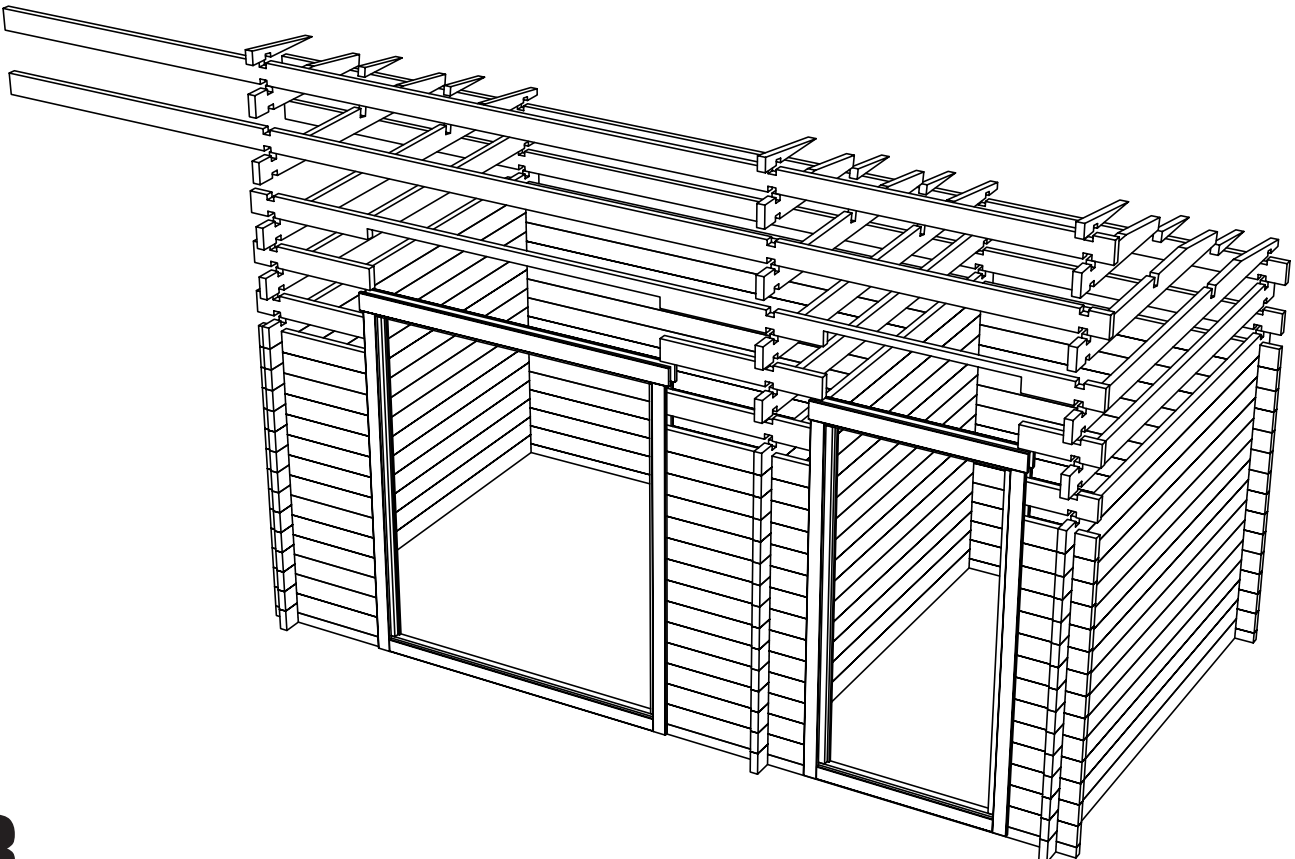
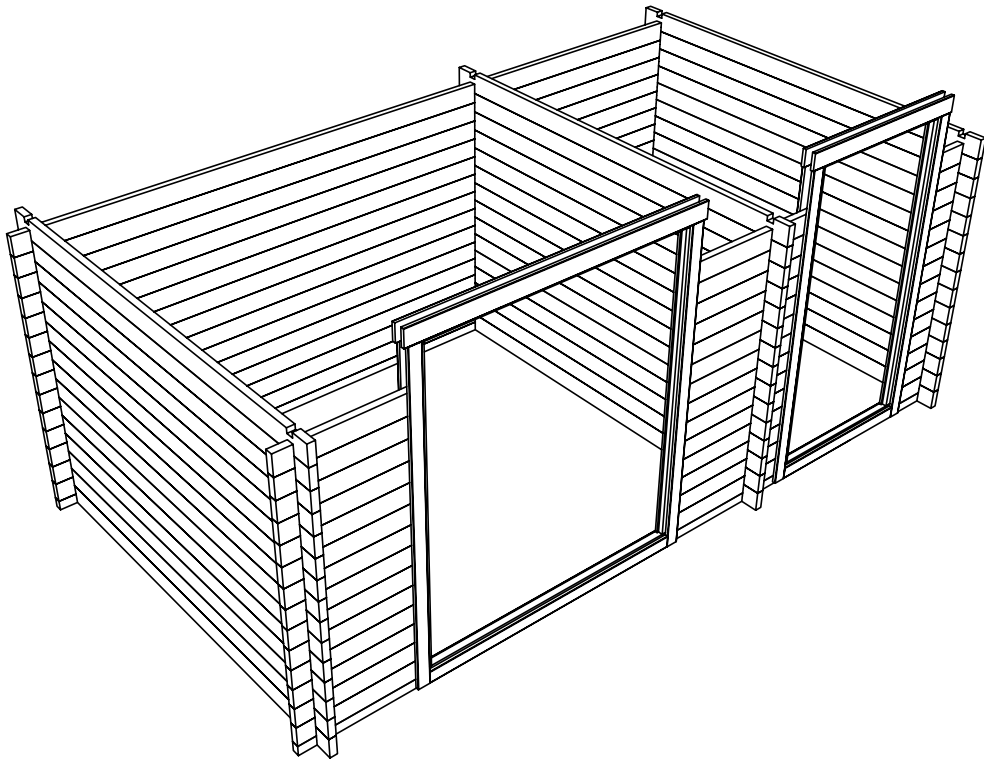

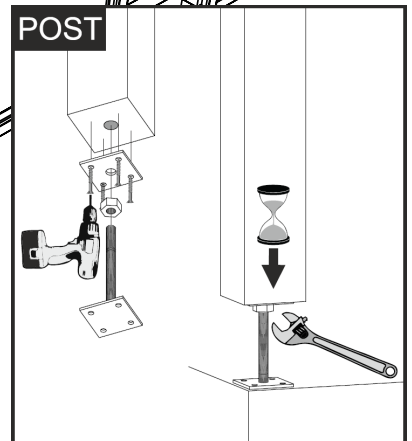
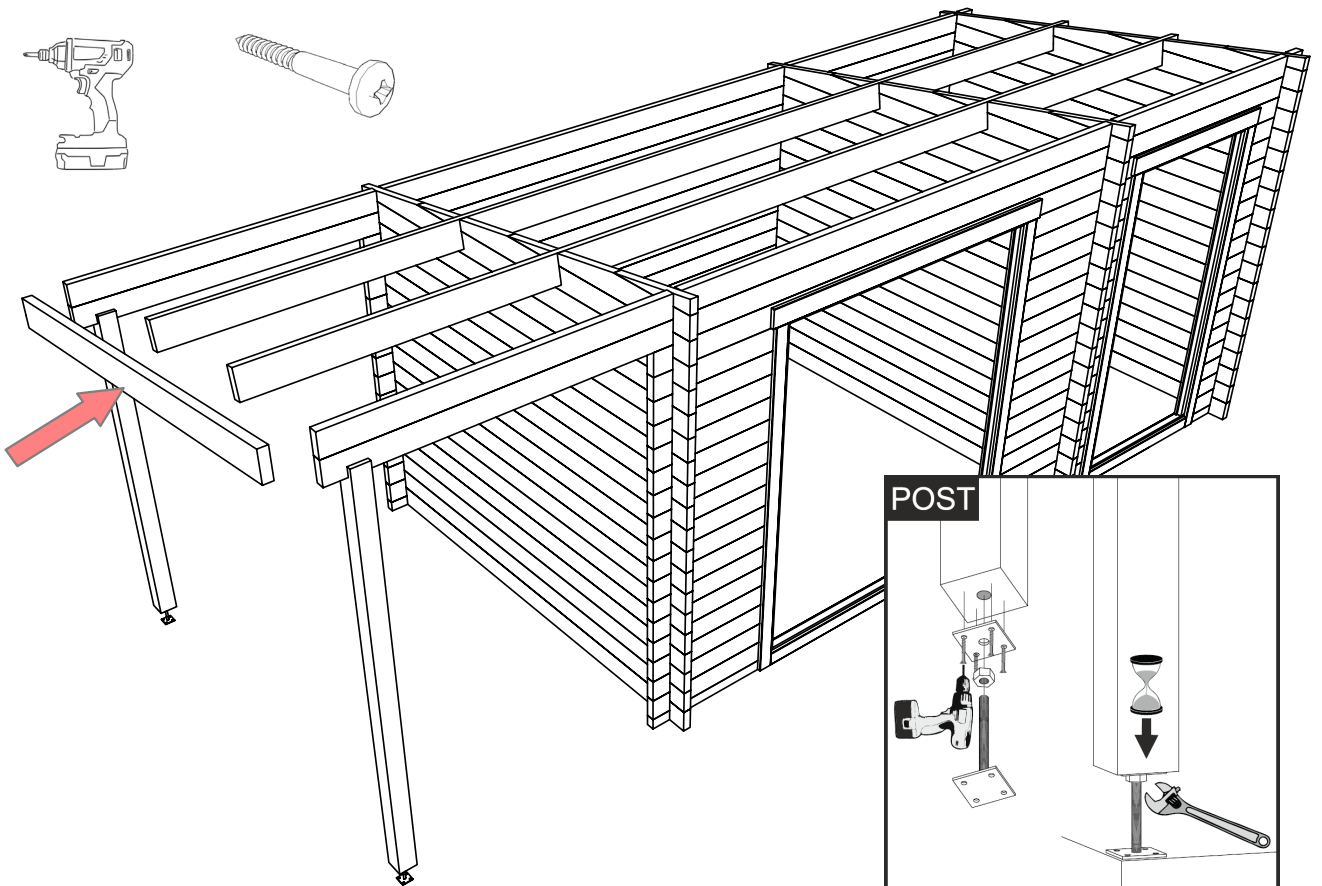
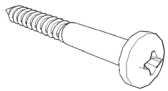
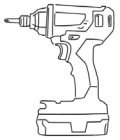
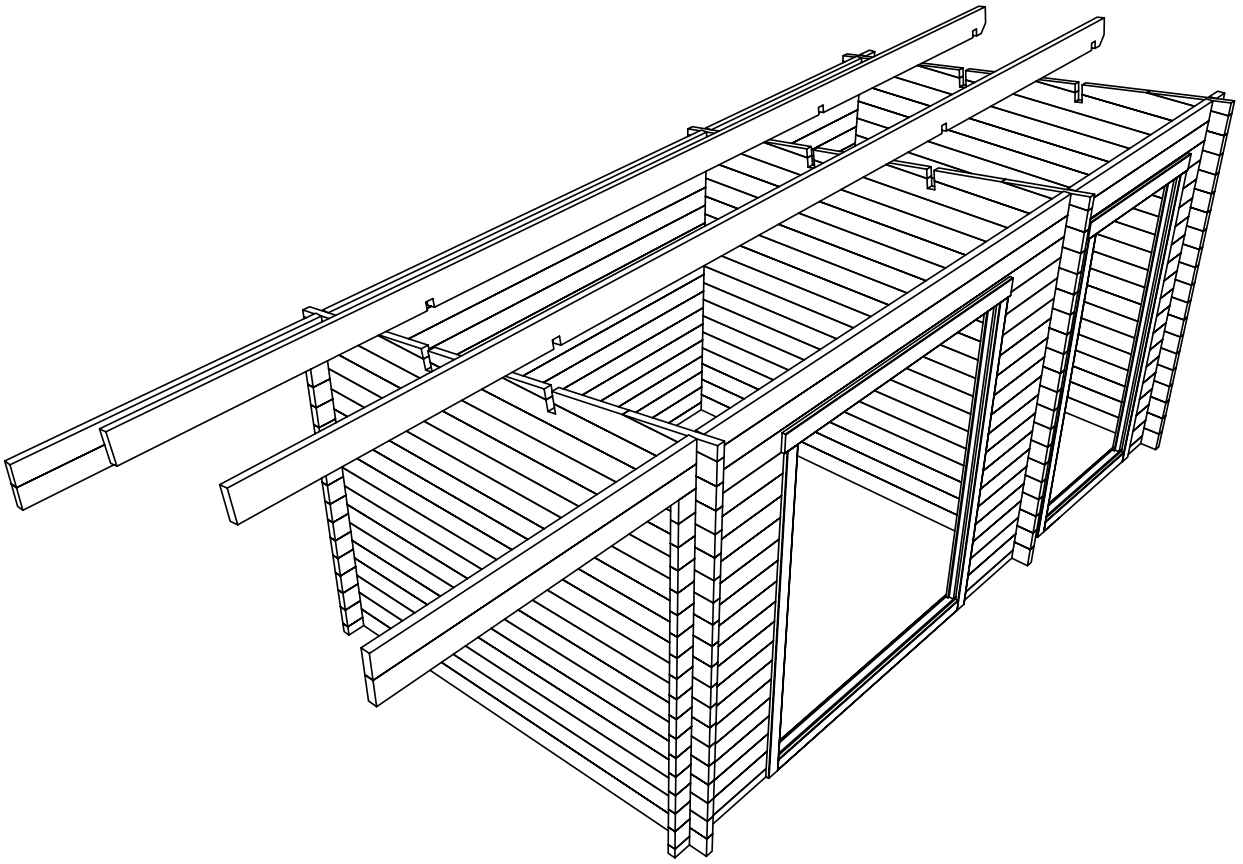

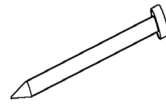
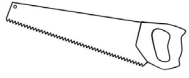

N1,8x40

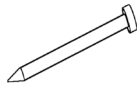
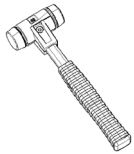
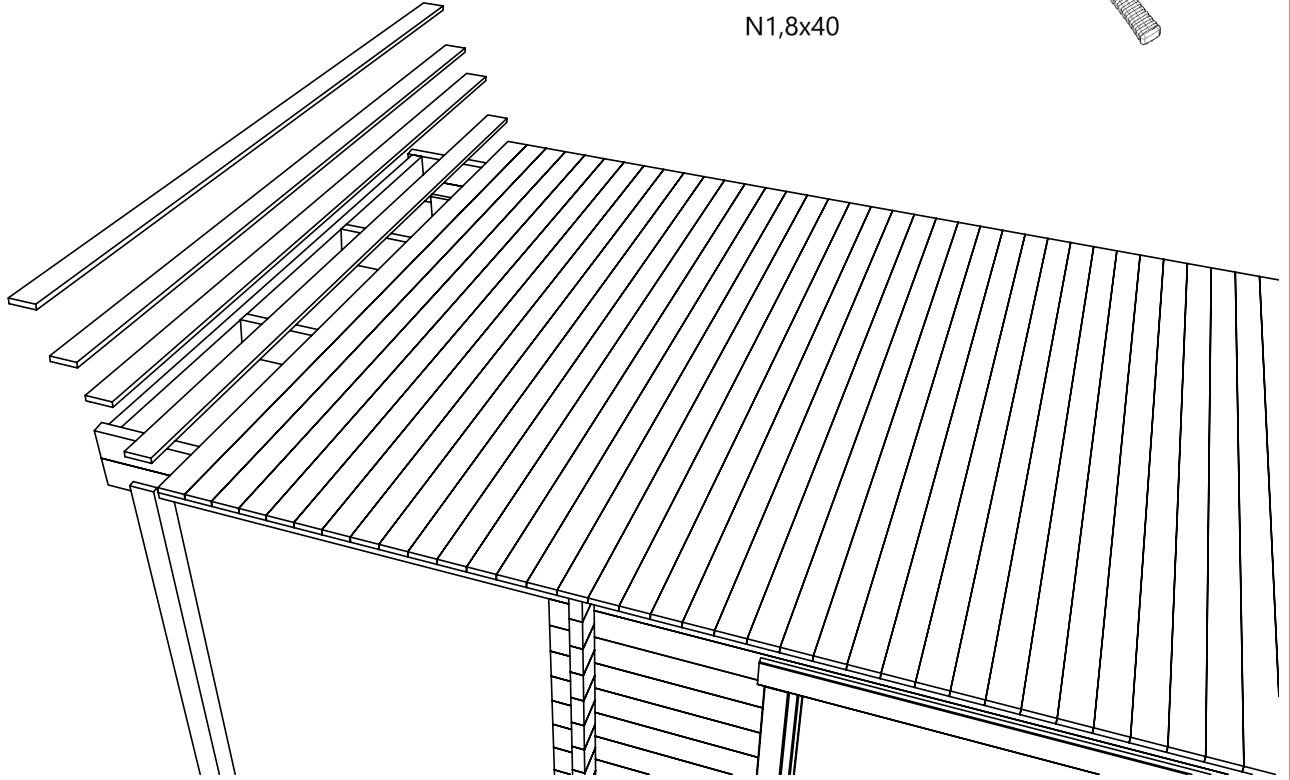
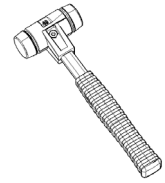

N1,8x40

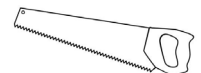
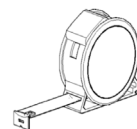
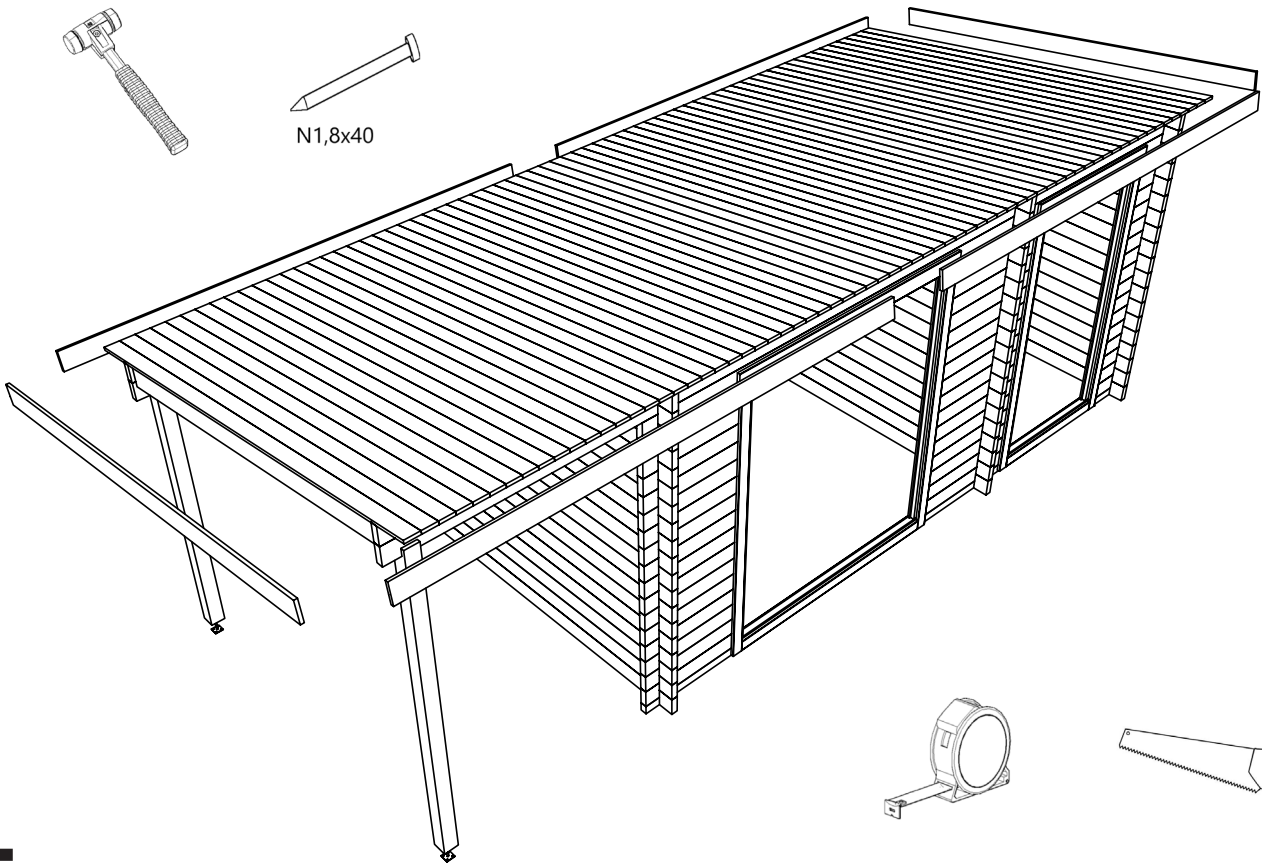

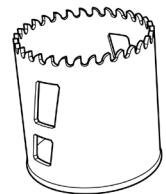
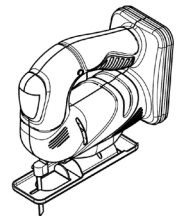
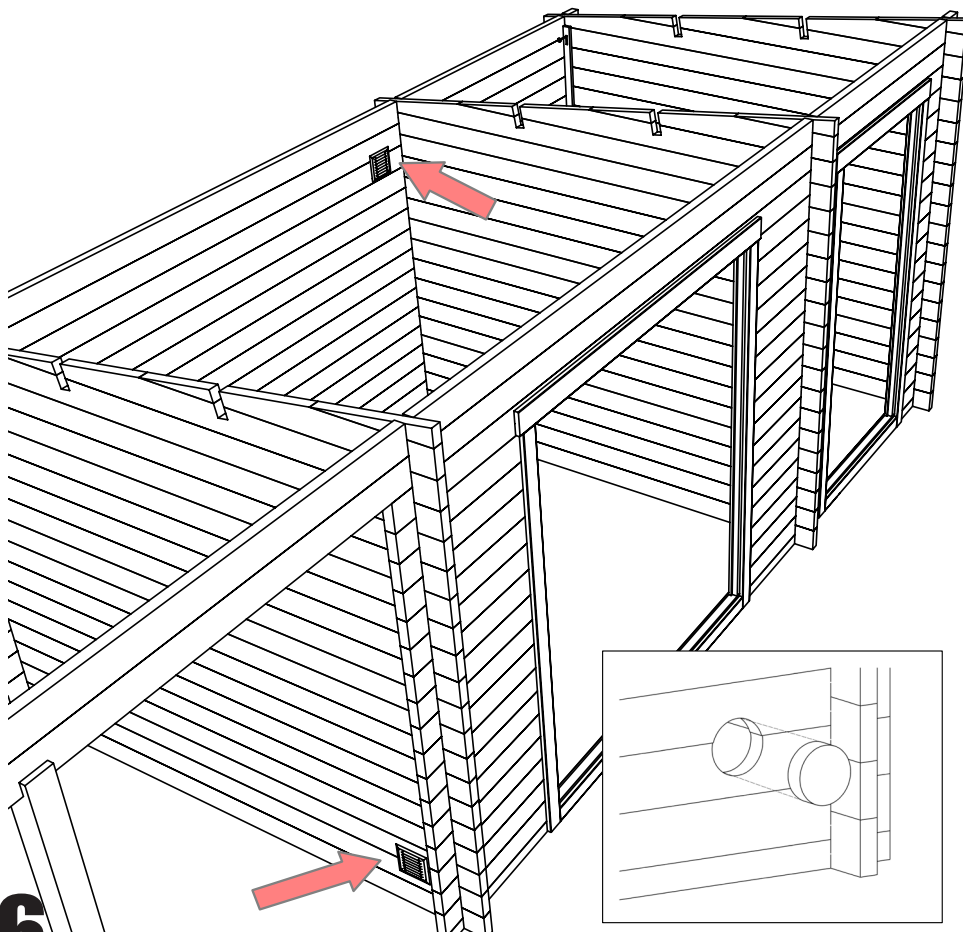
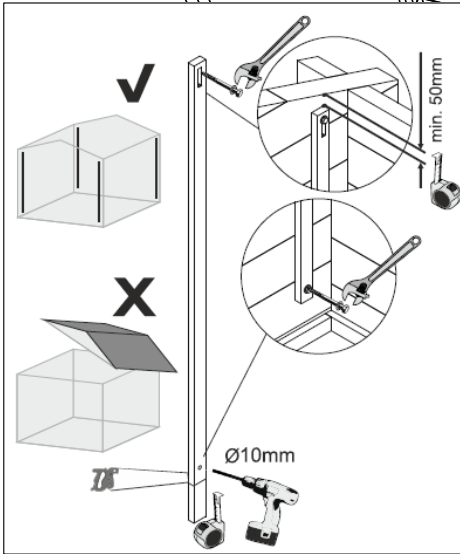
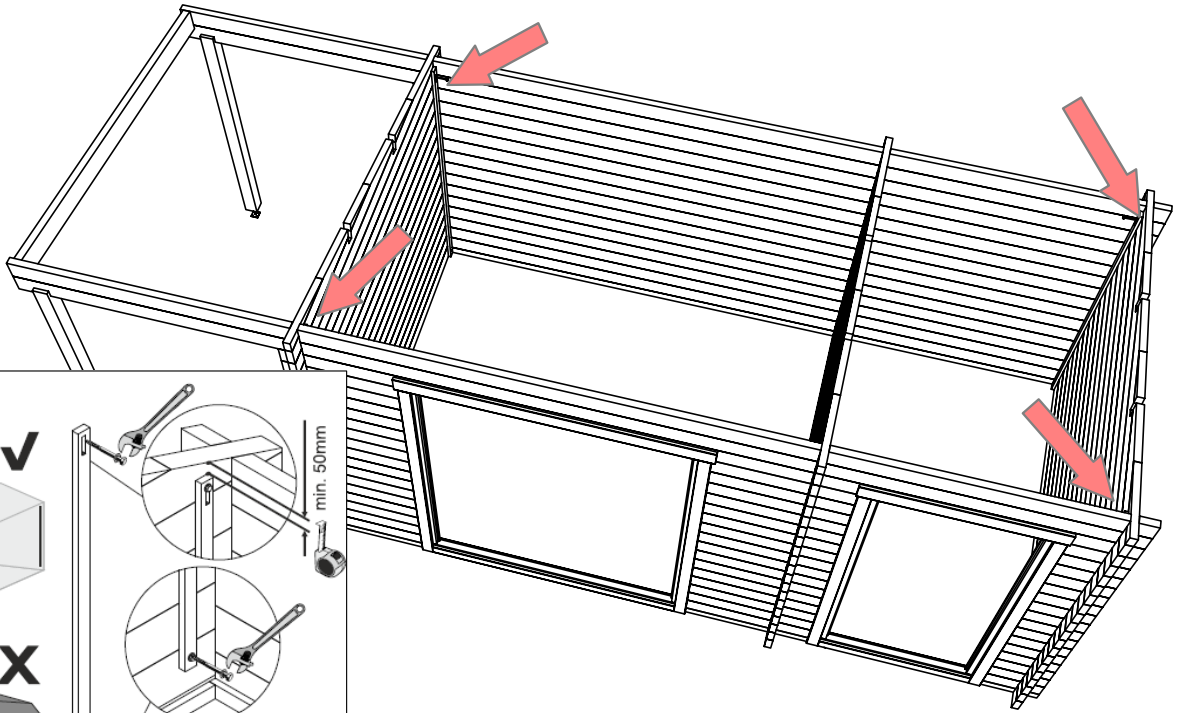

Ø ca 130mm

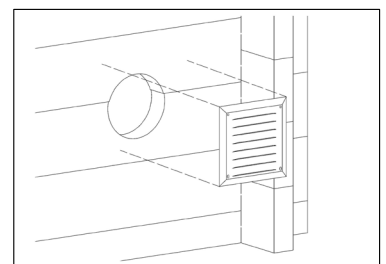
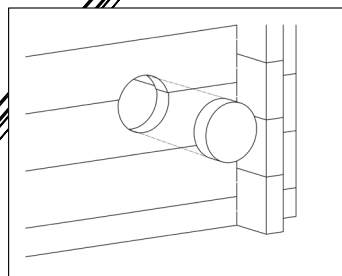



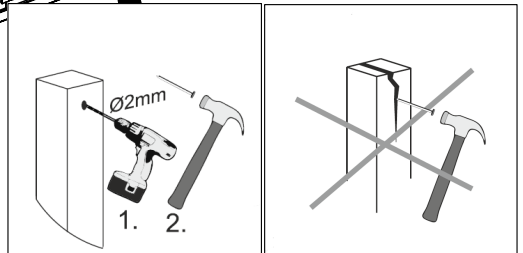
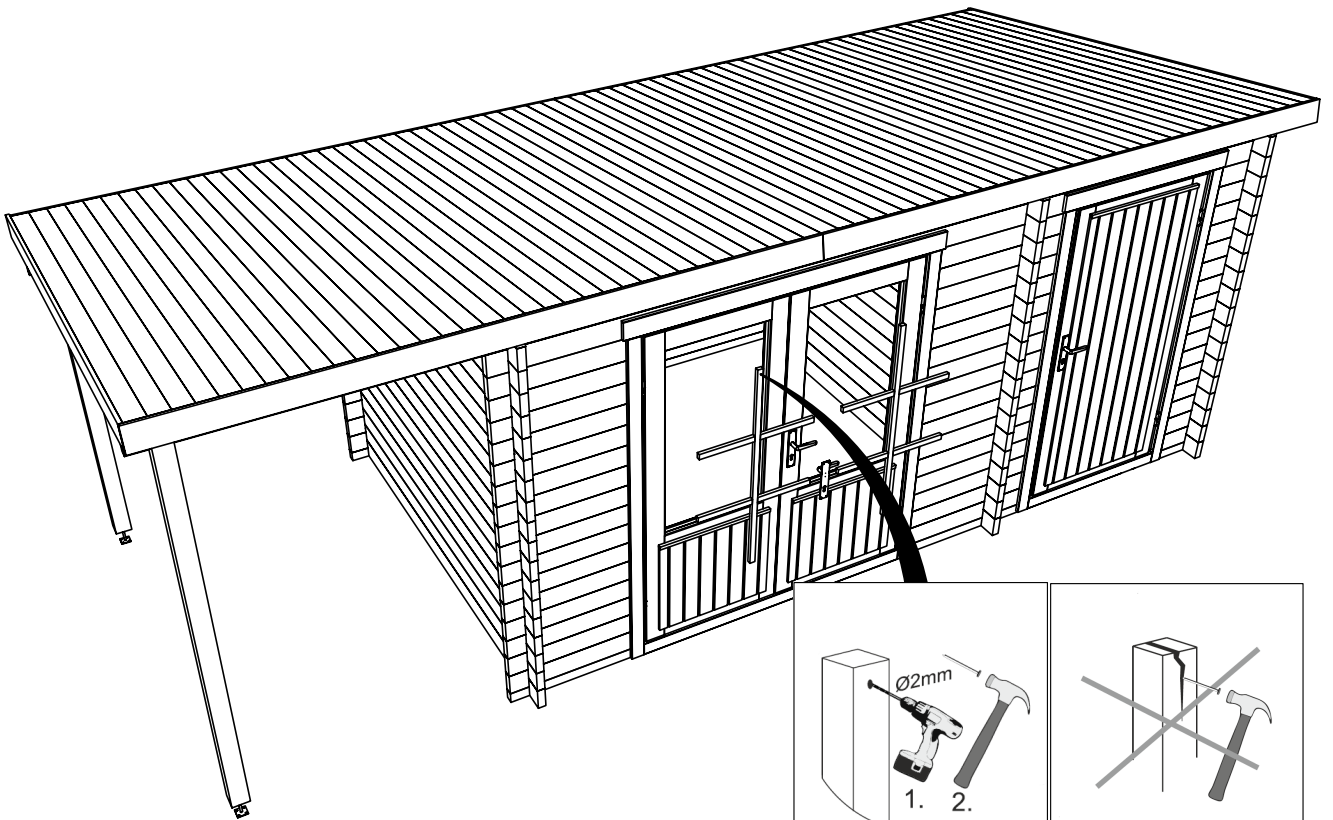
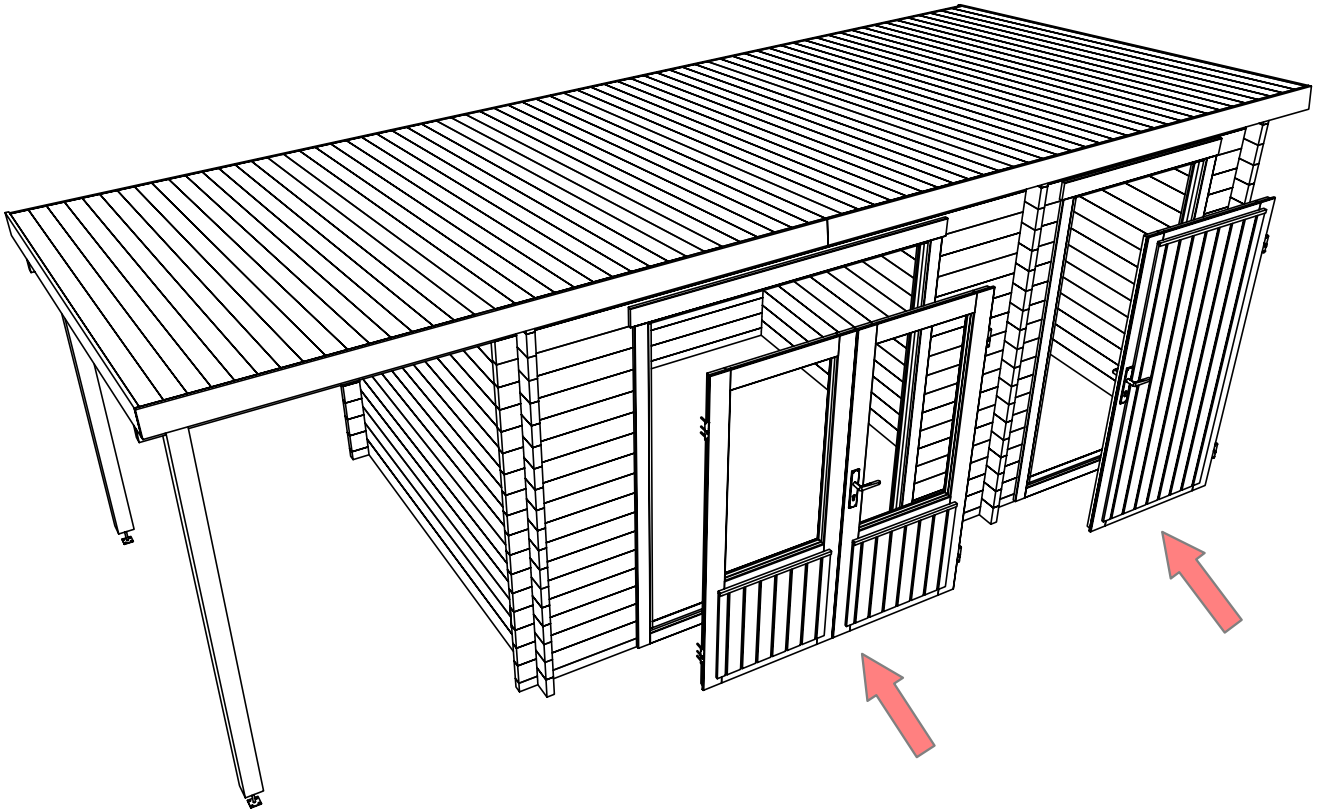

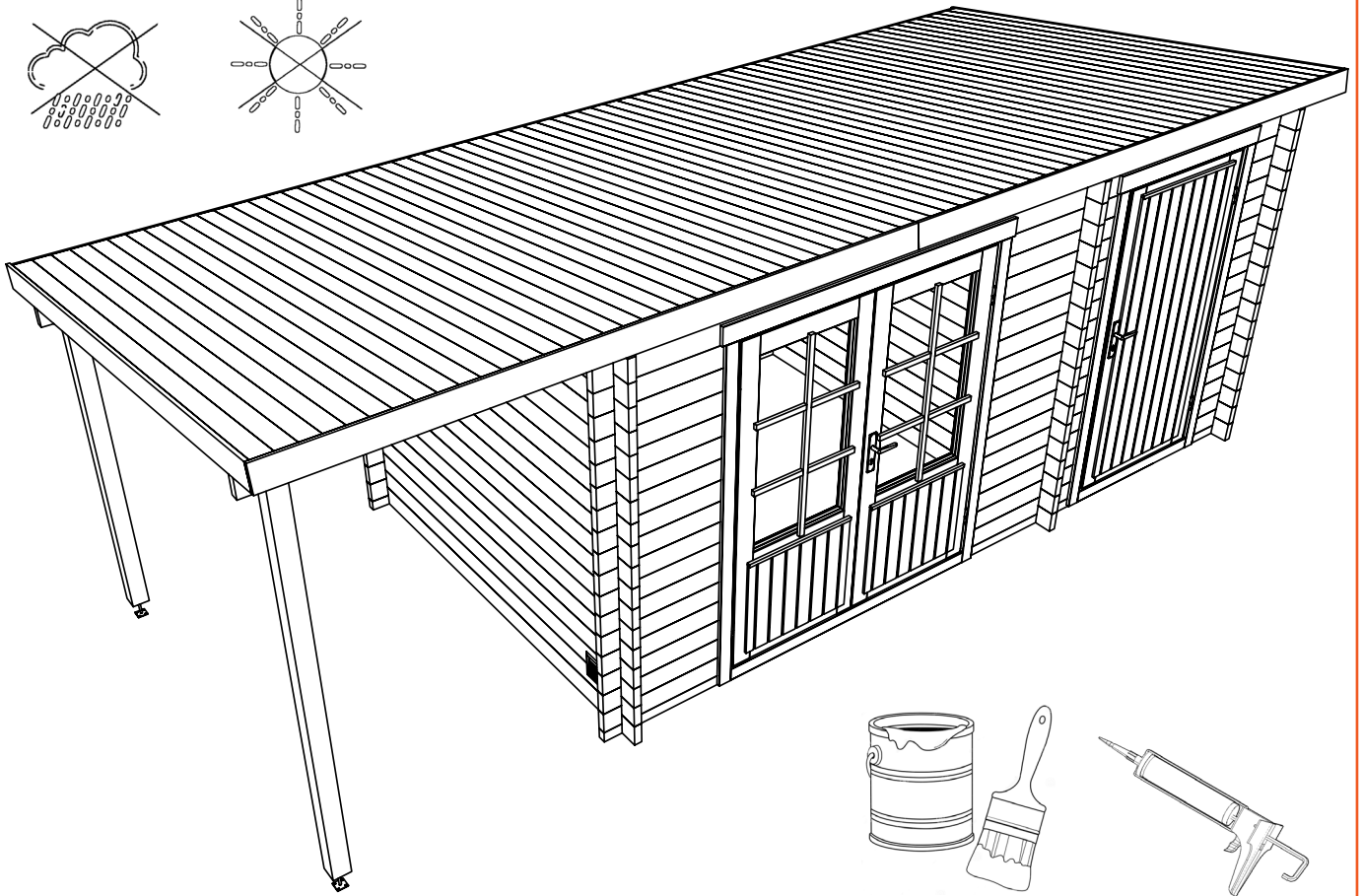
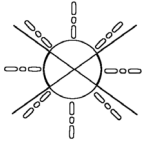
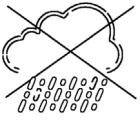

6



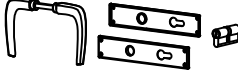

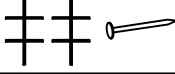

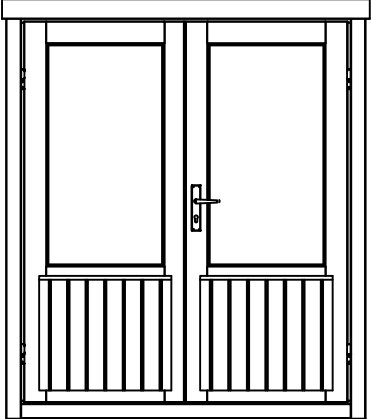
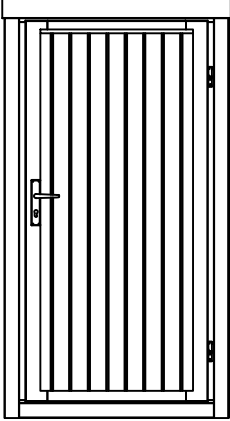
Pos	Specification-Spezifikation-Specificatie-Nomenclature-Elementi-Especificacion Maria 28 ABSD	Qty	Profile (mm)	Lenght (mm)
001		2	28x57	4500
002		16	28x114	690
003		16	28x114	845
004		16	28x114	385
005		1	28x114	4500
006		2	28x114	5980
007		1	28x114	5980
008		14	28x114	4500
009		1	28x114	5980
010		48	28x114	2500
EXTRA		1	28x114	4500
WB-1		1		
WC-1		1		
WD-1		1		
RT1	RAFTER-SPARREN-DAKSPAR-CHEVRON-TRAVE-CABRIO 	1	44x144	2291
PL1	PURLIN-DAKBALK-DACHPFETTE-PANNE-ARCARECCIO-CORREA 1496 2744 51 	2	44x144	4347
PL2	PURLIN-DAKBALK-DACHPFETTE-PANNE-ARCARECCIO-CORREA 51 1472 100 	2	44x144	1679
R-1	Roof board-Dachbrett-Dakplank-Volige-Tavola tetto-Tabla de tejado 	68+1 53+1	88x18 114x18	2750
	-POST 8.5x8.5 	1	85x85	1700
	-POST 8.5x8.5 	1	85x85	2040
GB-1	Gable board 120-Giebelblende-Gevelplank-Planche de rive-Tavola di bordo-Tabla de borde 	2	18x120	2790
GB-2	Gable board 120-Giebelblende-Gevelplank-Planche de rive-Tavola di bordo-Tabla de borde 	4	18x120	3008
SS-1	Storm slat kit-Sturmleiste satz-Stormanker set-Kit de latte anti tempête-Kit listello di tempesta-Kit liston anti tormenta 	4	18x40	2000
Model	Maria 28 ABSD	Material	Page 1/2	

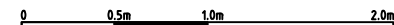
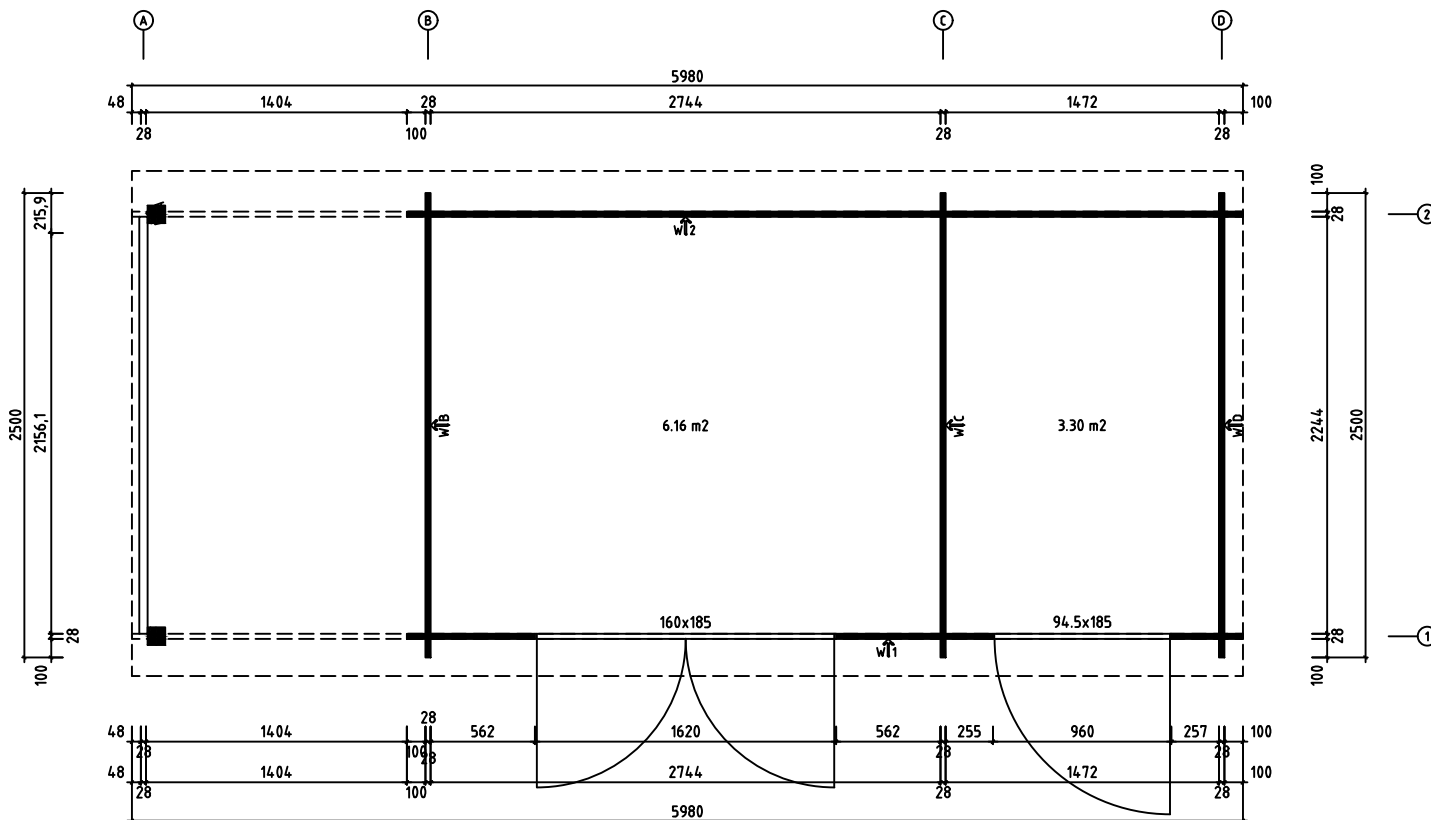
Pos	Specification-Spezifikation-Specificatie-Nomenclature-Elementi-Especificacion Maria 28 ABSD	Qty	Profile (mm)	Lenght (mm)
	Adjustable foot kit-Pfostenträger-Paalhouder-Pied de poteau-Portapilastrri-Base para poste 	2		
C8x80	Coach screw kit 8x80-Holzschraube-Houtdraadbout-Tirefond-Vite tirafondo-Tornillo entrenador 	8	8x80	
	Door kit-Tür satz-Deur set-Kit porte-Kit porta-Kit para puerta 	1		
	Double door kit-Doppeltür satz-Dubbele deur set-Kit double porte-Kit porta-Kit para puerta 	1		
	Nail 1.6x30-Nagel-Spijker-Clou-Chiodo-Clavo 	15	1.6x30	
	Nail 1.8x40-Nagel-Spijker-Clou-Chiodo-Clavo 	300	1.8x40	
	Ventilation panel kit-Außengitter-Schoepenrooster-Panneau de ventilation-Griglia di ventilazione-Rejilla de ventilacion 	1		
	DOOR 1600x1850 DD06-6 H 1600x1850-28 	1		
	DOOR 945x1850 SDL H 945x1850-28 R 	1		
Model	Maria 28 ABSD	Material	Page	2/2

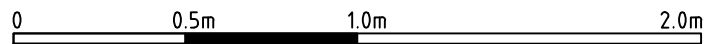
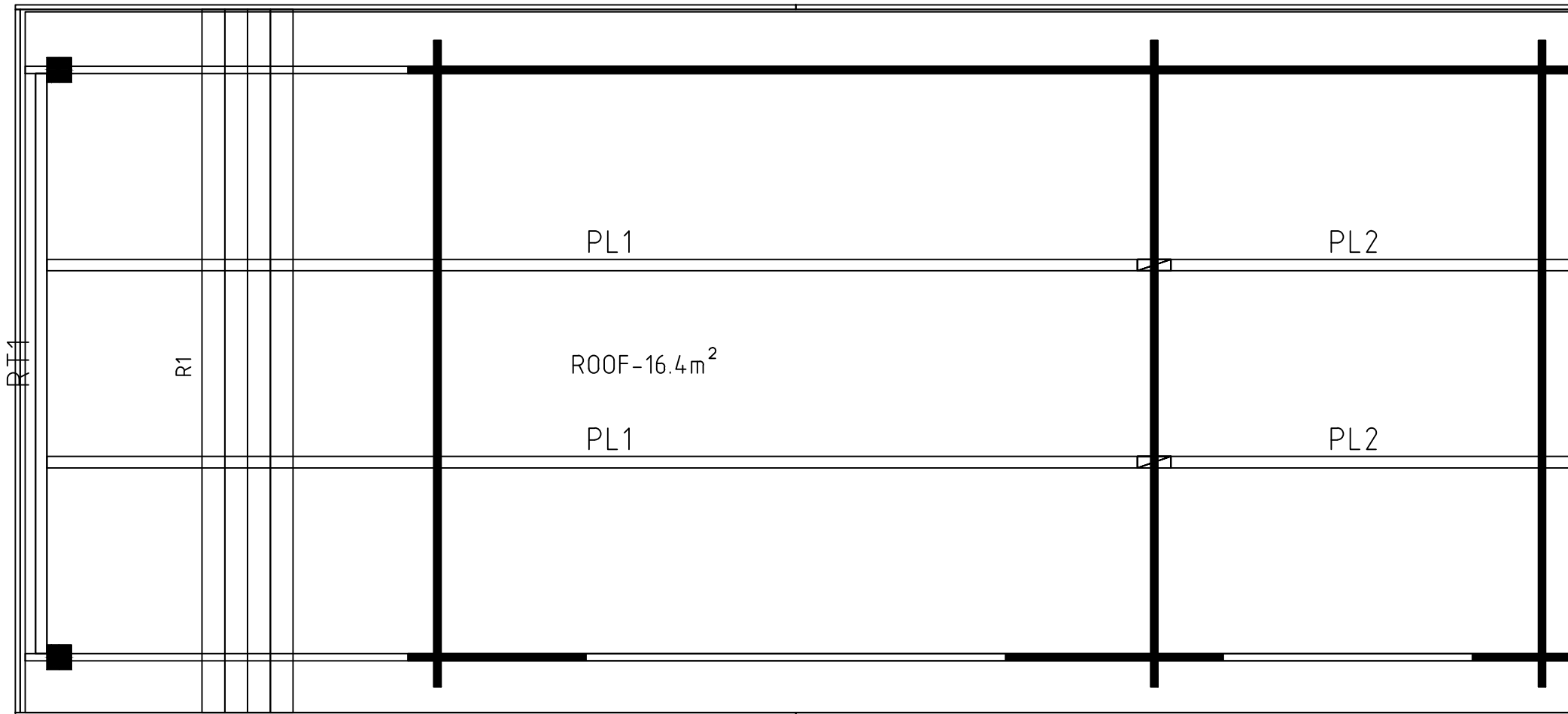

Model	Maria 28 ABSD	Drawing	PLAN	Page
		Drawn by	R.T	Material
		Date	13.07.2023	File
		Scale	1:20	



Model	Maria 28 ABSD	Drawing	ROOF	Page	
		Drawn by	R.T	Material	28x114
		Date	13.07.2023	File	Maria 28 ABSD.dwg
				Scale	1:20

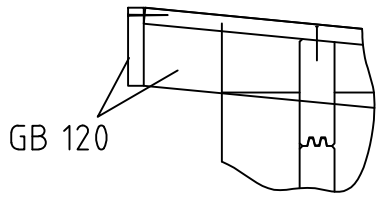

GB 120

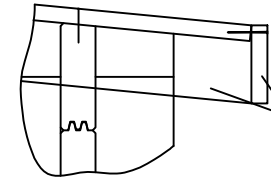

GB 120

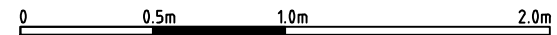
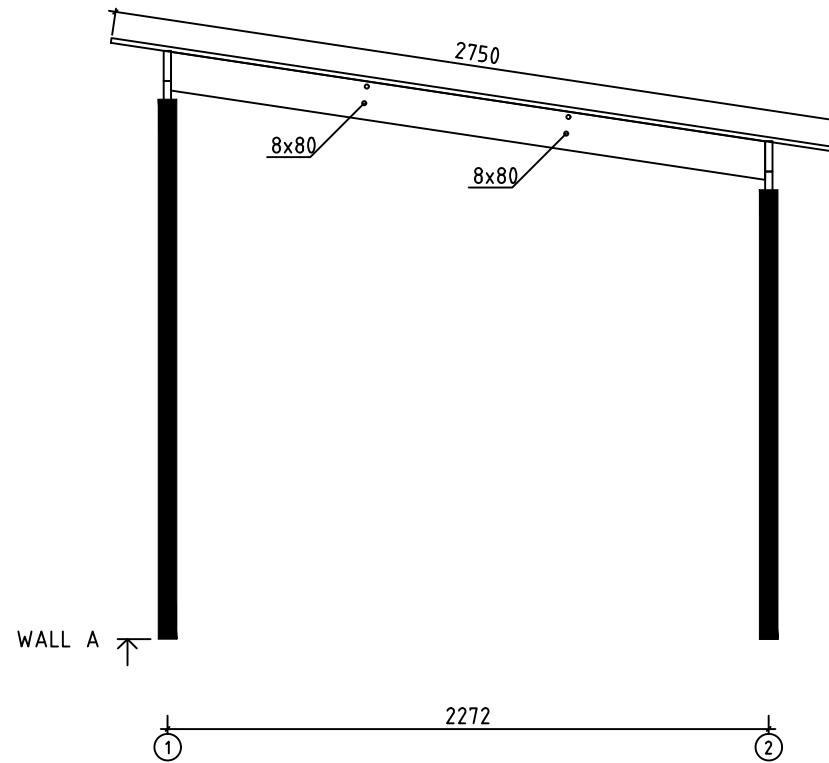

Model	Maria 28 ABSD	Drawing	WALL A	Page	2
		Drawn by	R.T	Material	2.8x11.4
		Date	13.07.2023	File	Maria 28 ABSD.dwg
		Scale	1:20		

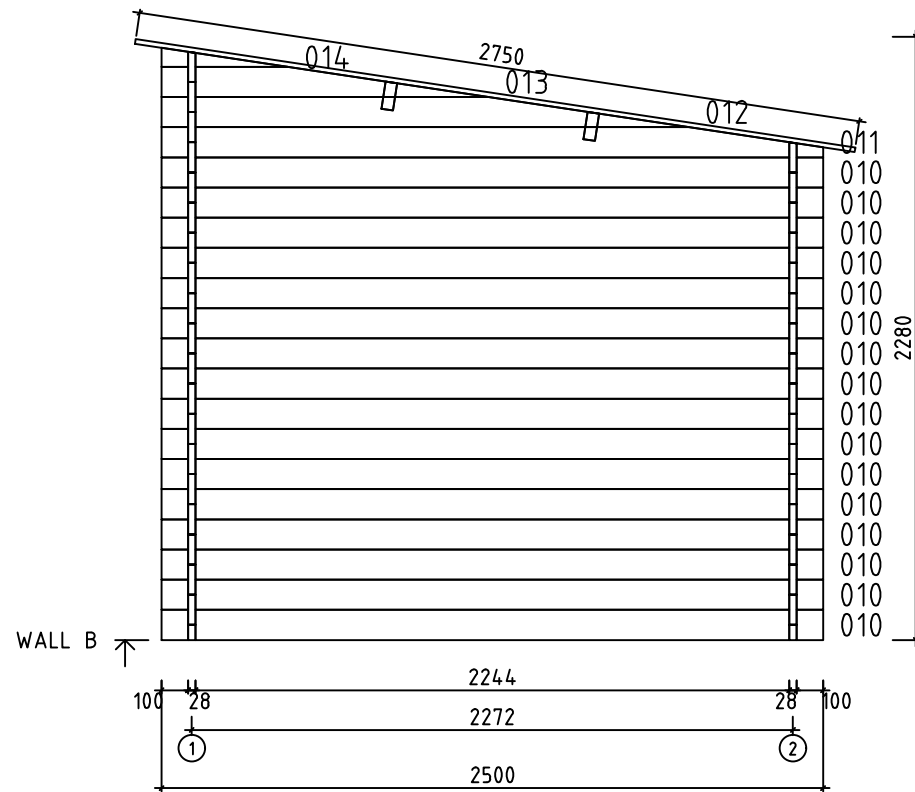

0 0.5m 1.0m 2.0m

Model	Maria 28 ABSD	Drawing	WALL B	Page	3	
	Drawn by	R.T	Material	2.8x11.4	Scale	1:20
	Date	13.07.2023	File	Maria 28 ABSD.dwg		

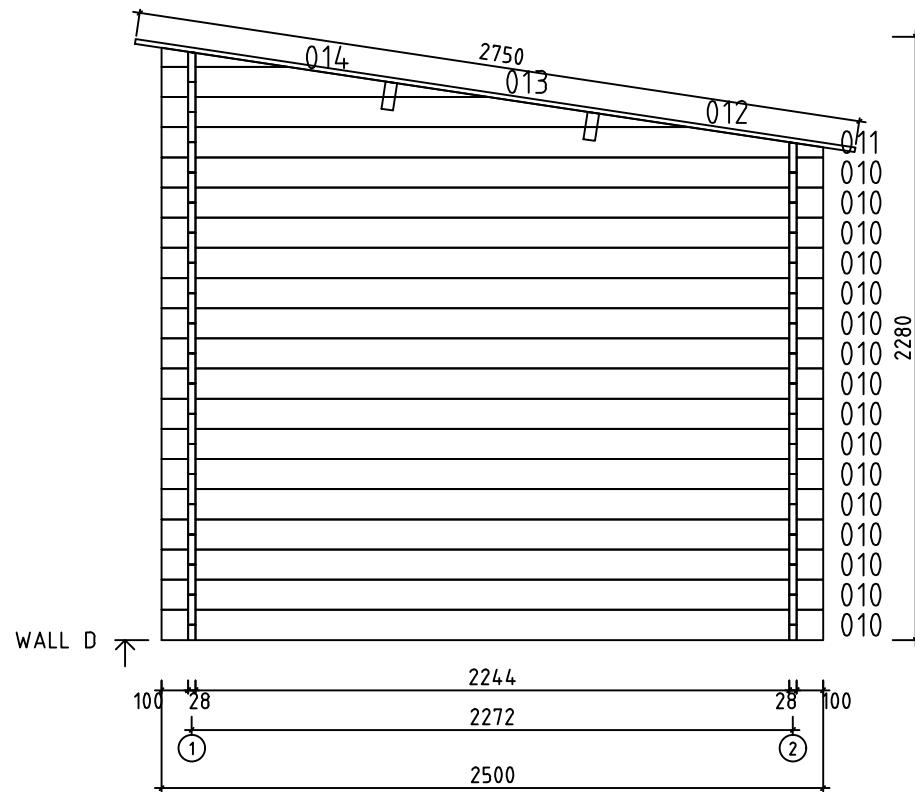

0 0.5m 1.0m 2.0m

Model	Maria 28 ABSD	Drawing	WALL D	Page	5	
	Drawn by	R.T	Material	2.8x11.4	Scale	1:20
	Date	13.07.2023	File	Maria 28 ABSD.dwg		

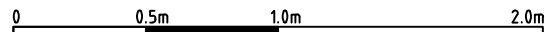
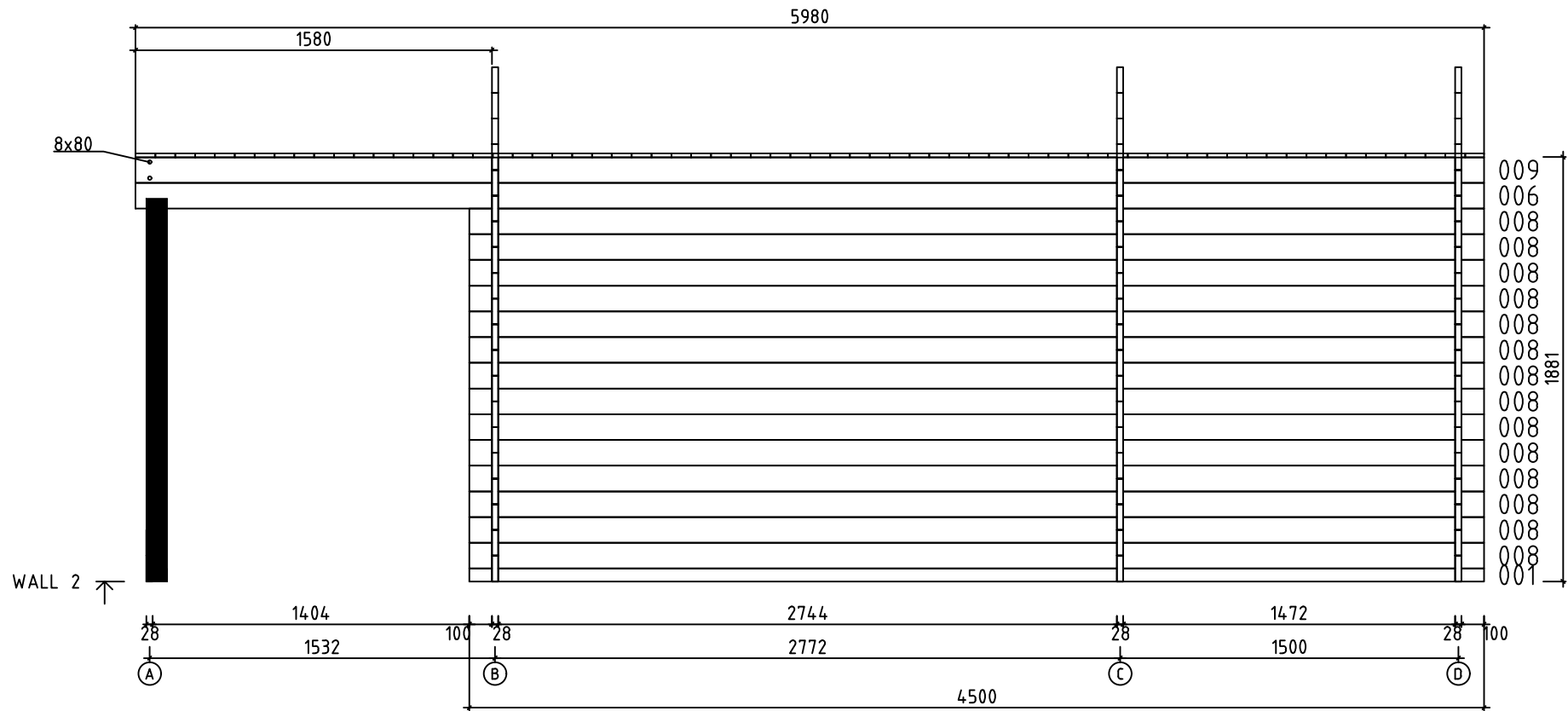

Model	Maria 28 ABSD	Drawing	WALL 2	Page	8
		Drawn by	R.T	Material	2.8x11.4
		Date	13.07.2023	File	Maria 28 ABSD.dwg
		Scale	1:20		