

Alphol 

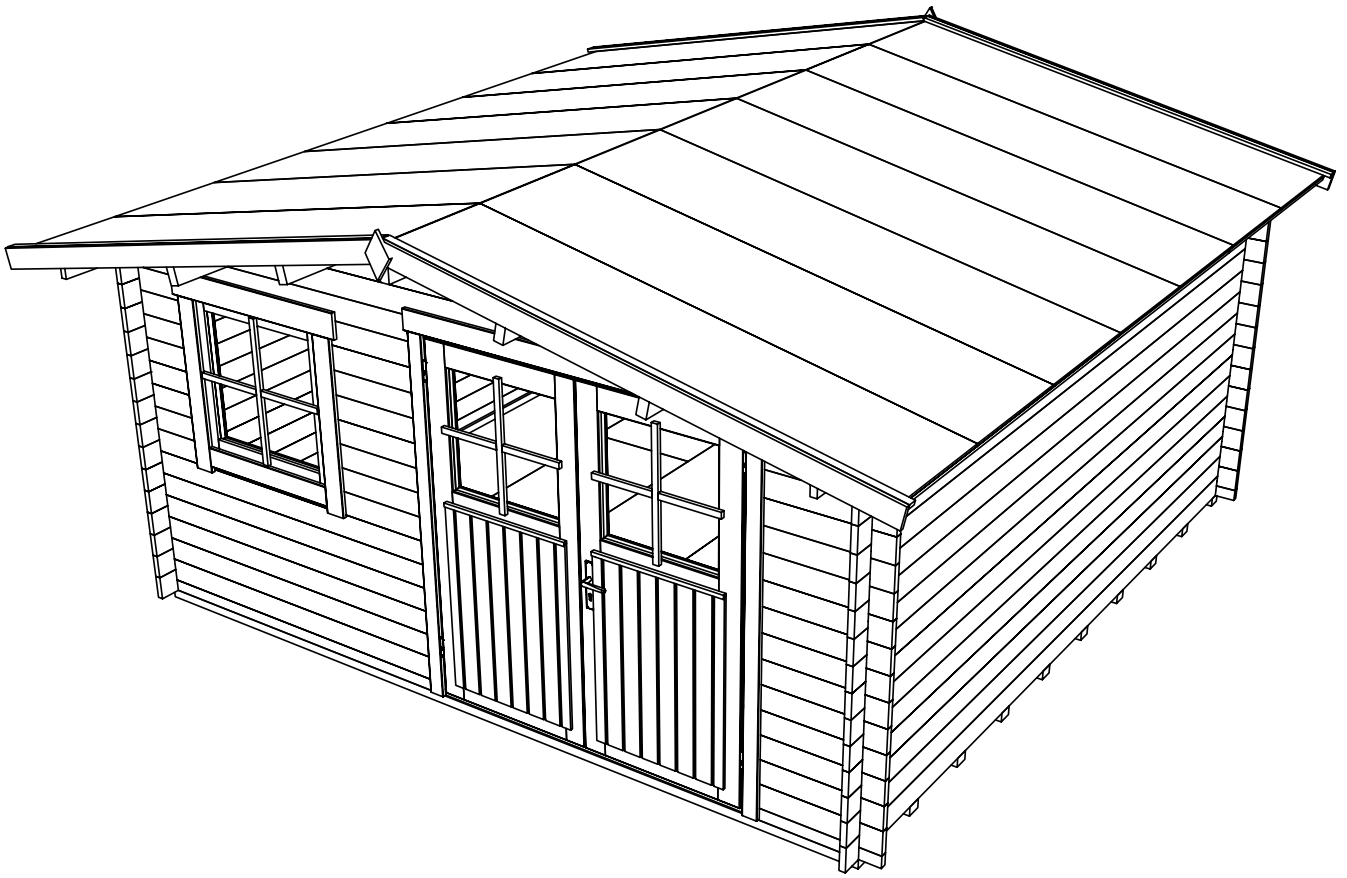

Valeria 28

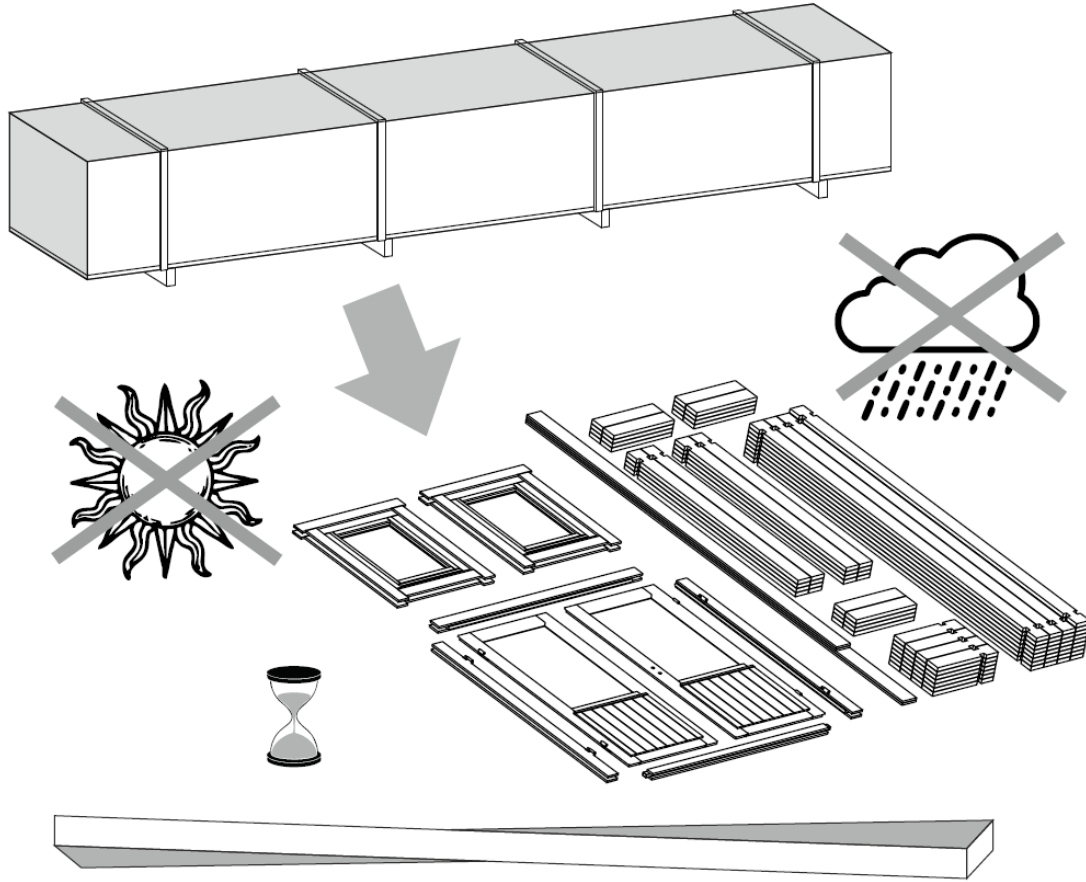

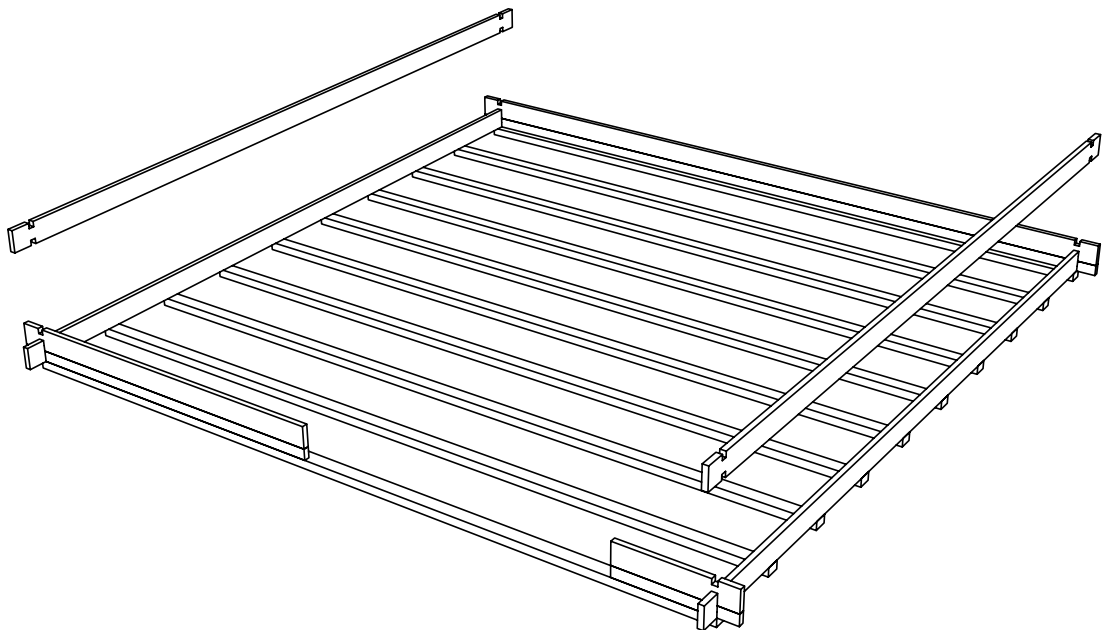
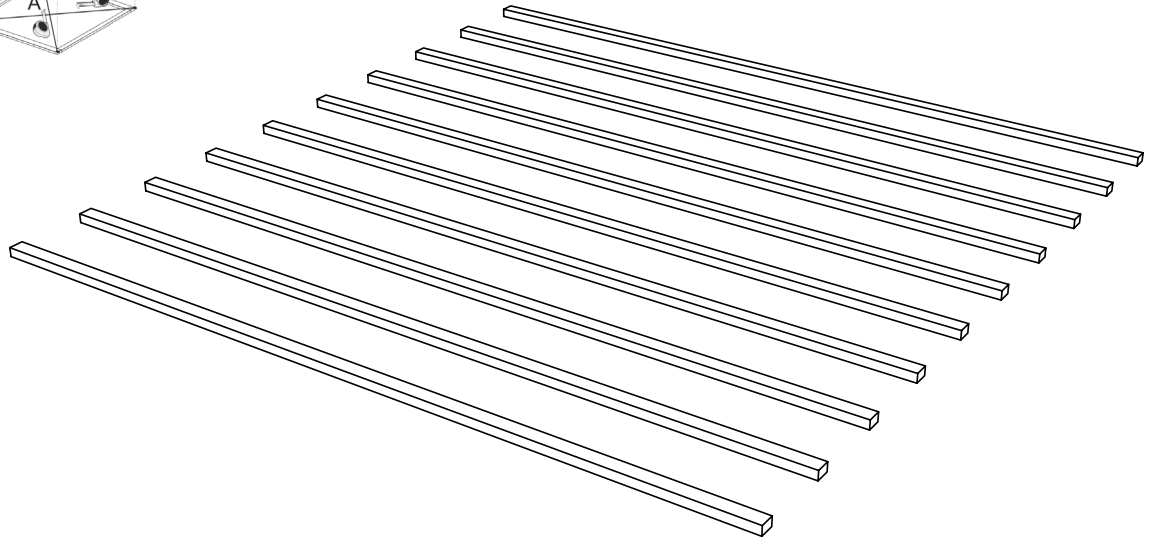
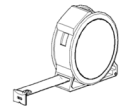
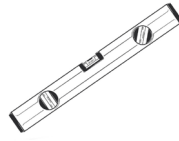
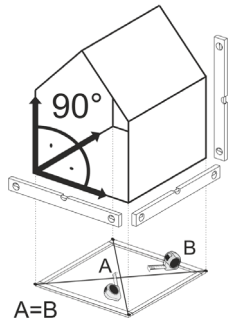

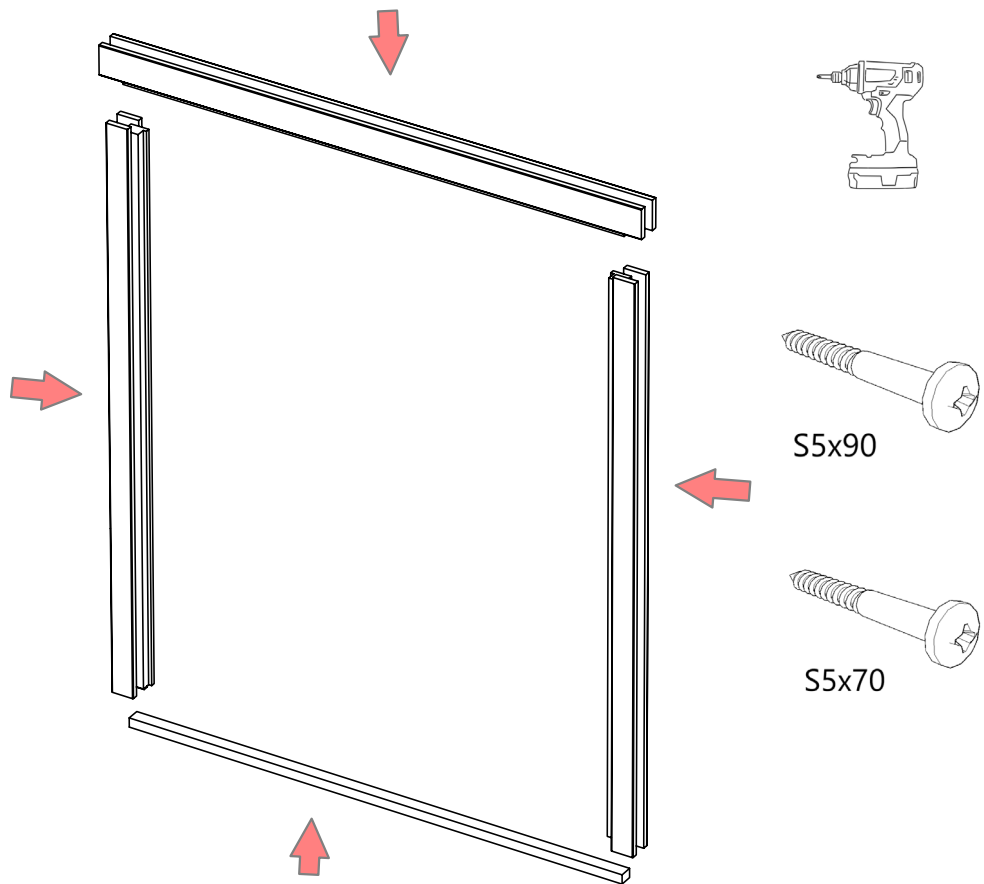
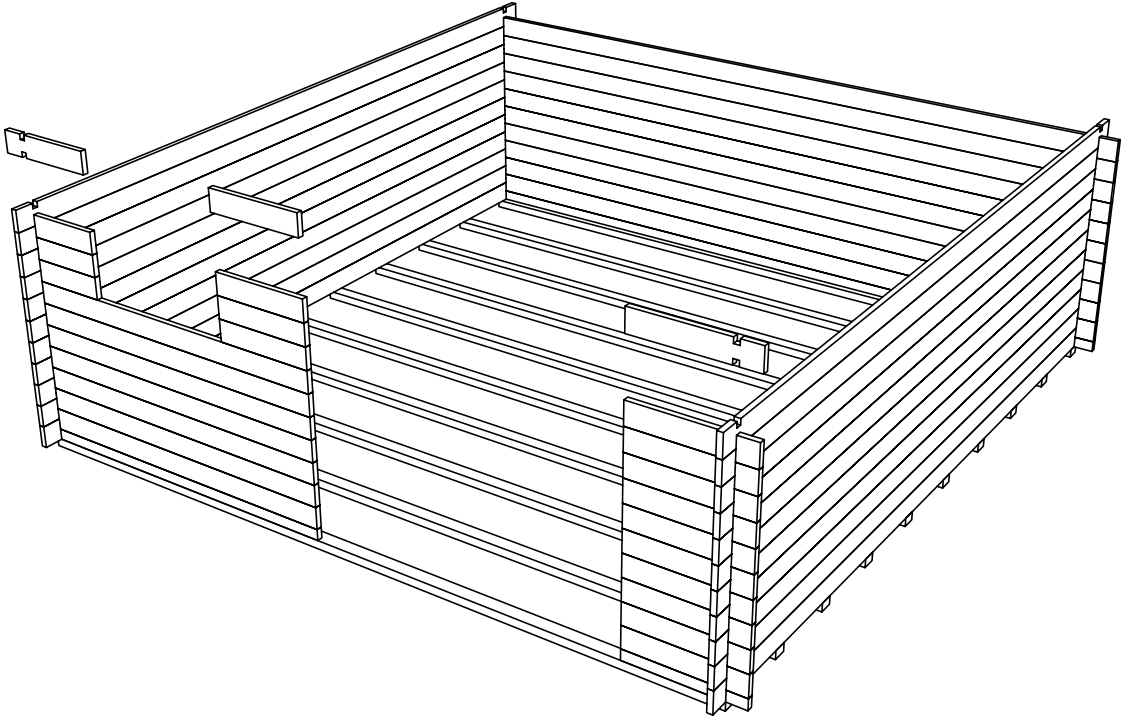

2

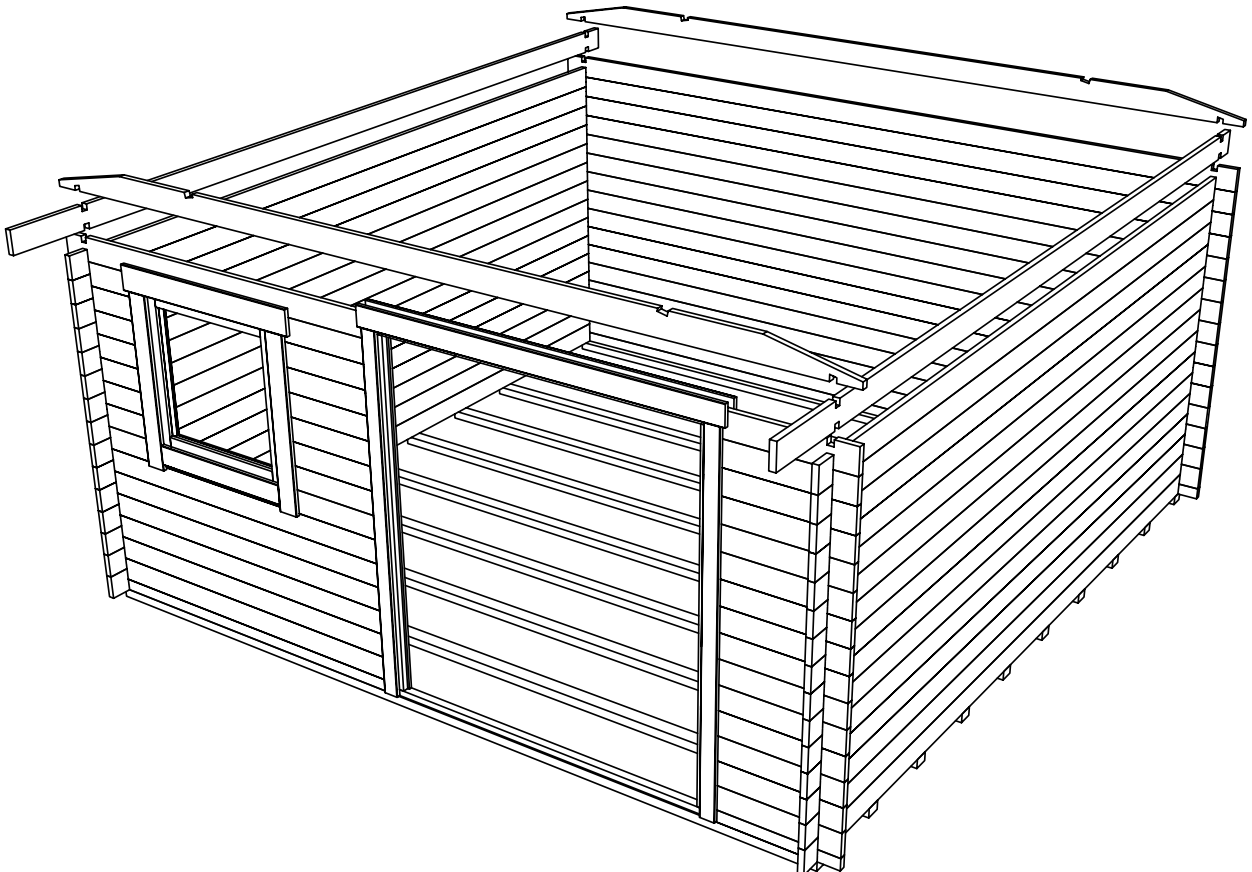
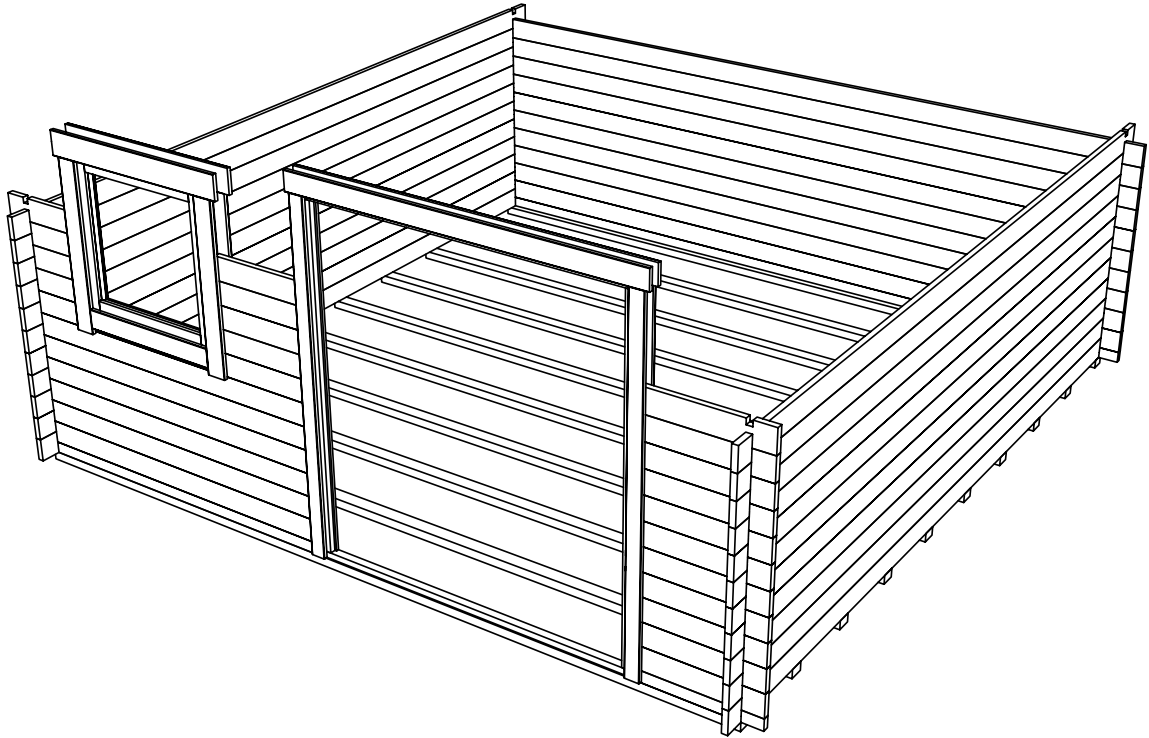

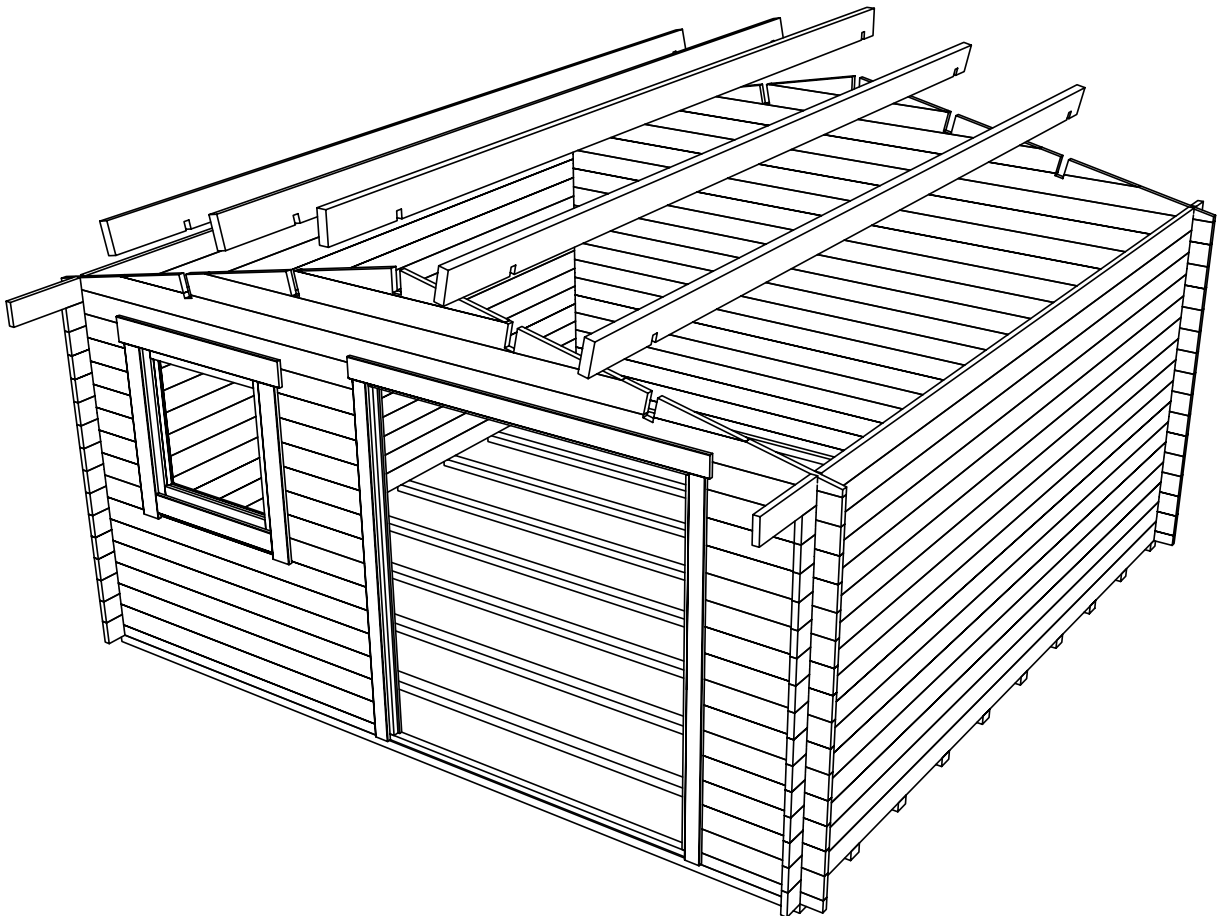
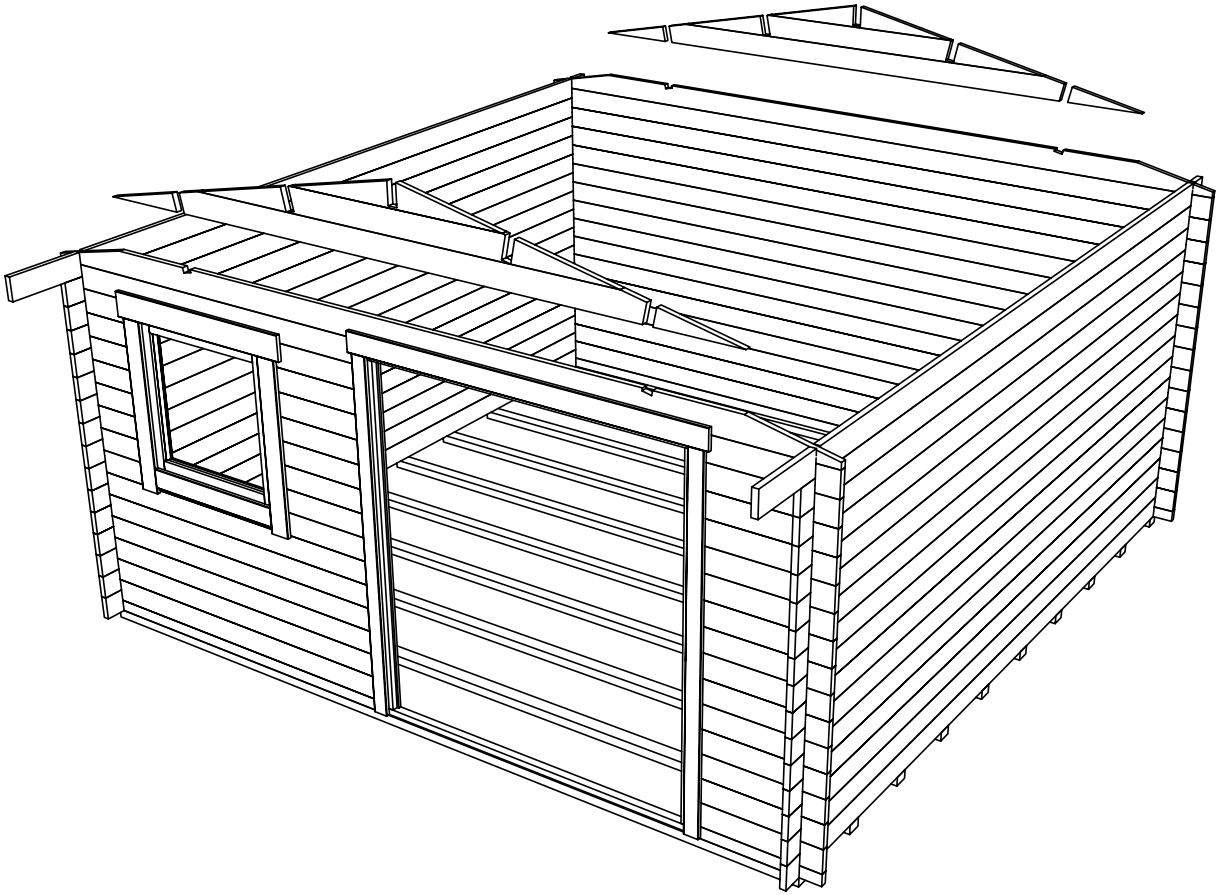

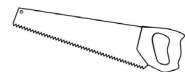
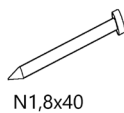
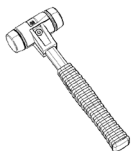
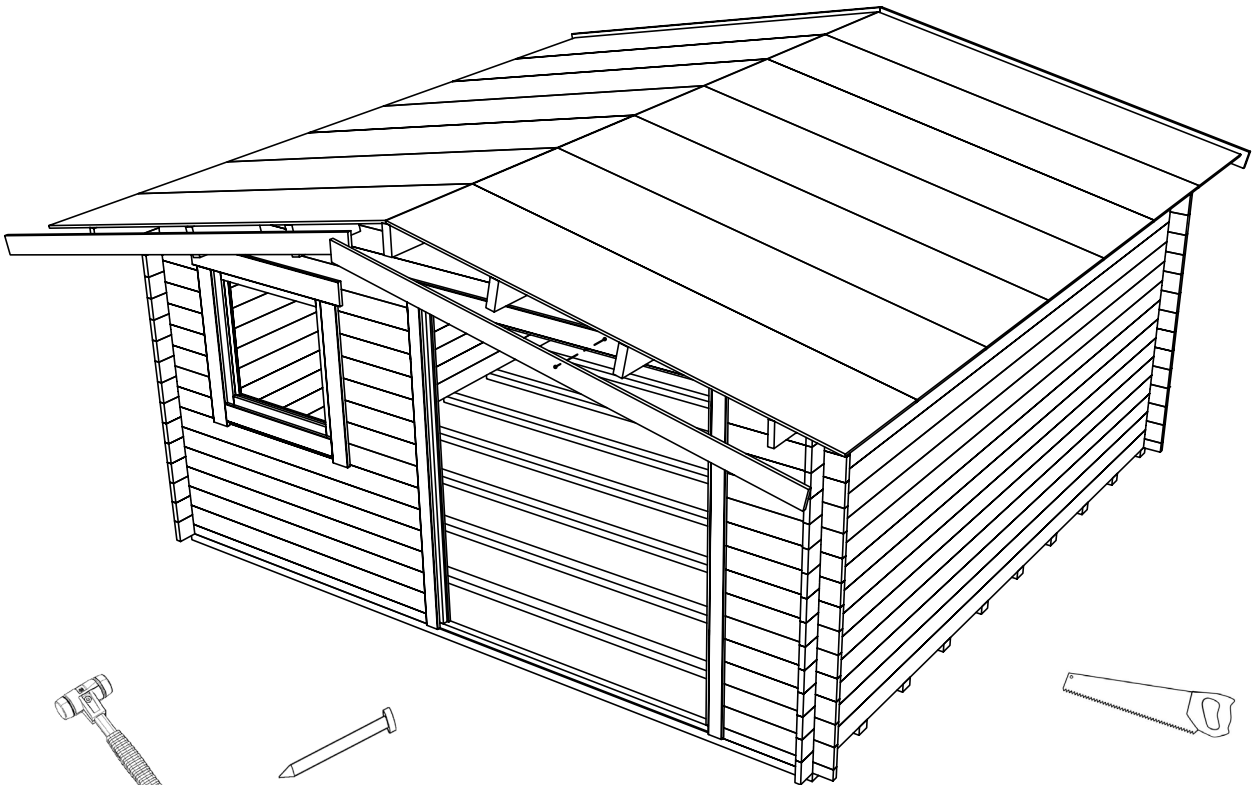
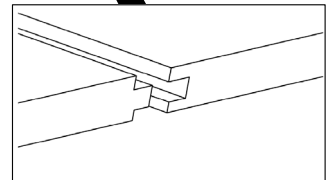
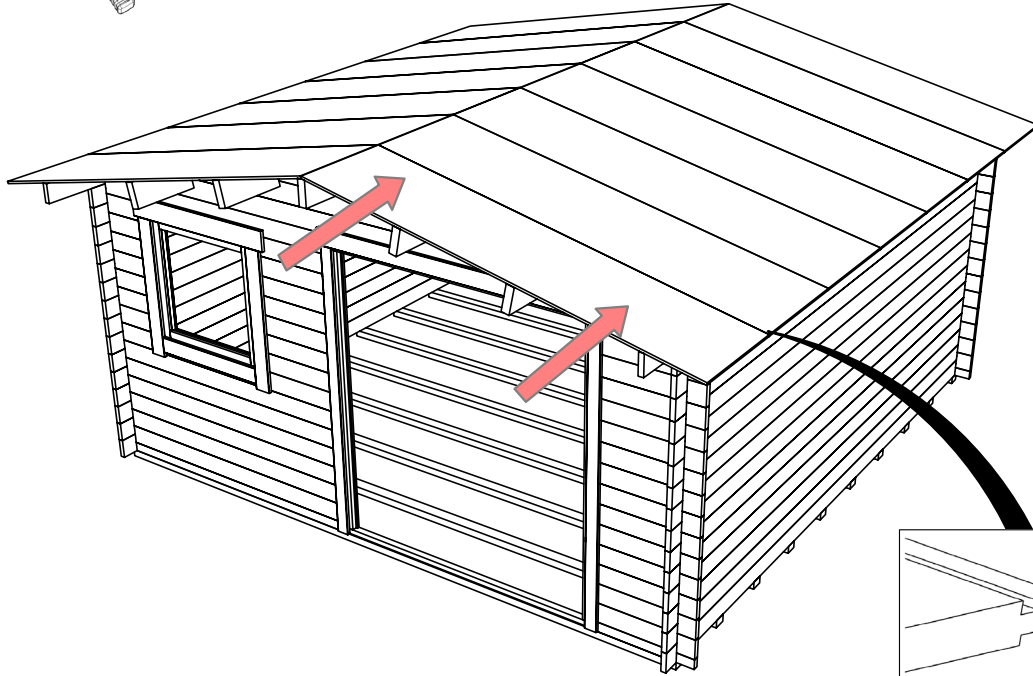
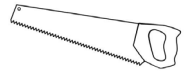
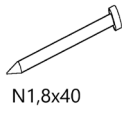
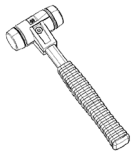



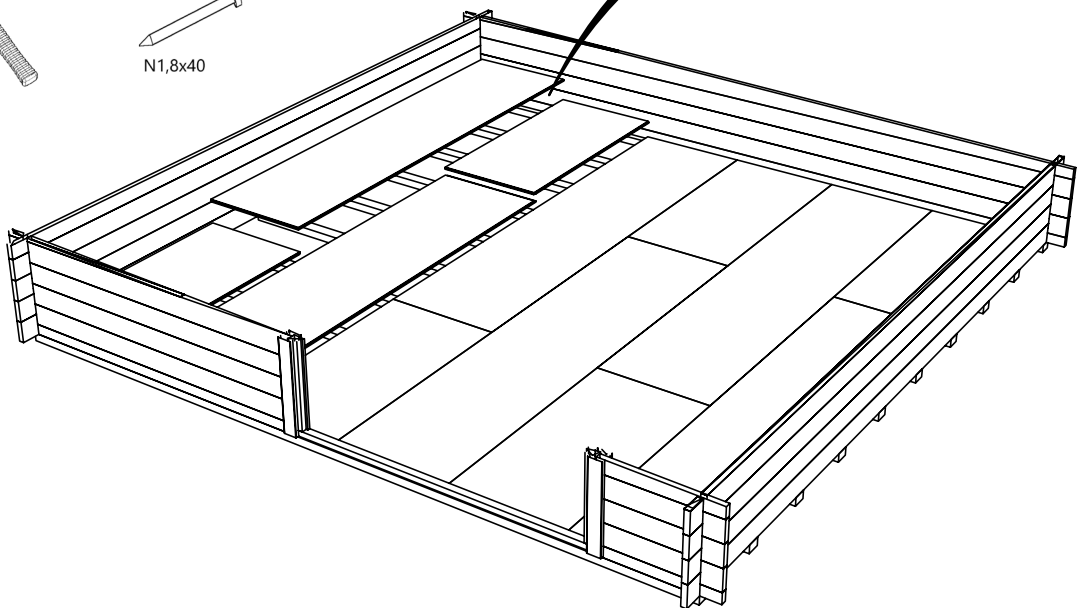
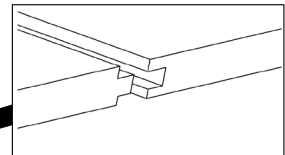
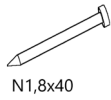
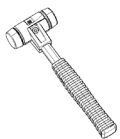
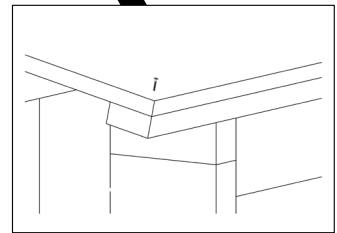
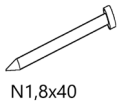
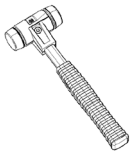
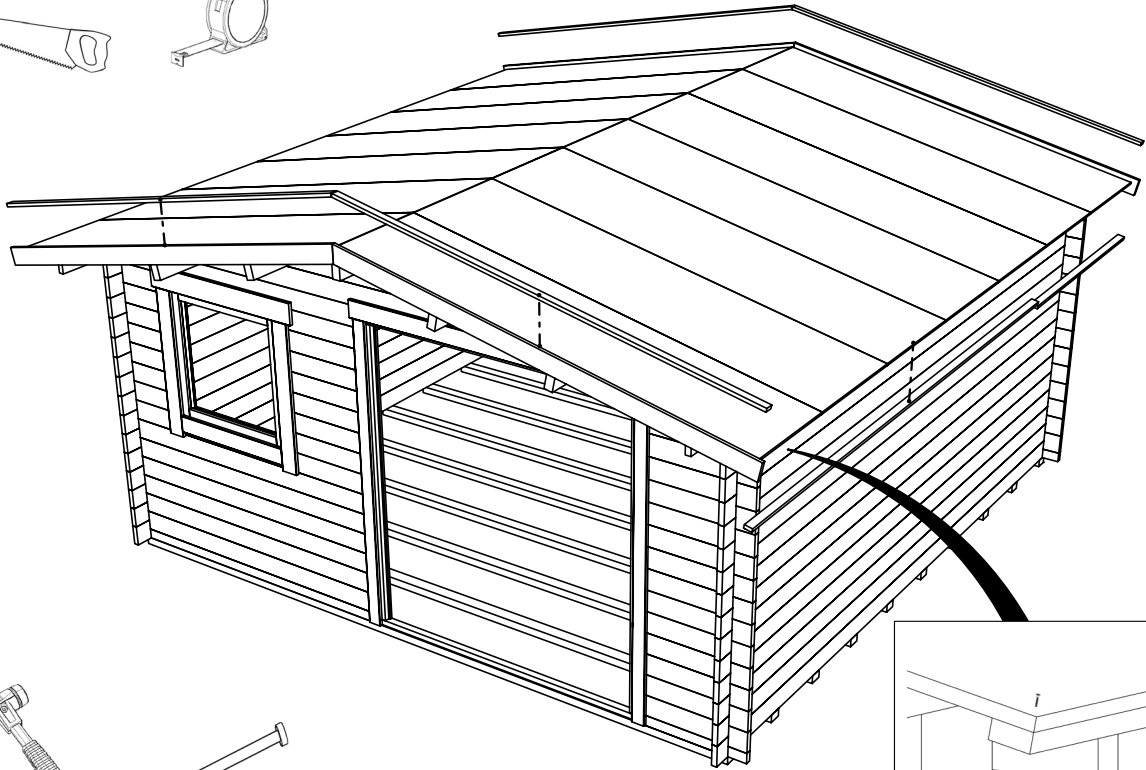
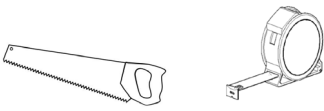



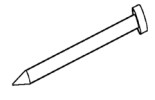
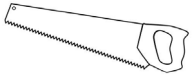



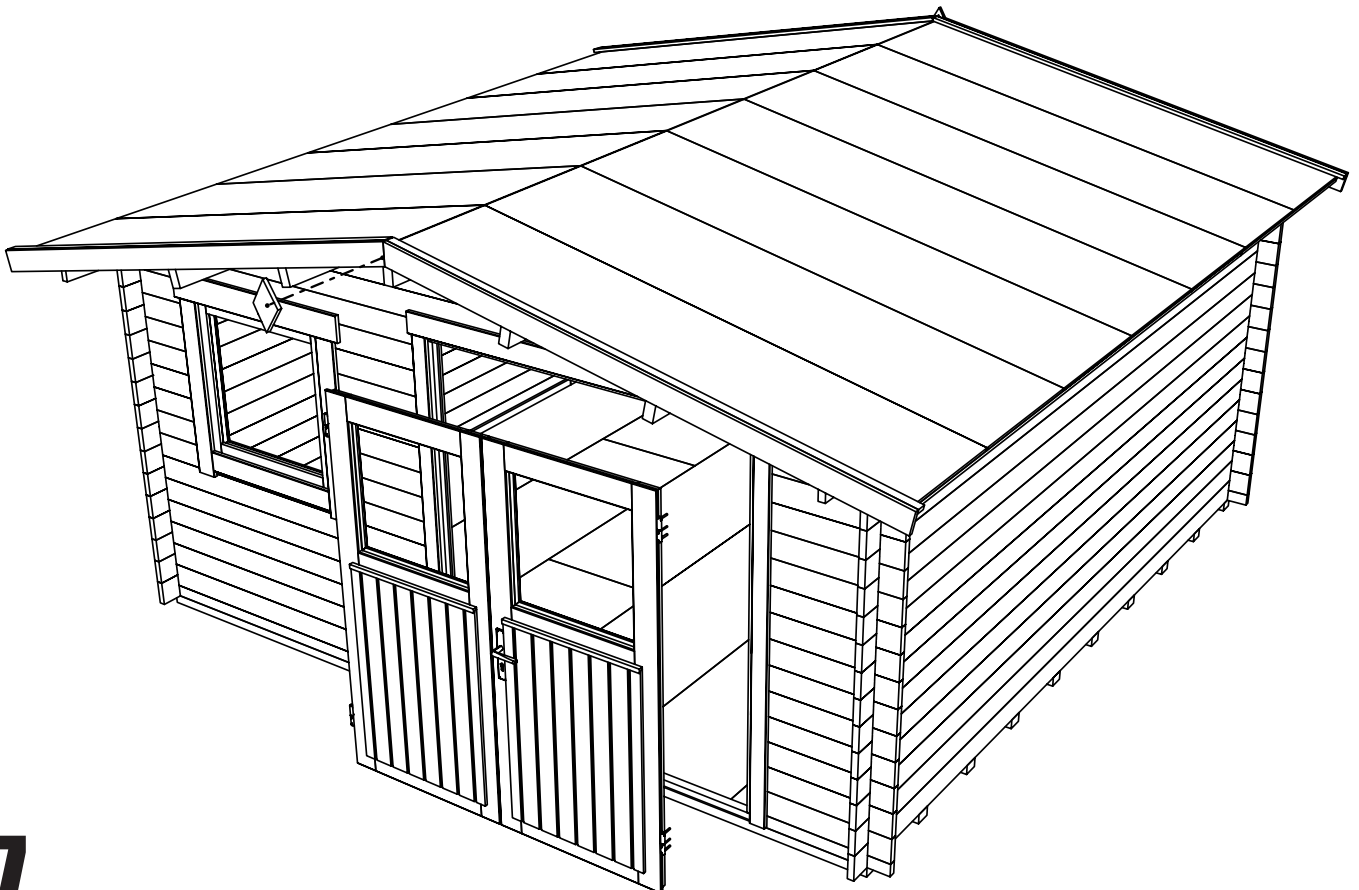
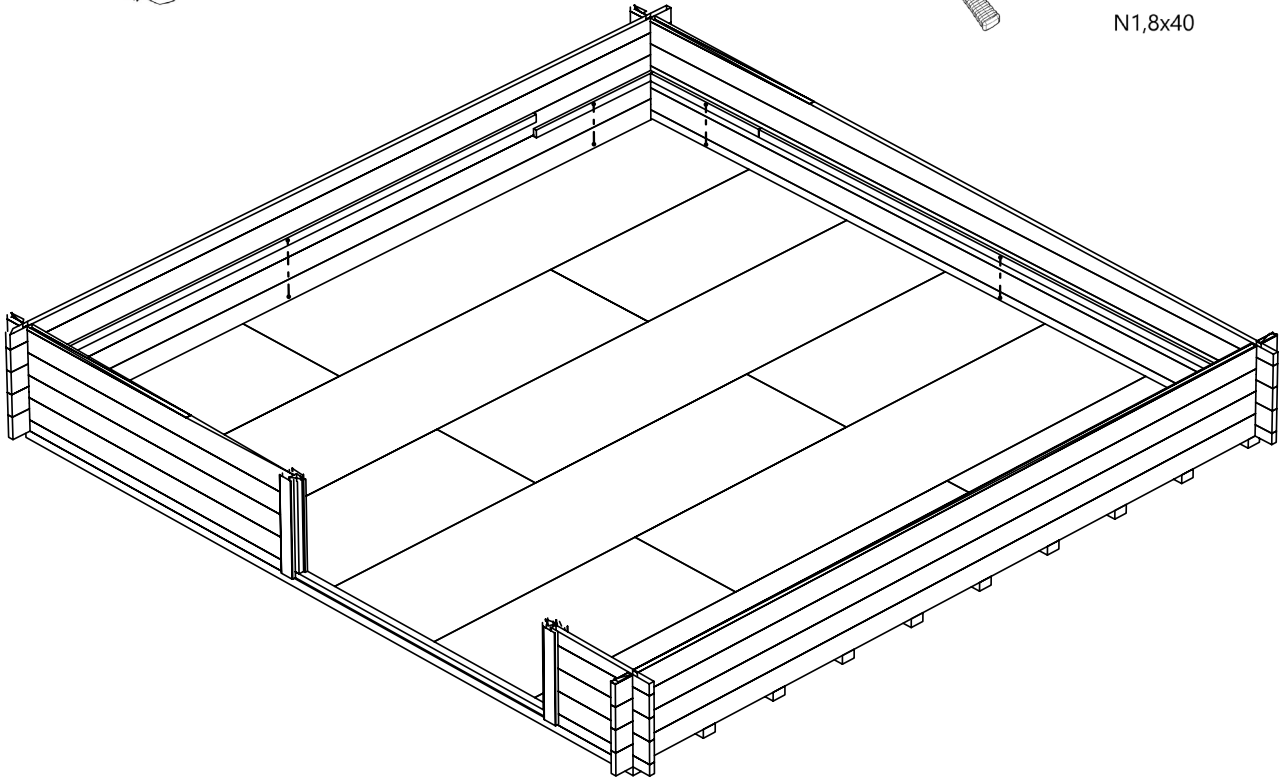

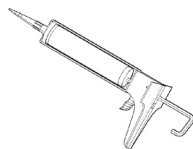
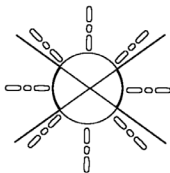
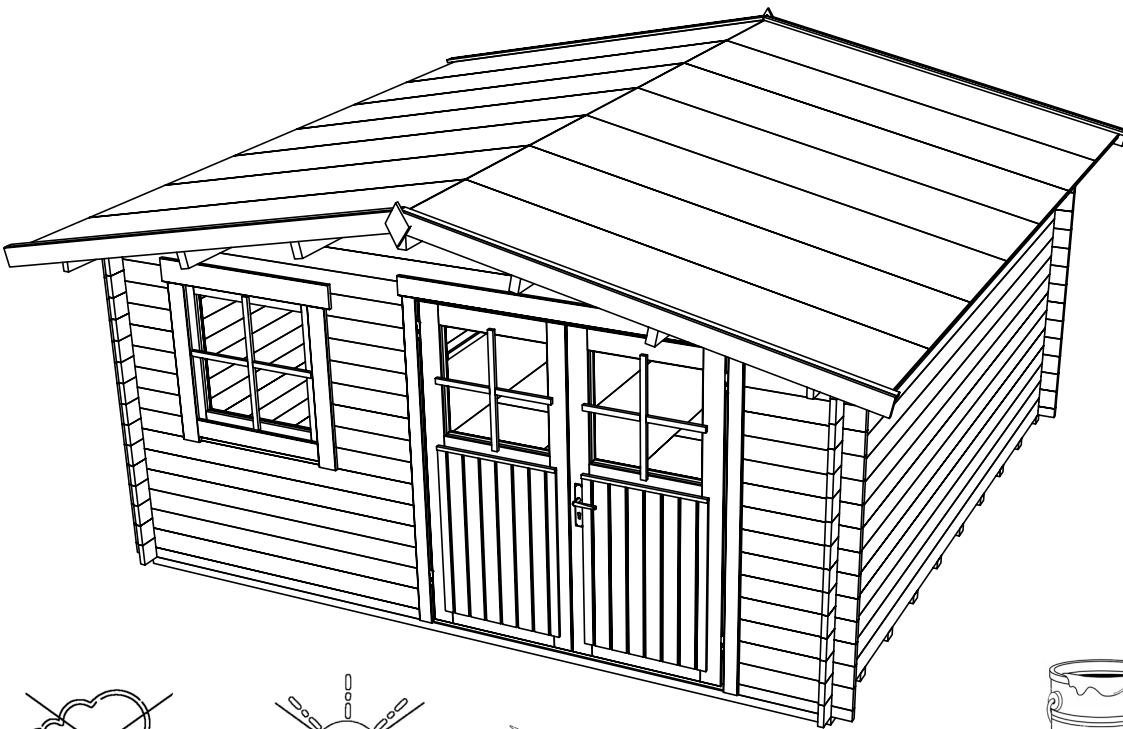
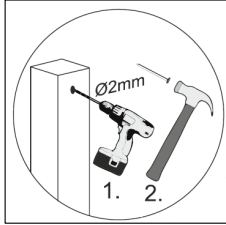
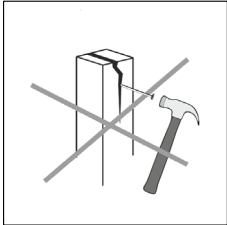
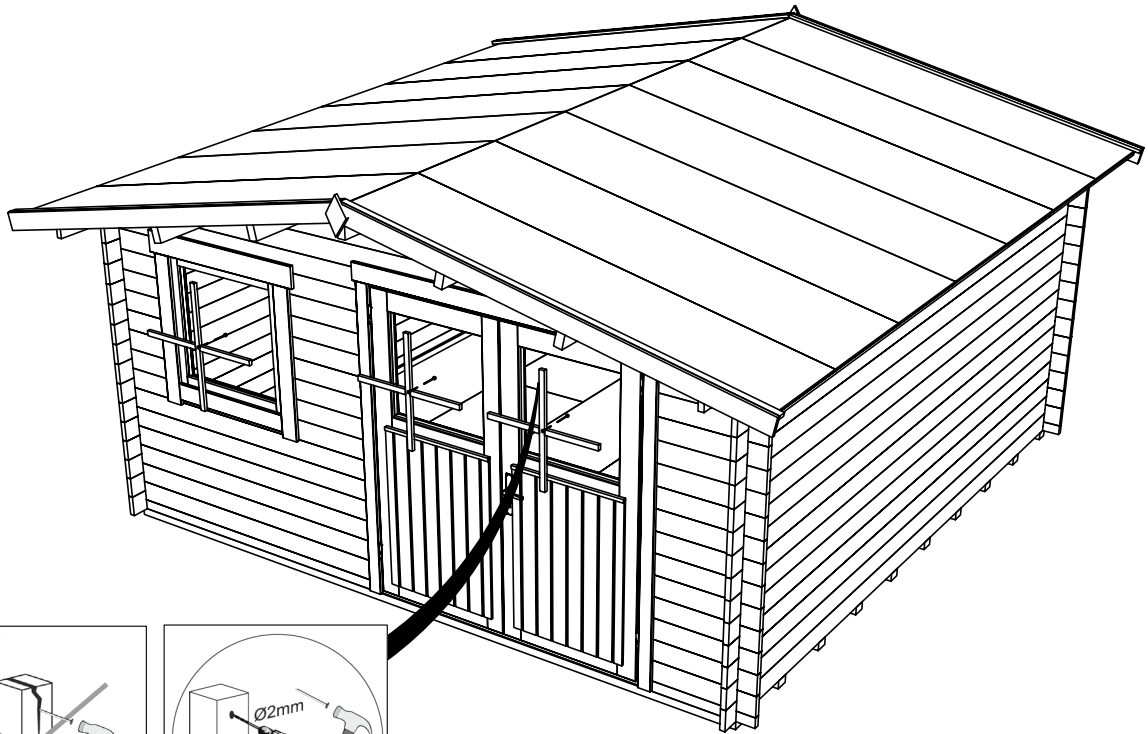

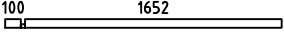
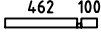
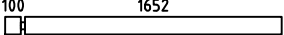
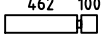

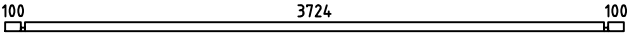
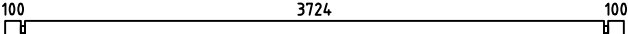
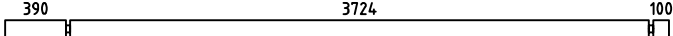
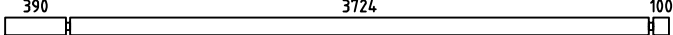
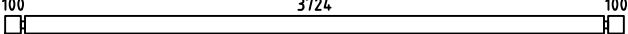
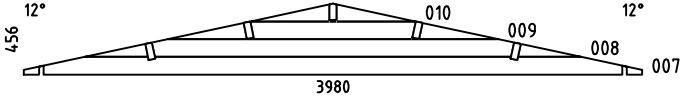
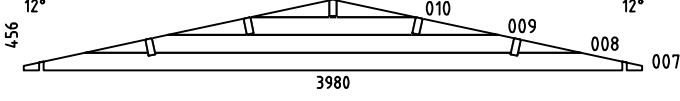

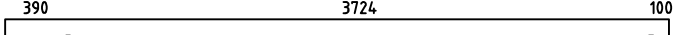
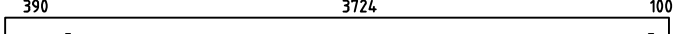
N1,8x40





| Pos   | Specification-Spezifikation-Specificatie-Nomenclature-Elementi-Especificacion<br>Valeria28   | Qty      | Profile<br>(mm) | Lenght<br>(mm) |
|-------|--|----------|-----------------|----------------|
| 001   |   | 1        | 28x57           | 1780           |
| 002   |   | 1        | 28x57           | 590            |
| 003   |   | 8        | 28x114          | 1780           |
| 004   |   | 15       | 28x114          | 590            |
| 005   |   | 7        | 28x114          | 500            |
| 006   |   | 7        | 28x114          | 500            |
| 011   |   | 1        | 28x57           | 3980           |
| 012   |   | 45       | 28x114          | 3980           |
| 013   |   | 1        | 28x114          | 4270           |
| 014   |   | 1        | 28x114          | 4270           |
| EXTRA |   | 1        | 28x114          | 3980           |
| W1-1  |    | 1        |                 |                |
| W2-1  |    | 1        |                 |                |
| F1    | FOUNDATION-FUNDAMENT-FONDATION-FONDAZIONE-VIGAS DE CIMENTACIÓN<br>                                      | 10       | 70x44           | 3780           |
| PL1   | PURLIN-DAKBALK-DACHPFETTE-PANNE-ARCARECCIO-CORREA<br>   | 4        | 44x144          | 4270           |
| PL2   | PURLIN-DAKBALK-DACHPFETTE-PANNE-ARCARECCIO-CORREA<br>   | 1        | 44x144          | 4270           |
| FLB-1 | Floor beading 3000-Fussbodenleiste-Plinten-Moulure de finition-Listello pavimento-Liston de suelo<br> | 5        | 18x40           | 15rmt.         |
| GB-1  | Gable board 95-Giebelblende-Gevelplank-Planche de rive-Tavola di bordo-Tabla de borde<br>             | 4        | 18x95           | 2280           |
|       | OSB<br>   | 23       | 625x2500        | 12mm           |
| RL-1  | Roofing lath 3000-Giebelleiste-Gevellijst-Latte de rive-Listello di bordo-Listones de borde<br>       | 7        | 18x40           | 21rmt.         |
| D     | Diamond<br>   | 2        |                 |                |
| Model | Valeria28  | Material | Page 1/2        |                |



H = 1.600 m  
 TOTAL: 13.87 m<sup>2</sup>

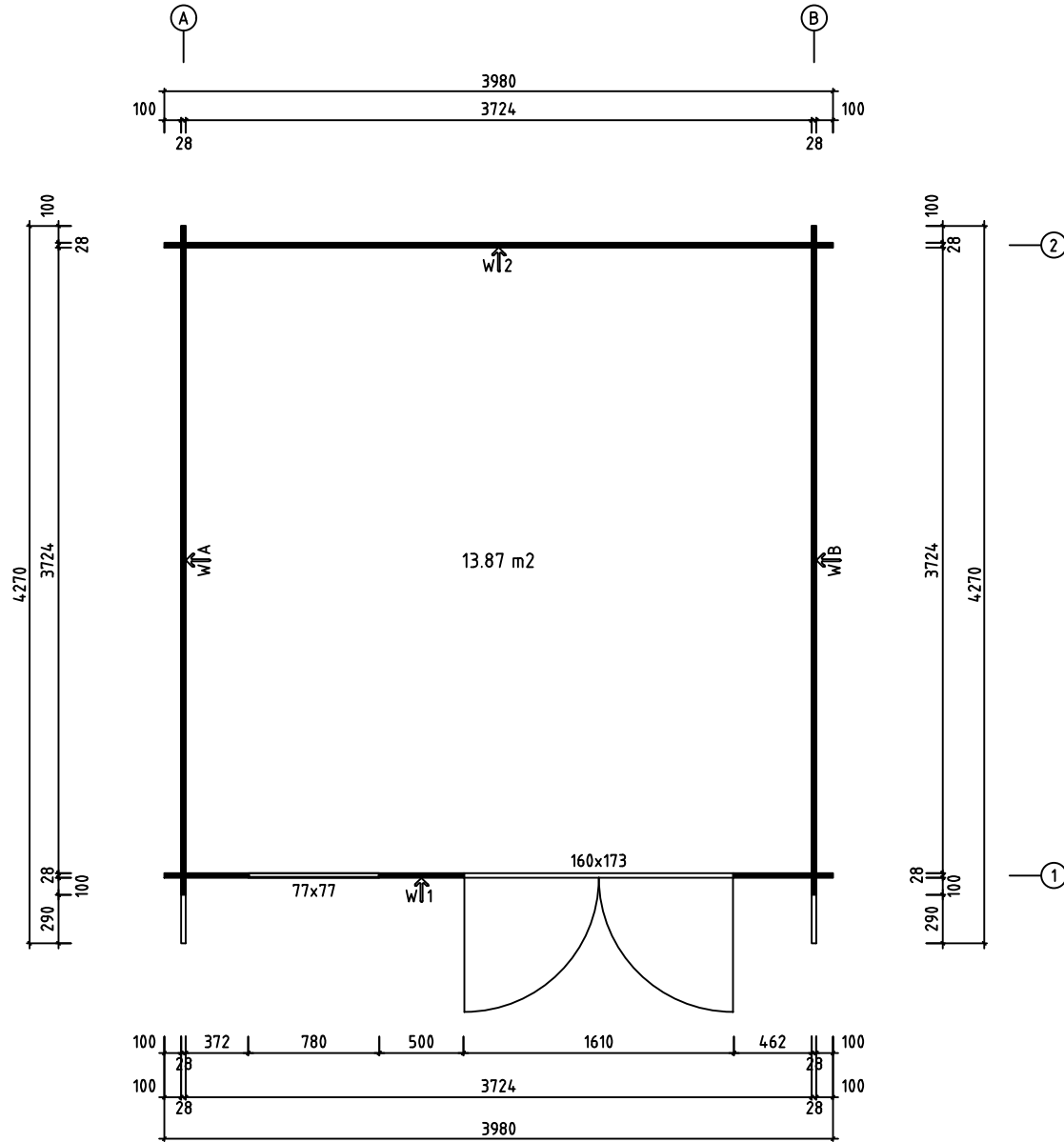

0 0.5m 1.0m 2.0m

|       |           |  |          |            |                    |
|-------|-----------|--|----------|------------|--------------------|
| Model | Valeria28 |  | Drawing  | PLAN       | Page               |
|       |           |  | Drawn by | R.T        | Material 28x114    |
|       |           |  | Date     | 08.05.2024 | File Valeria28.dwg |
|       |           |  | Scale    | 1:30       |                    |

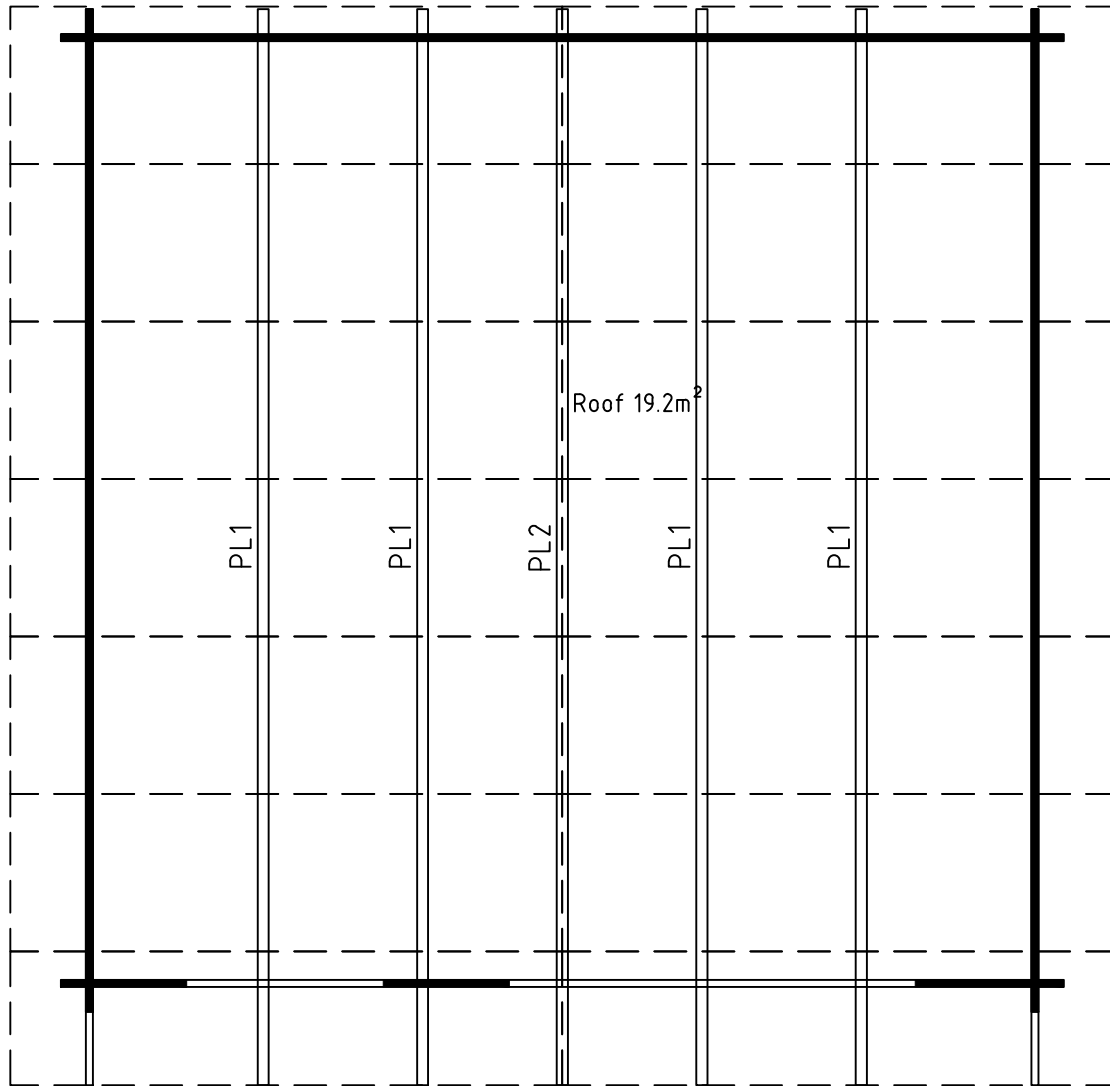

0 0.5m 1.0m 2.0m

|   |           |            |          |               |       |      |
|---|-----------|------------|----------|---------------|-------|------|
| Model   | Valeria28 |            | Drawing  | ROOF          | Page  |      |
|  | Drawn by  | R.T        | Material | 28x114        | Scale | 1:30 |
|   | Date      | 08.05.2024 | File     | Valeria28.dwg |       |      |

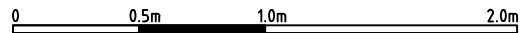
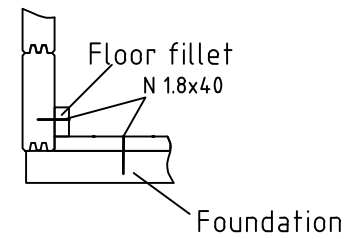
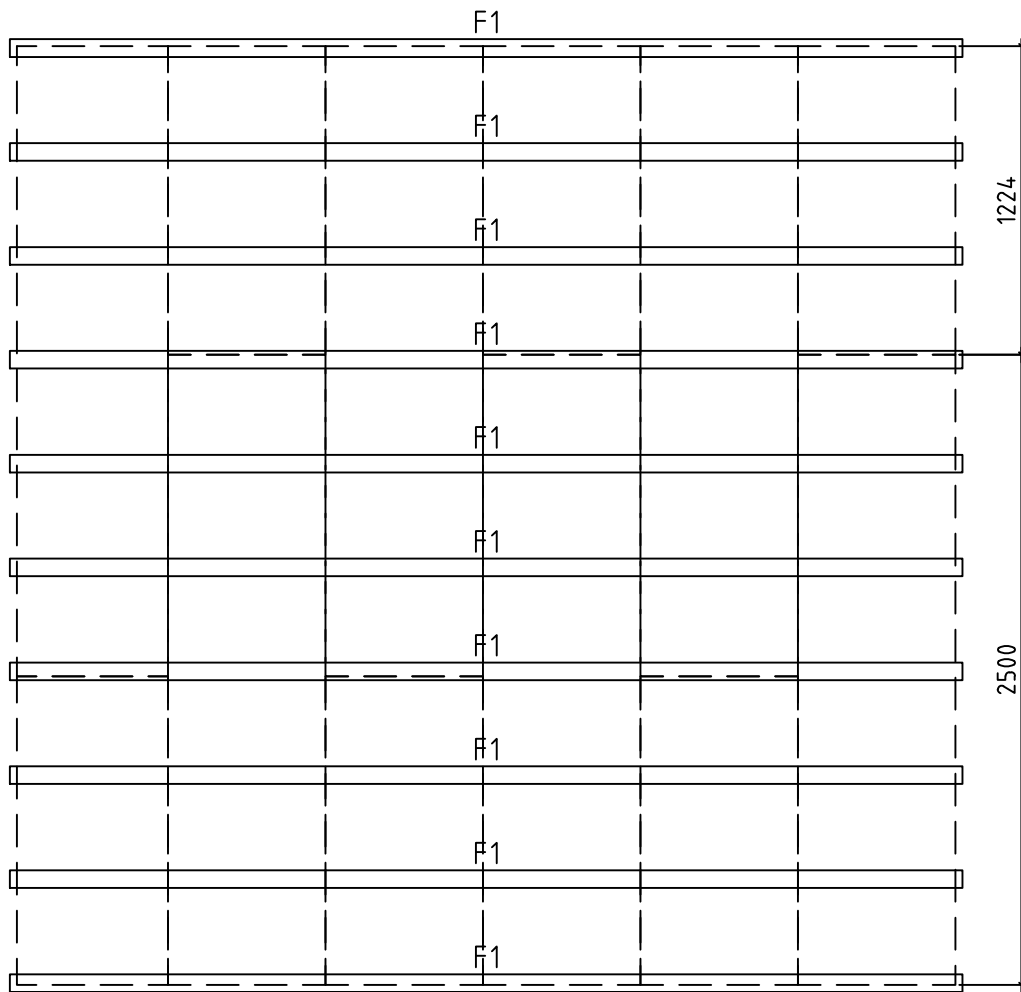

|   |           |            |            |               |       |
|---|-----------|------------|------------|---------------|-------|
| Model   | Valeria28 | Drawing    | FOUNDATION | Page          |       |
|  | Drawn by  | R.T        | Material   | 28x114        | Scale |
|   | Date      | 08.05.2024 | File       | Valeria28.dwg |       |





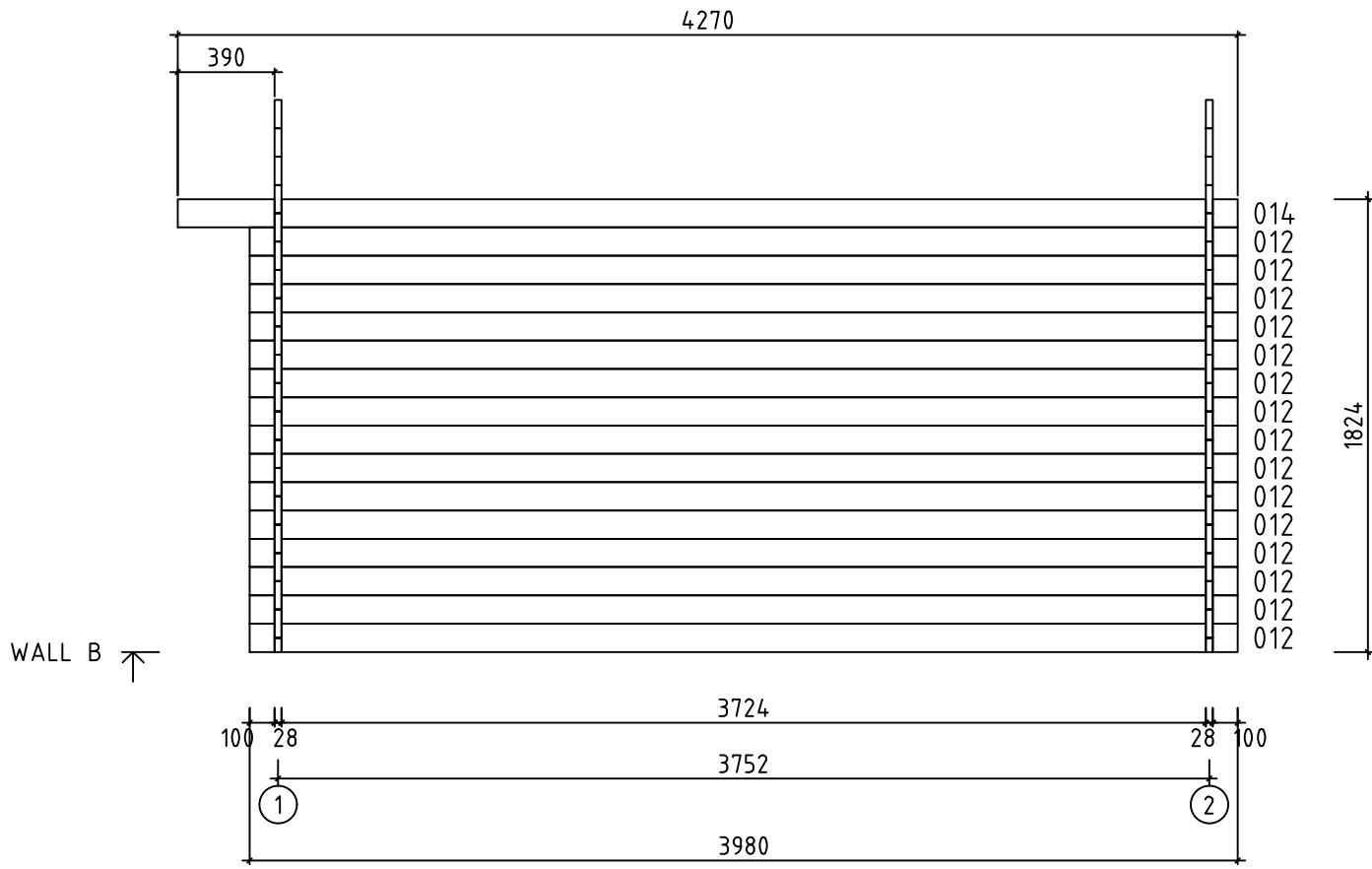

0 0.5m 1.0m 2.0m

|   |           |          |            |          |               |
|---|-----------|----------|------------|----------|---------------|
| Model   | Valeria28 | Drawing  | WALL B     | Page     | 4             |
|  |           | Drawn by |            | Material | 2.8x11.4      |
|   |           | Date     | 08.05.2024 | File     | Valeria28.dwg |
|   |           |          |            | Scale    | 1:30          |

N 1.8x40

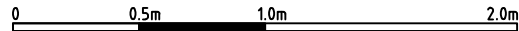
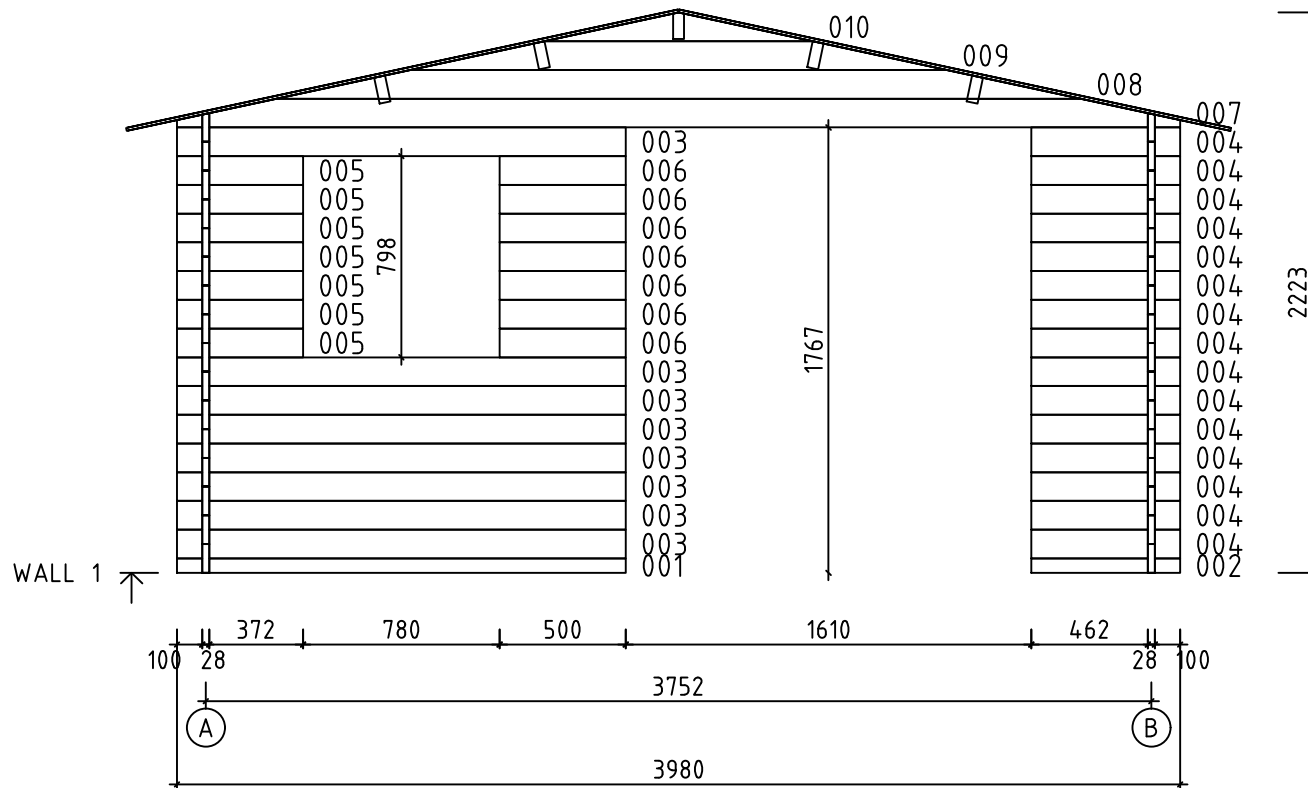
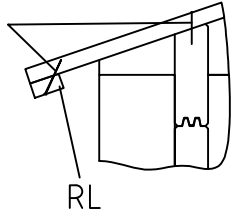

|       |           |            |          |               |      |
|-------|-----------|------------|----------|---------------|------|
| Model | Valeria28 | Drawing    | WALL 1   | Page          | 5    |
|       | Drawn by  | Material   | 2.8x11.4 | Scale         | 1:30 |
|       | Date      | 08.05.2024 | File     | Valeria28.dwg |      |

