

Alpho**h**ol

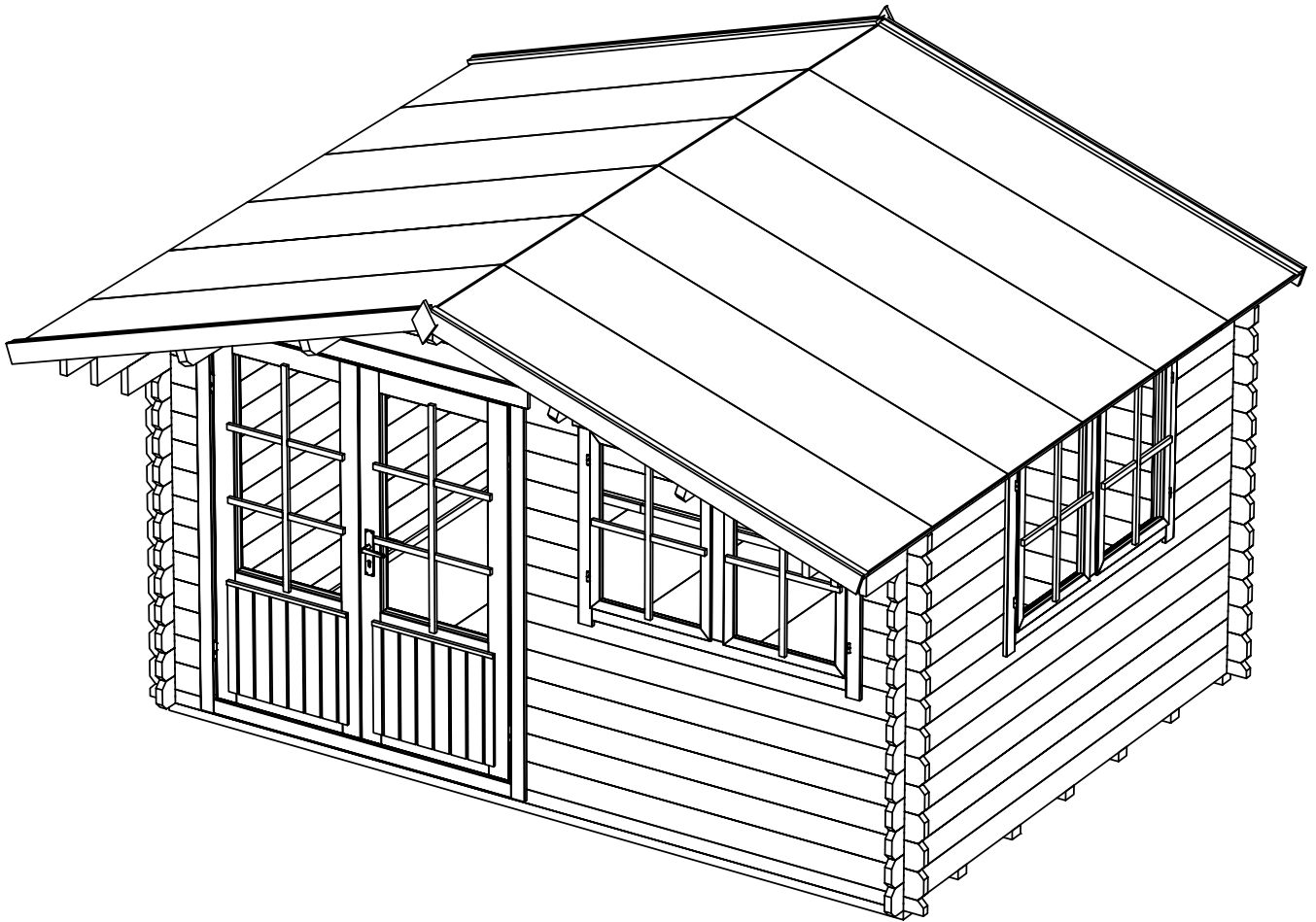

**Gabriel 34 4x3**

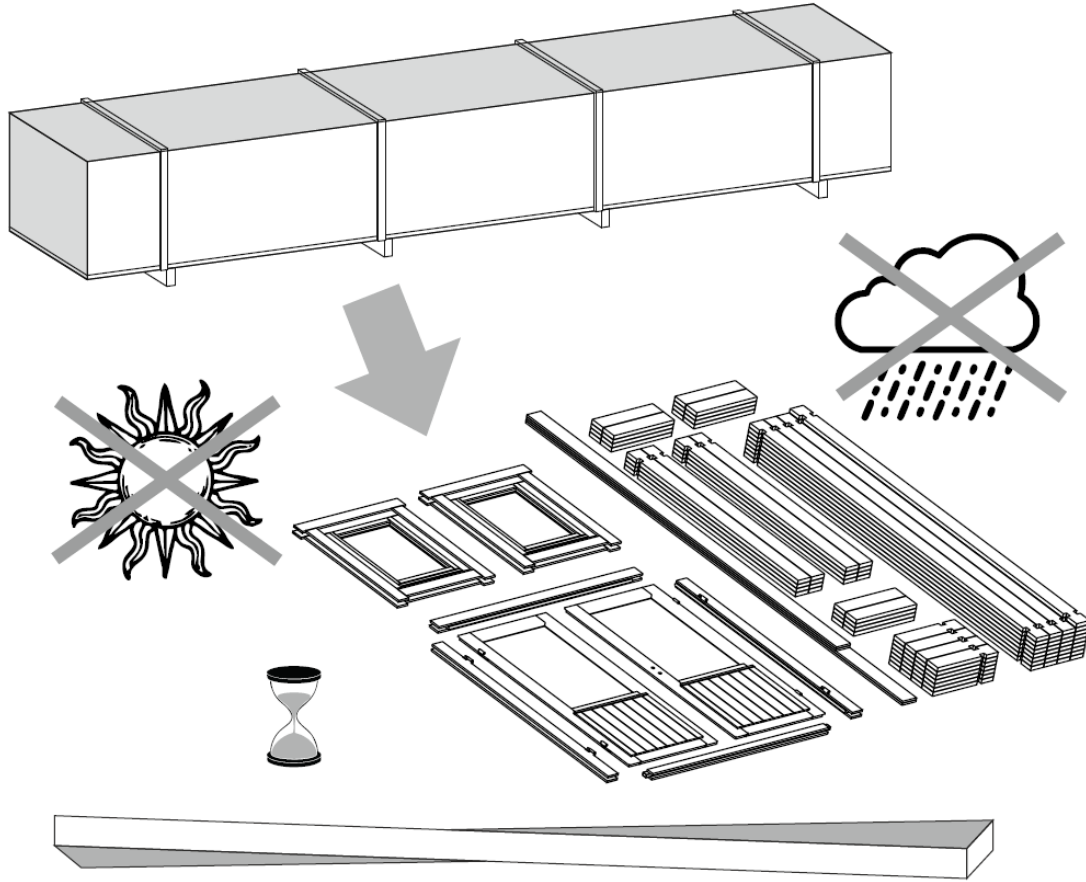

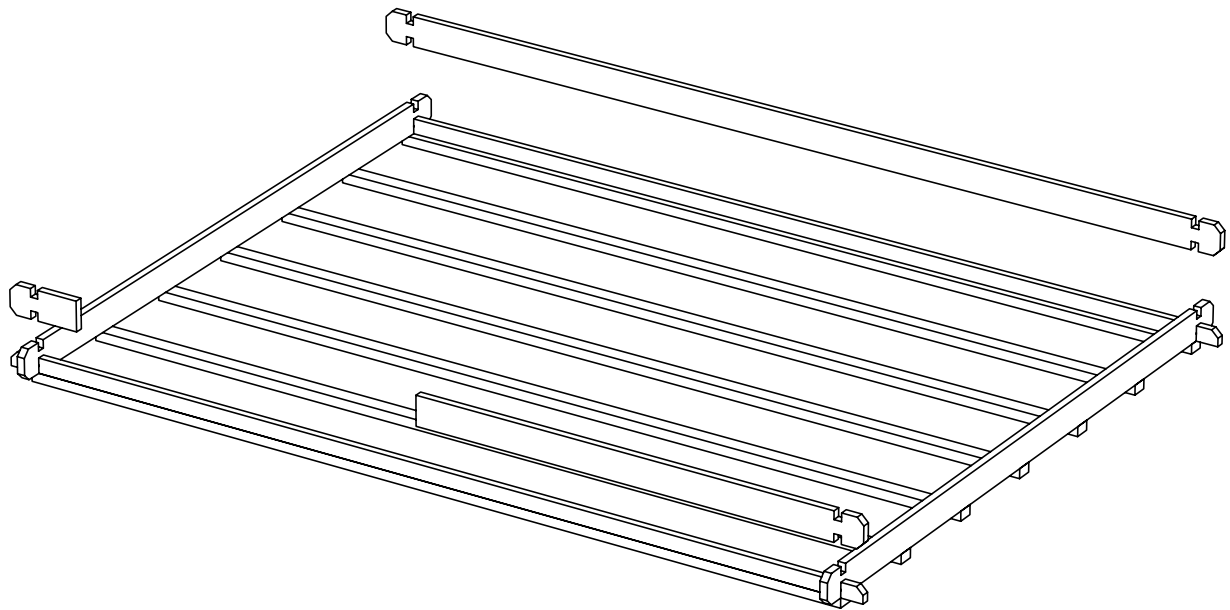
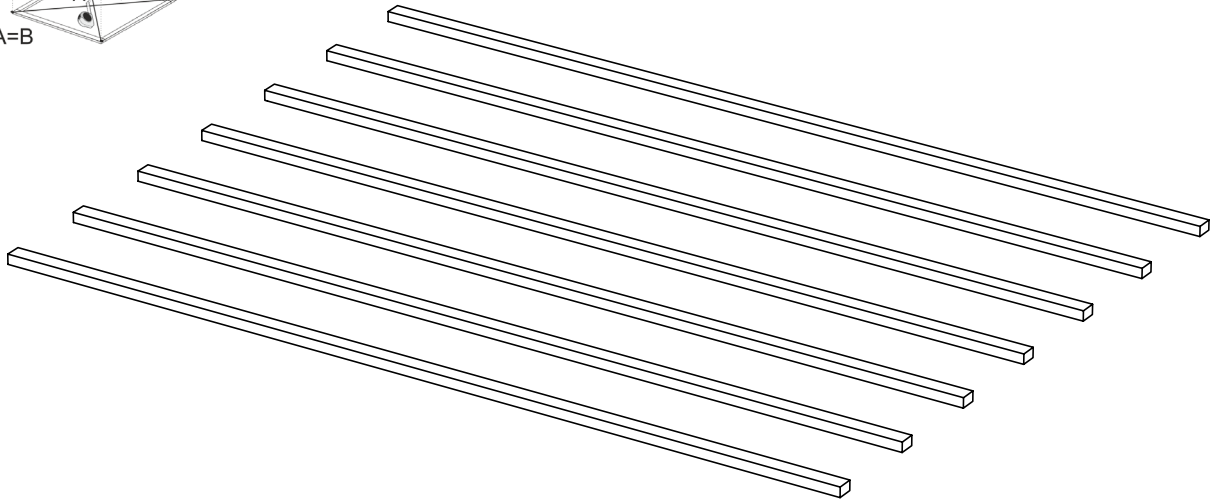
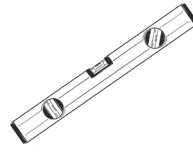
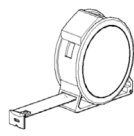
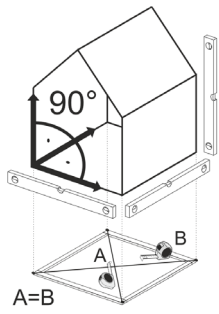

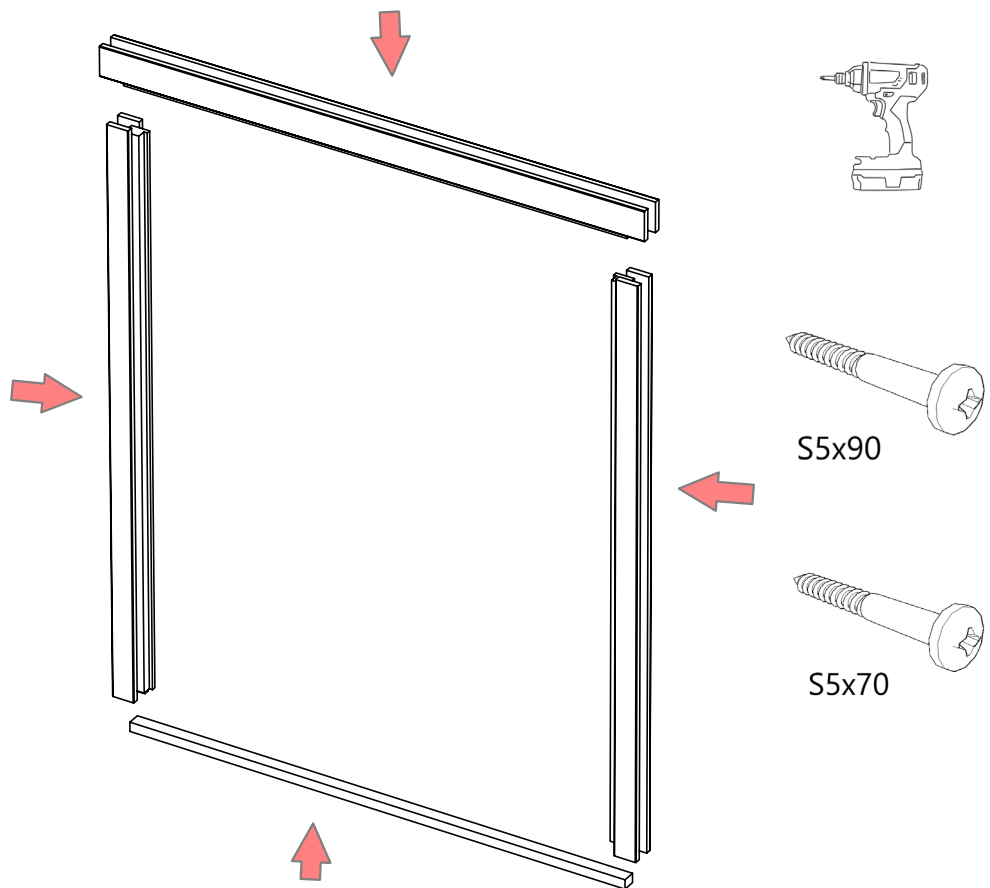
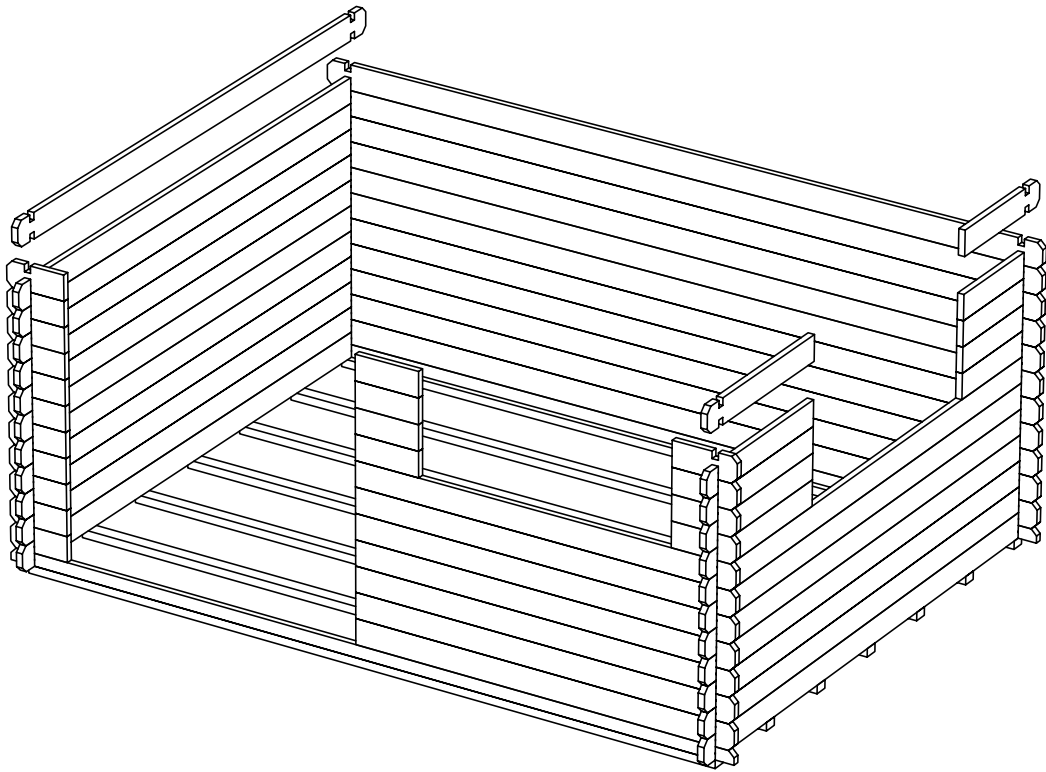

2

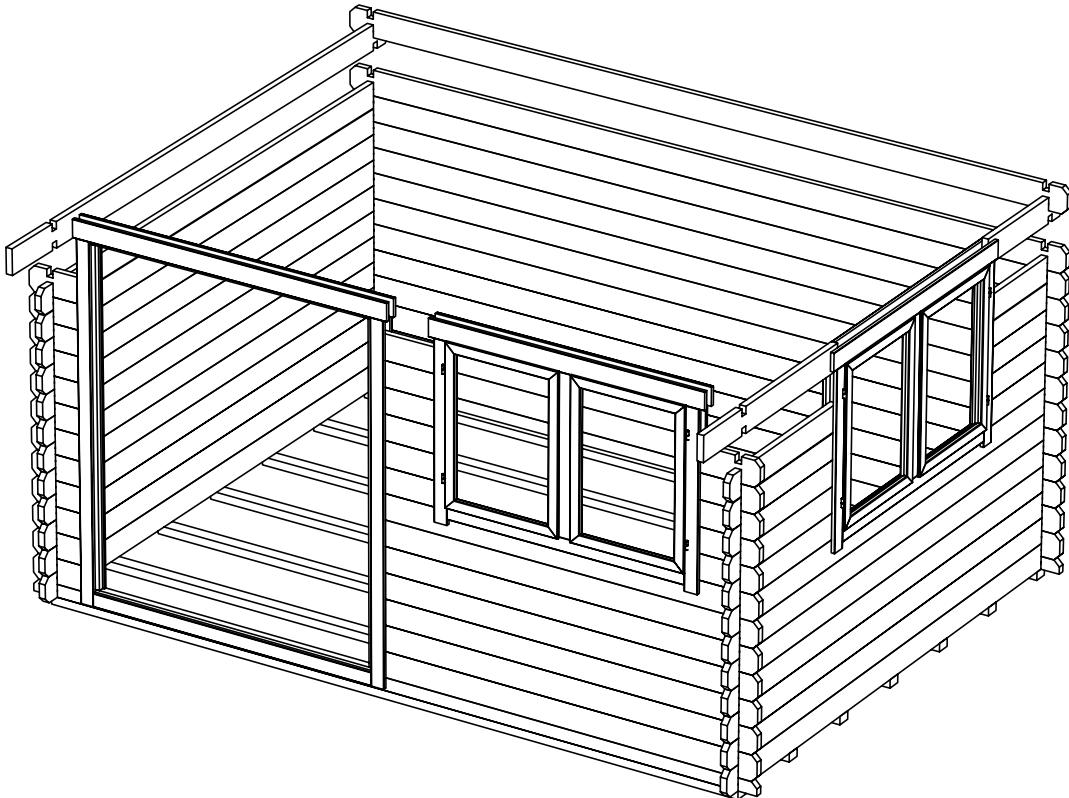
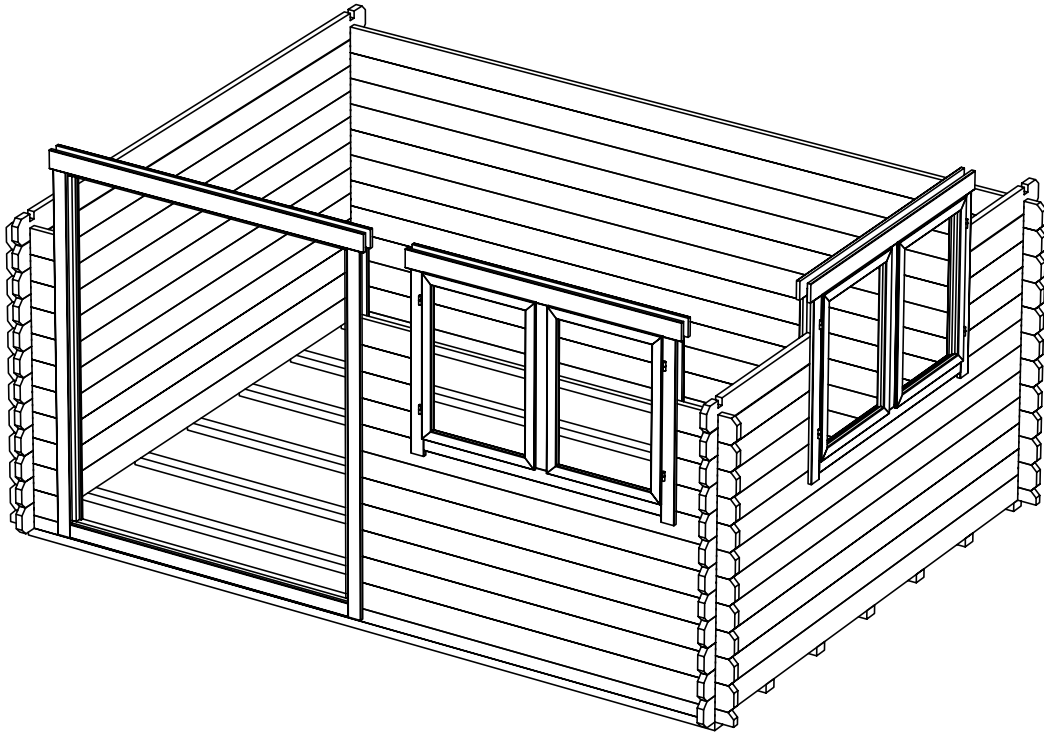

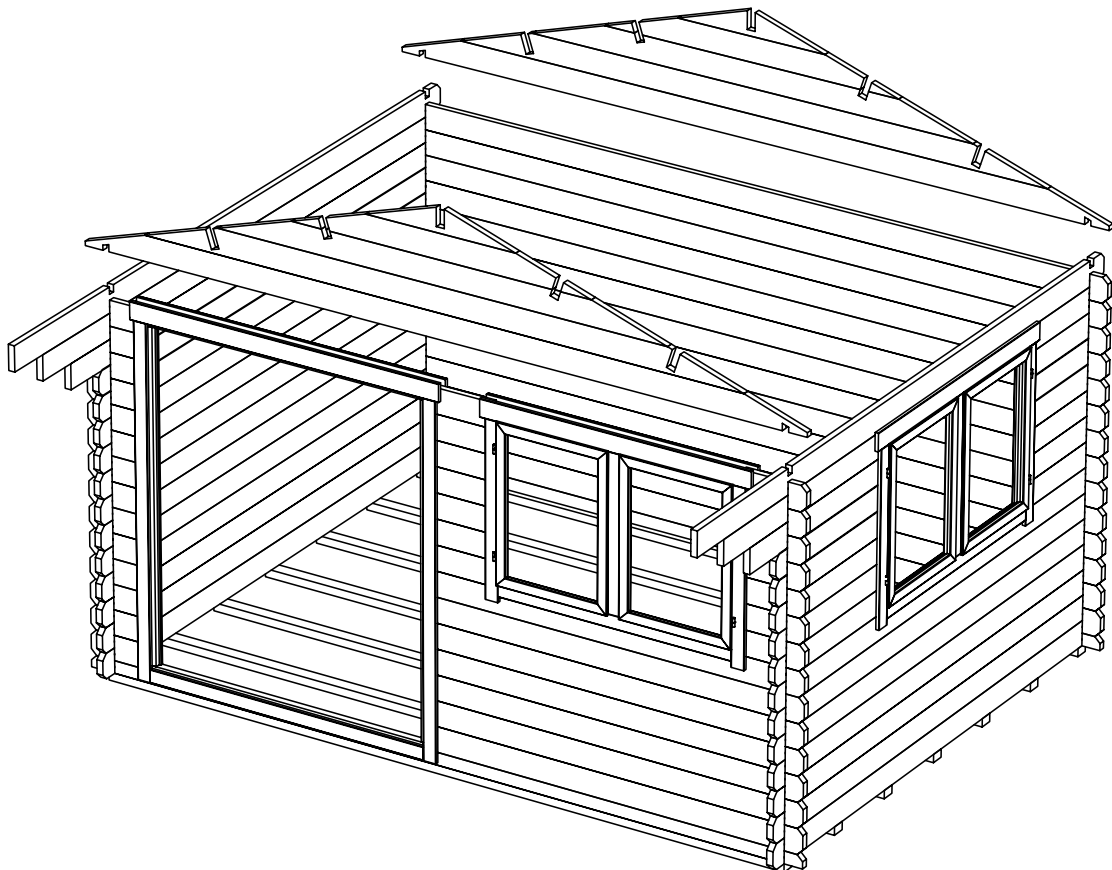
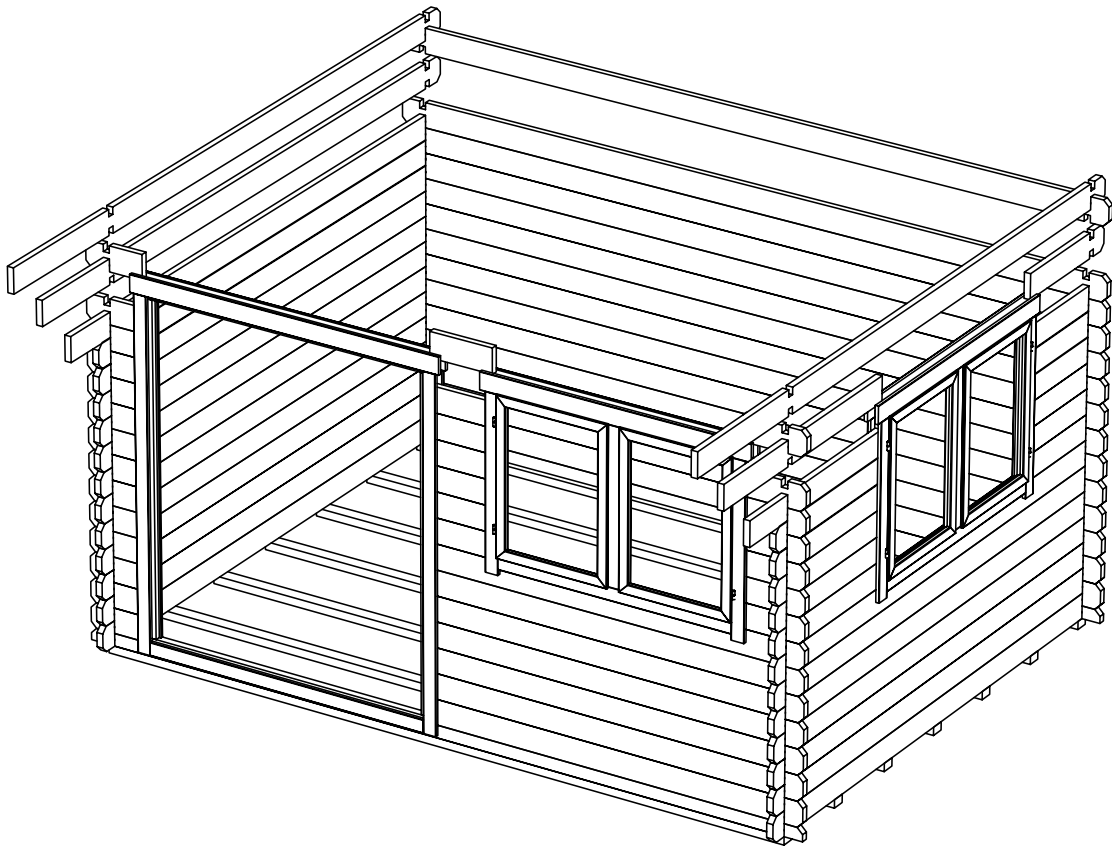

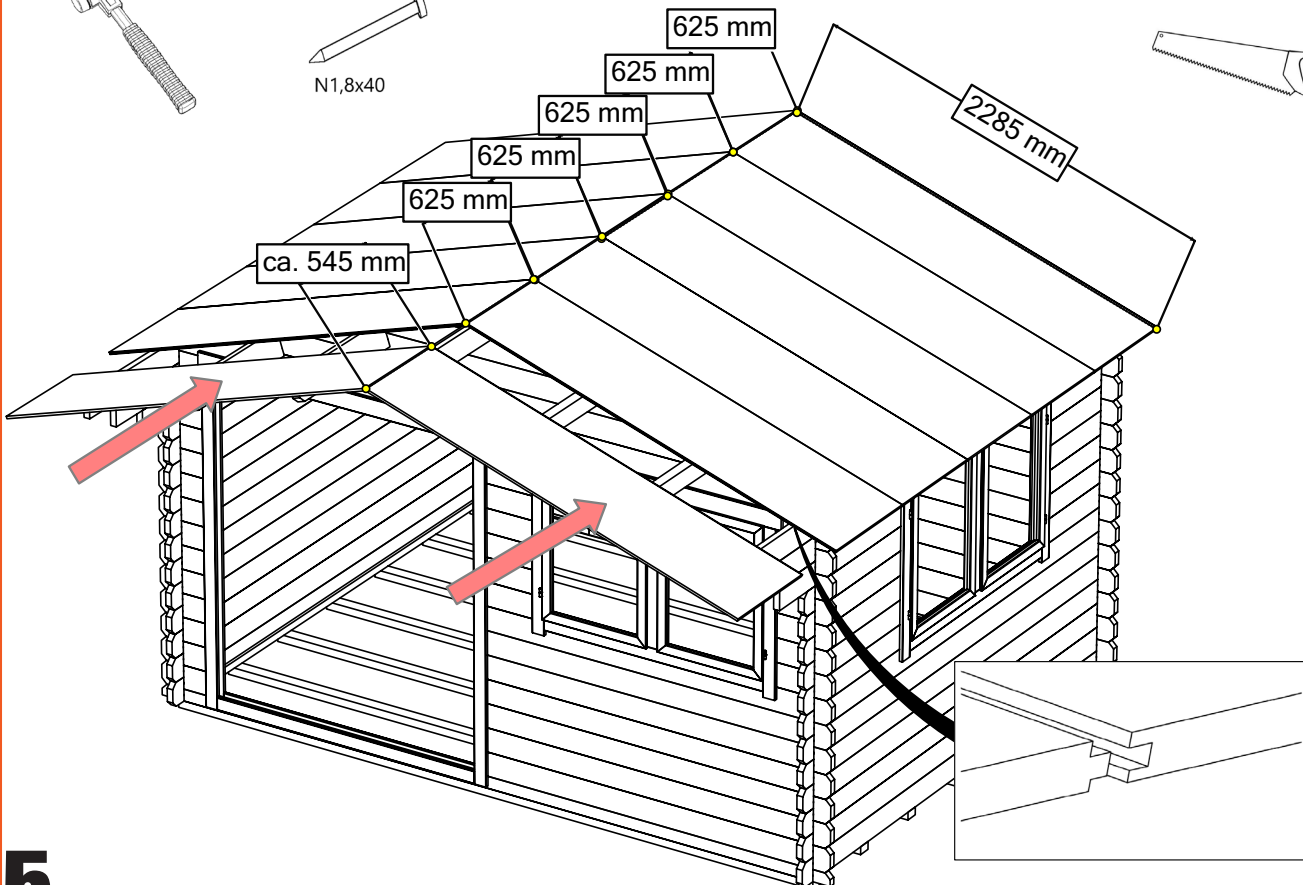
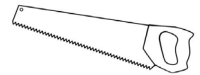
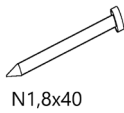
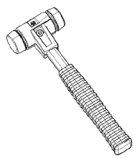
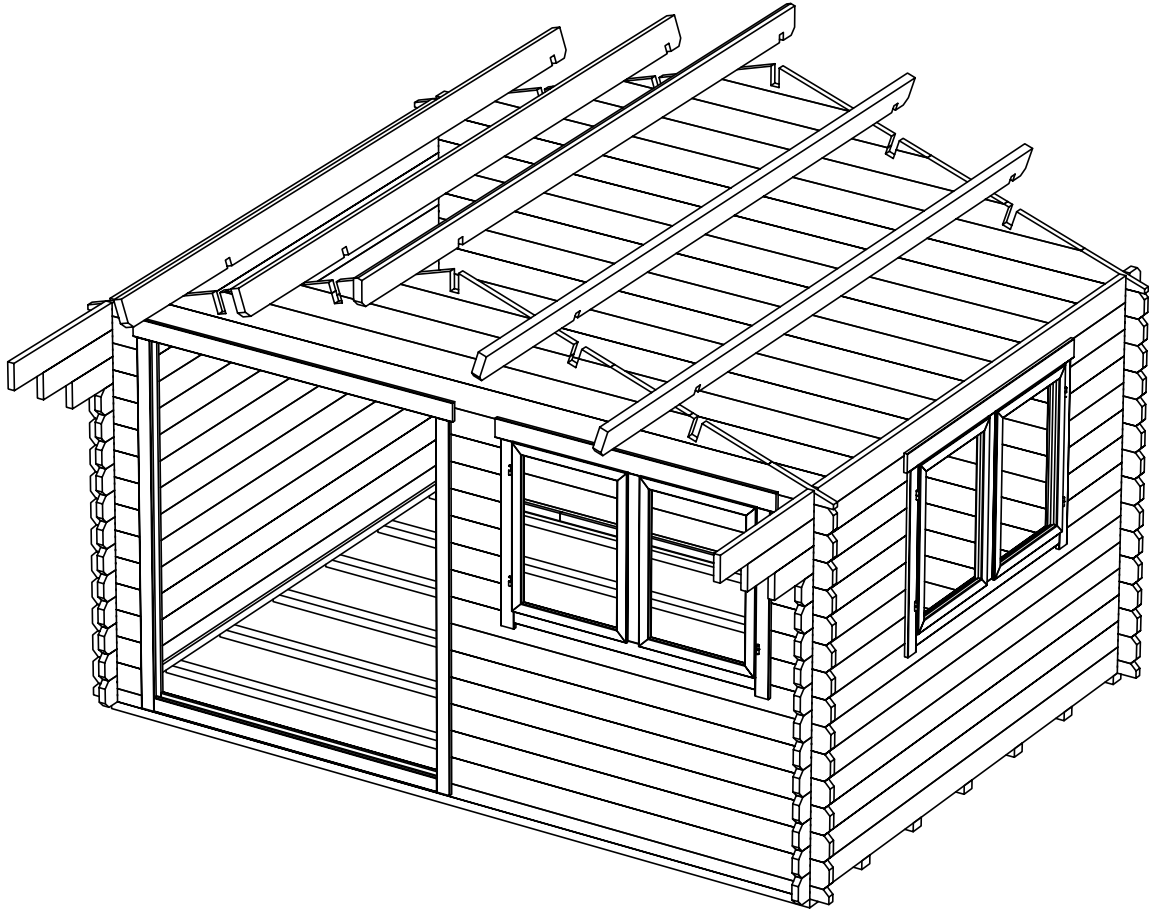

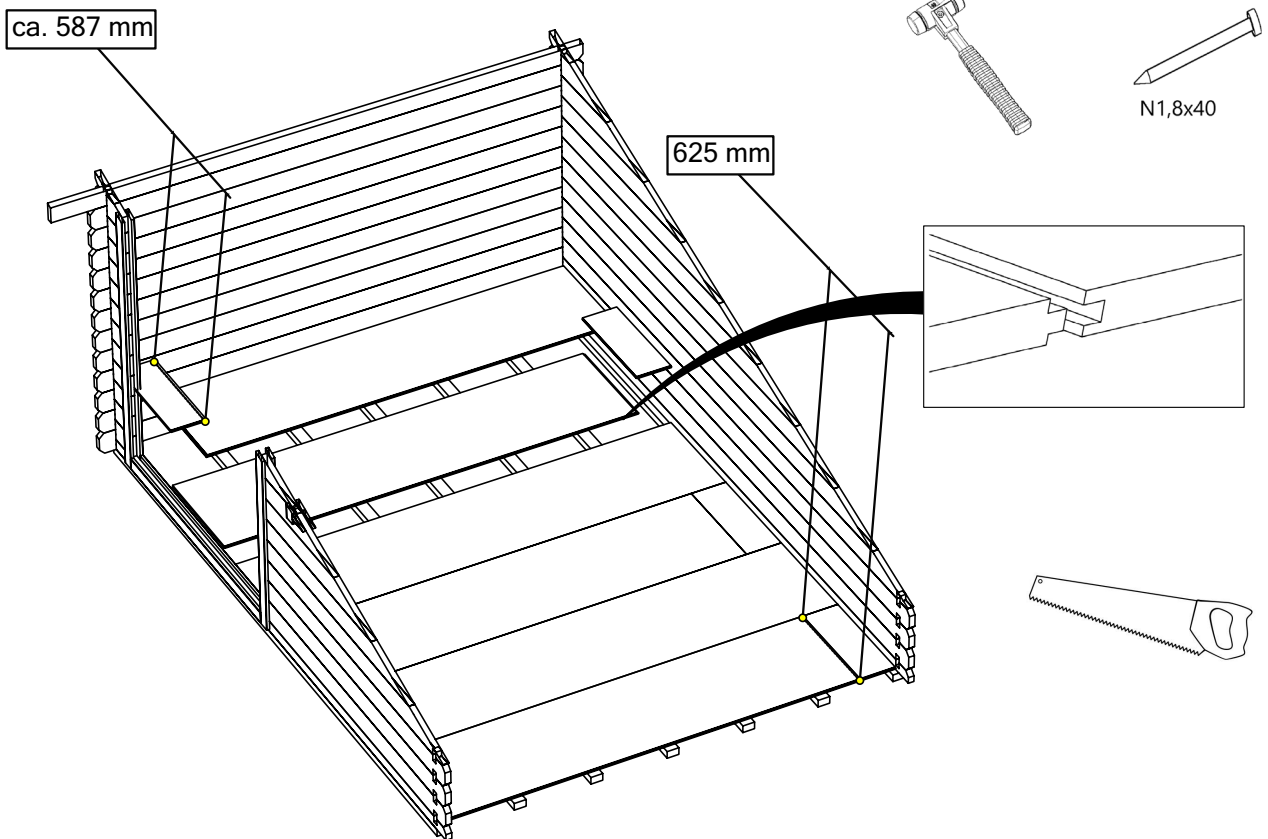
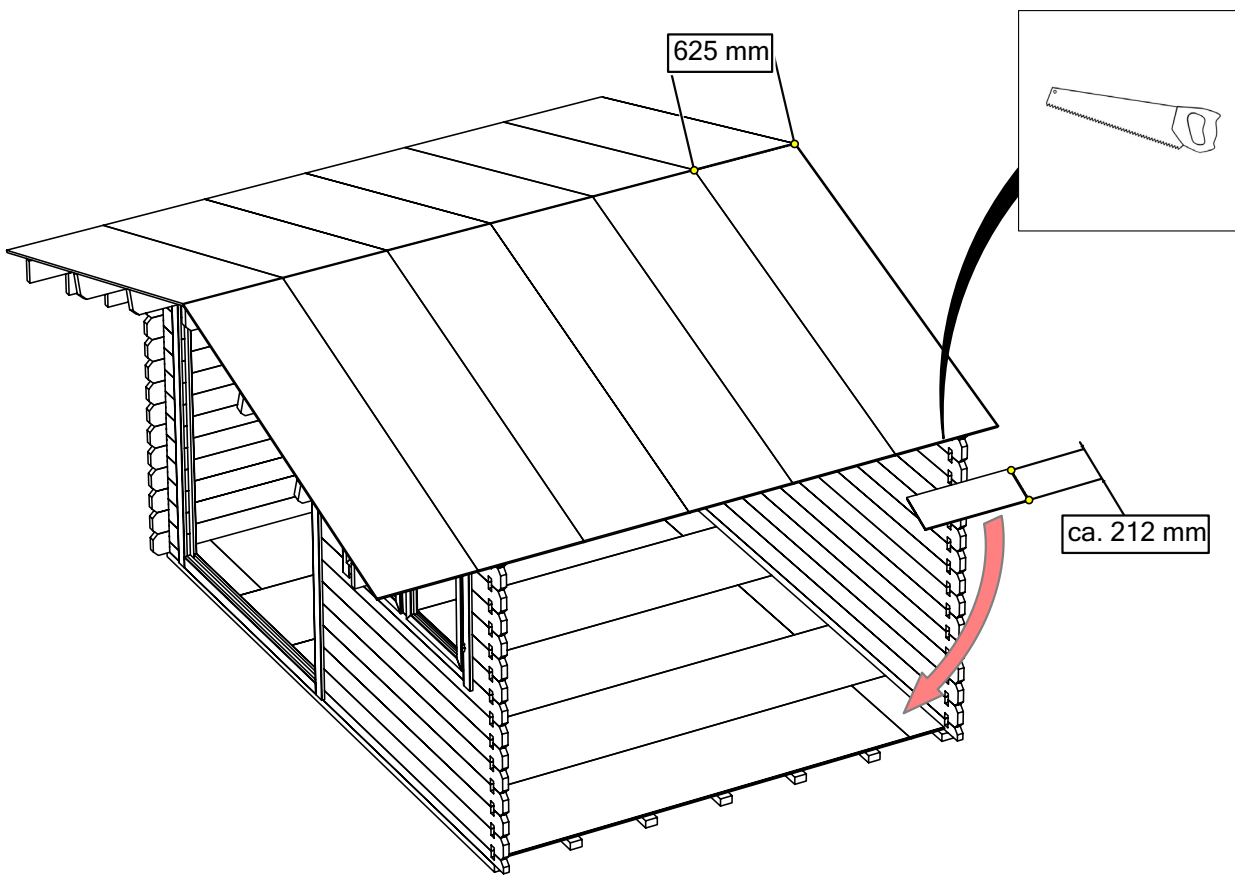



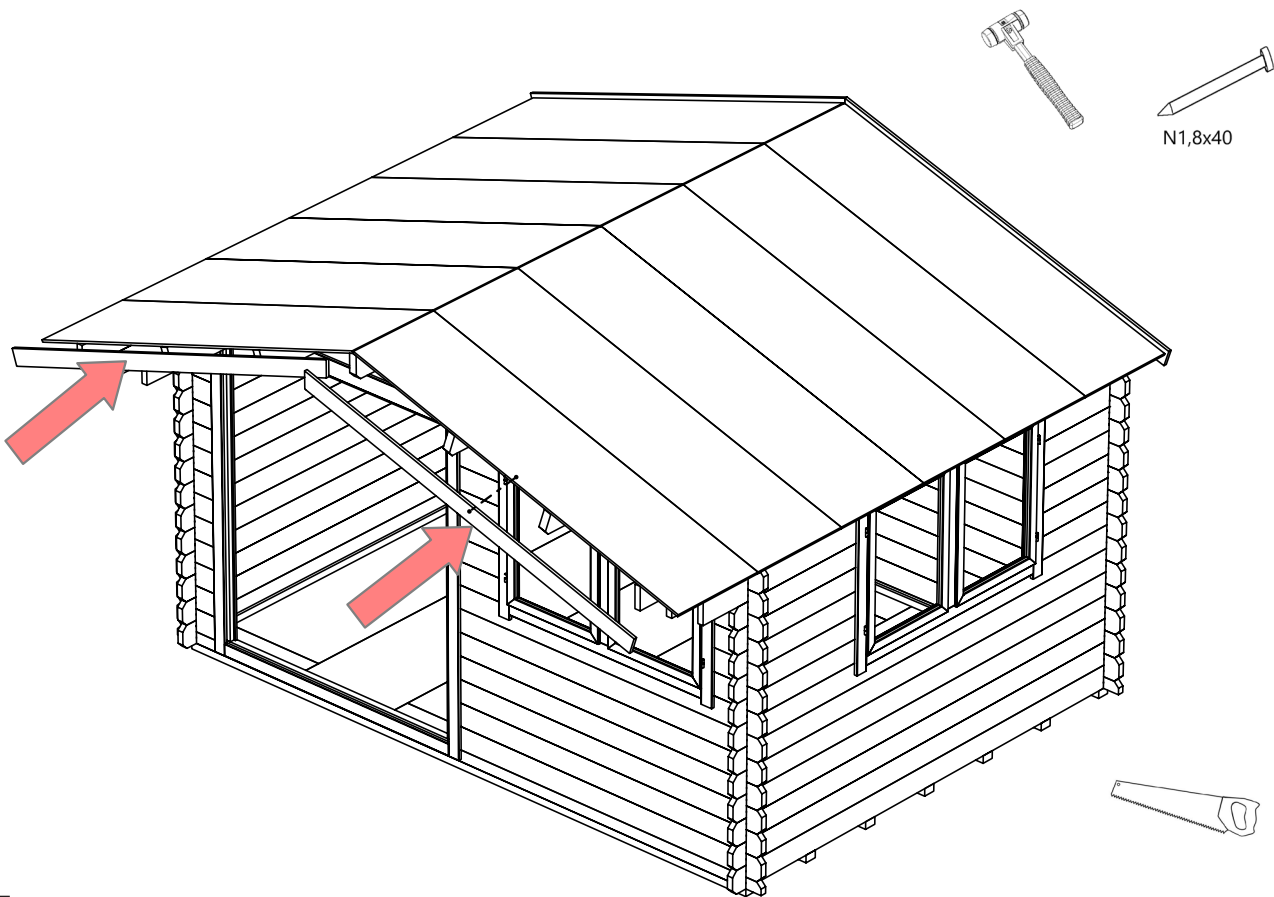
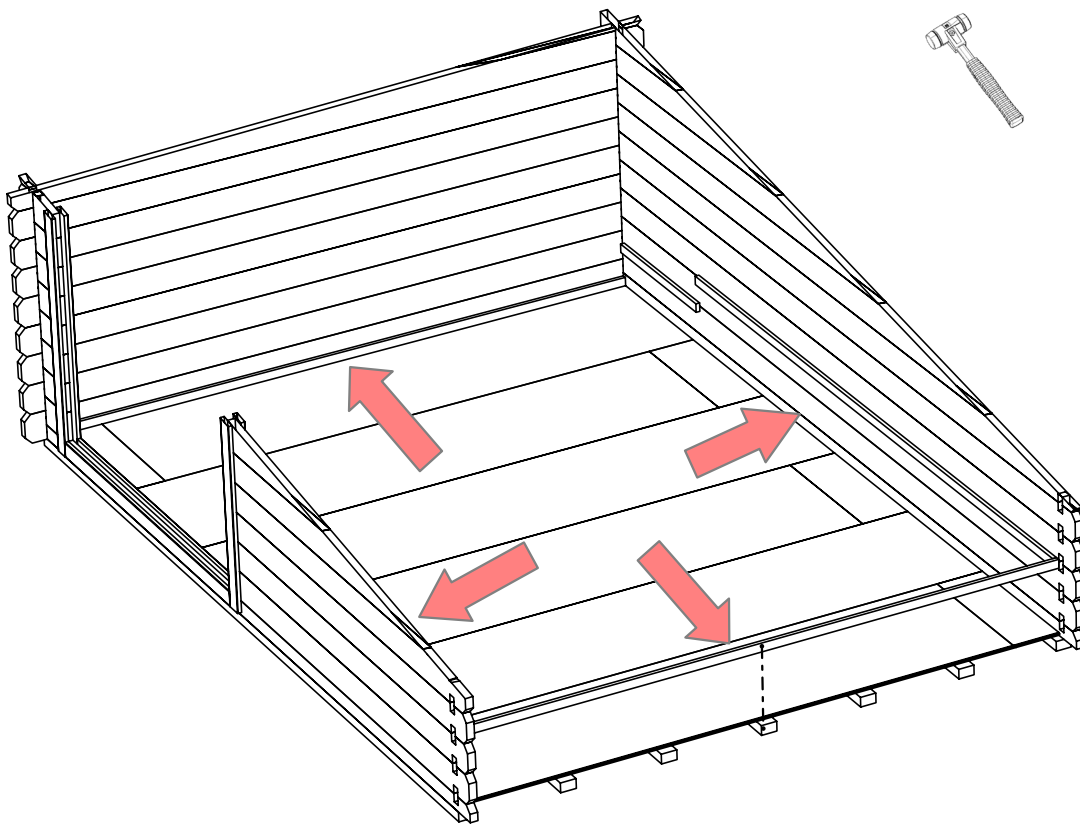

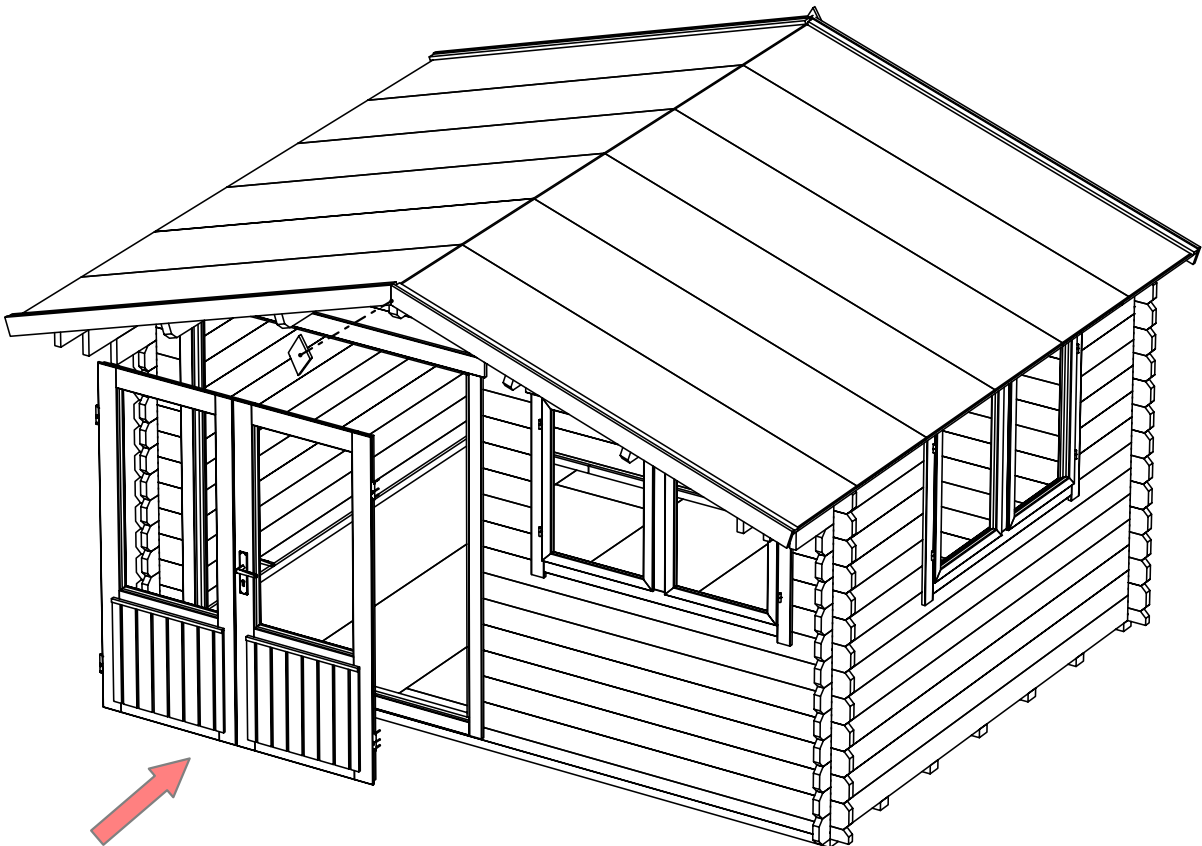
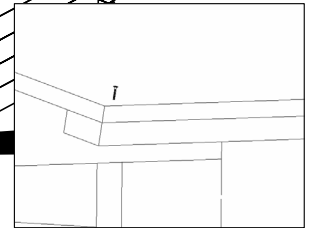
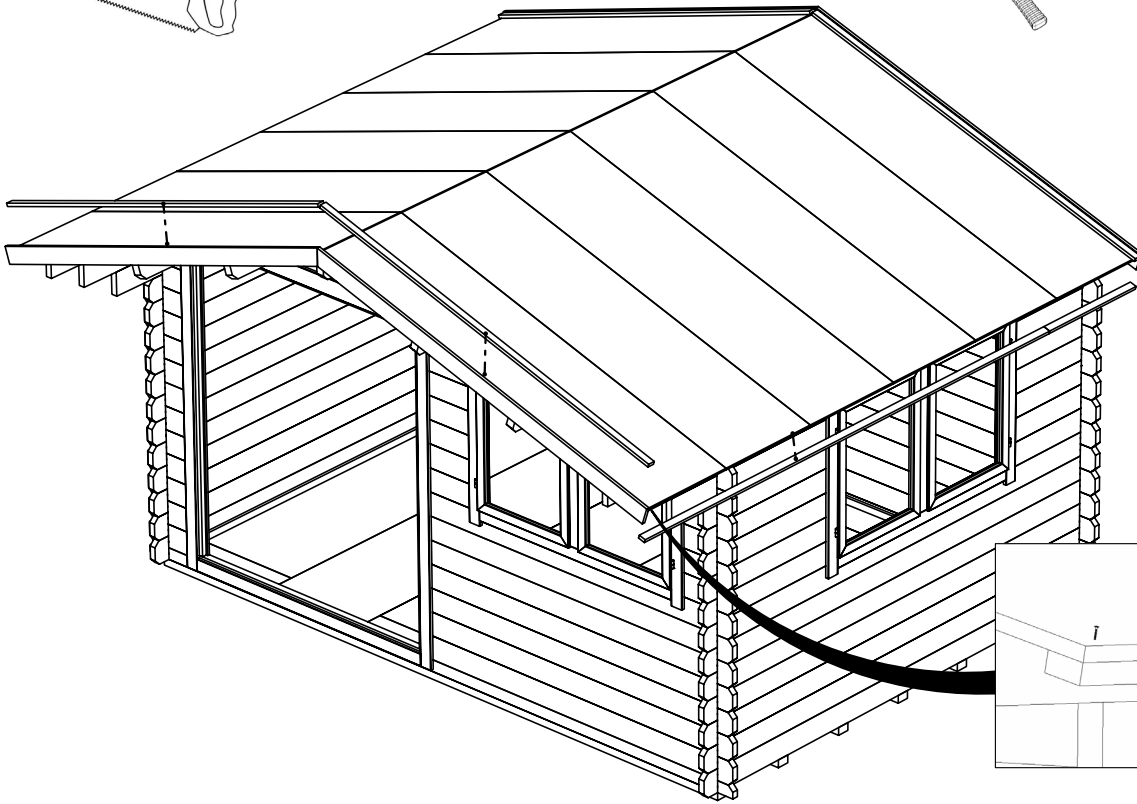
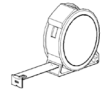
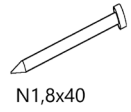
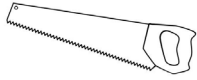

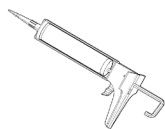
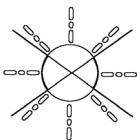
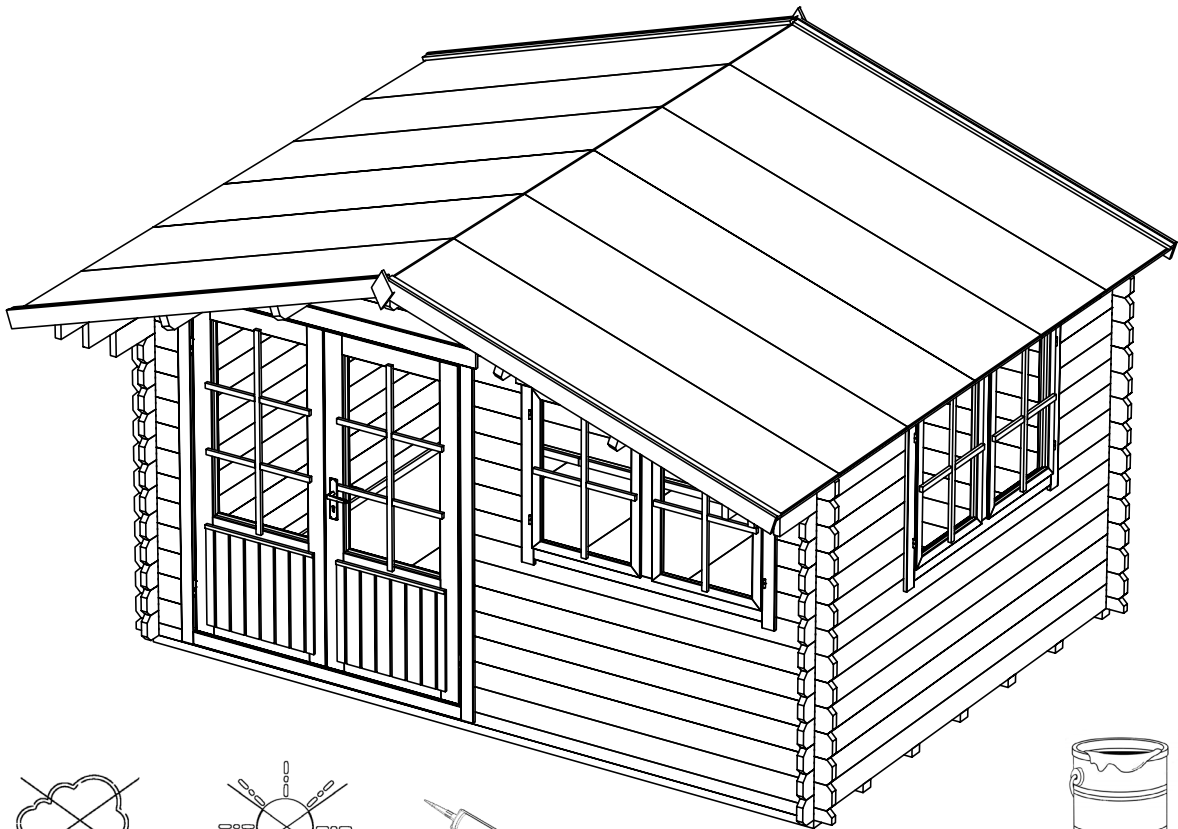
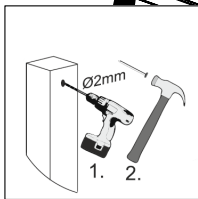
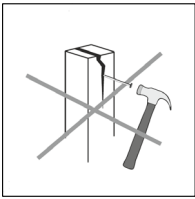
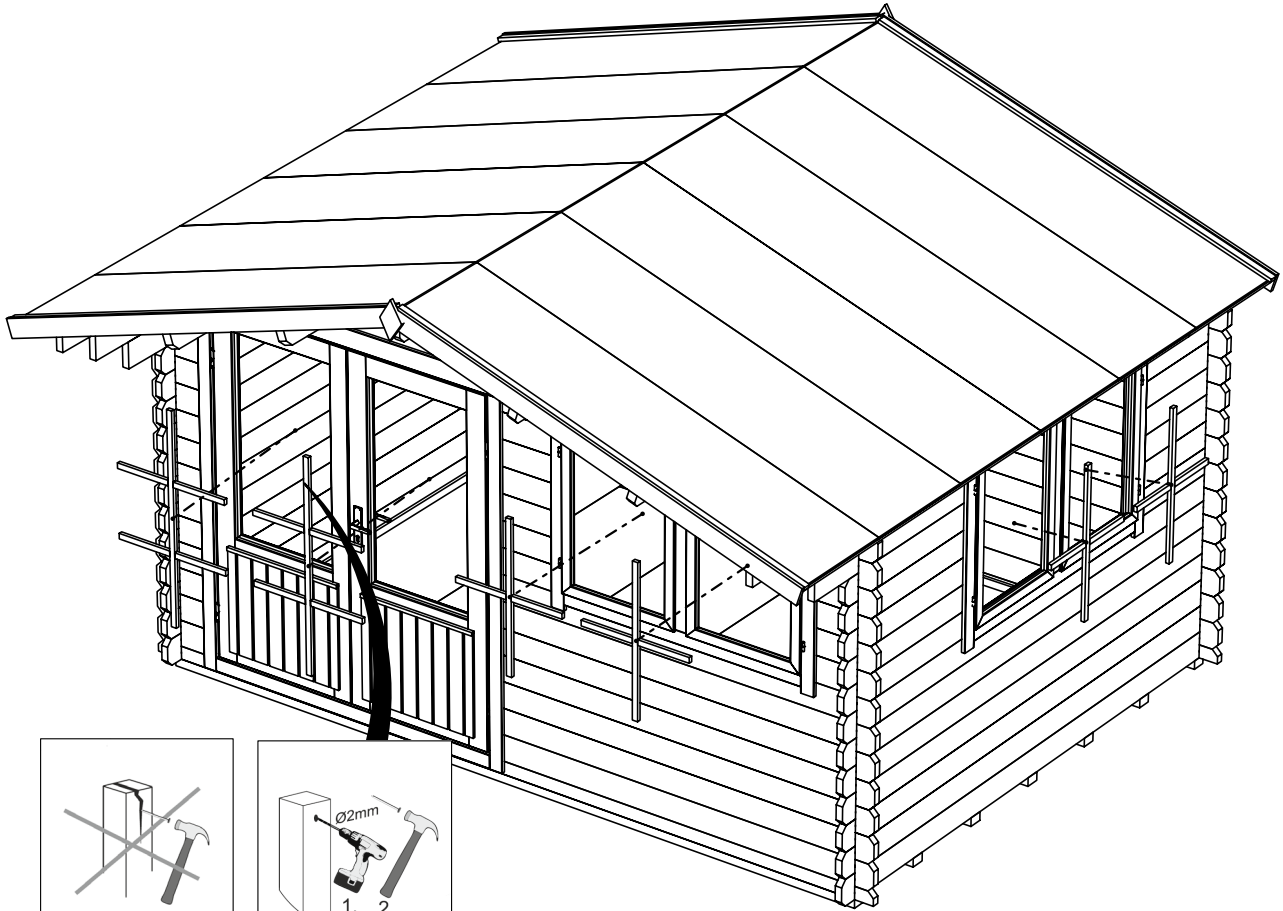



Öffnung/Opening



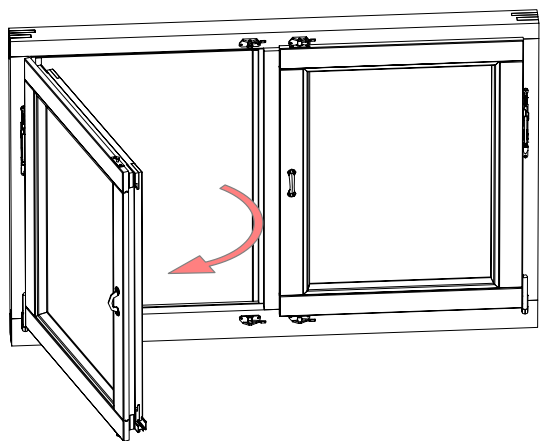
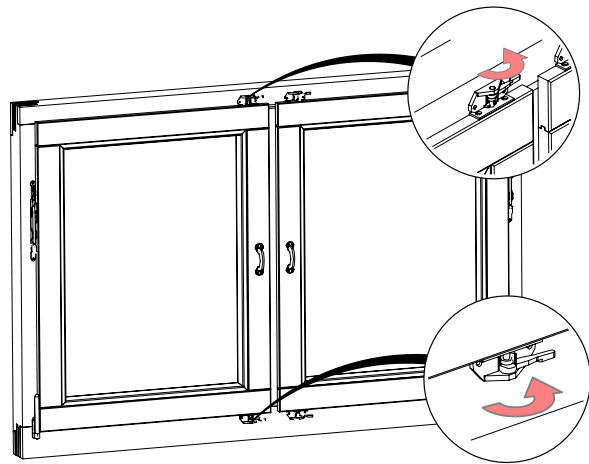

A

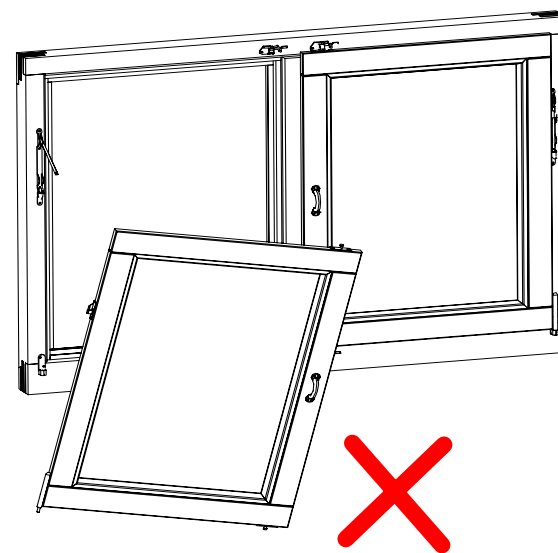
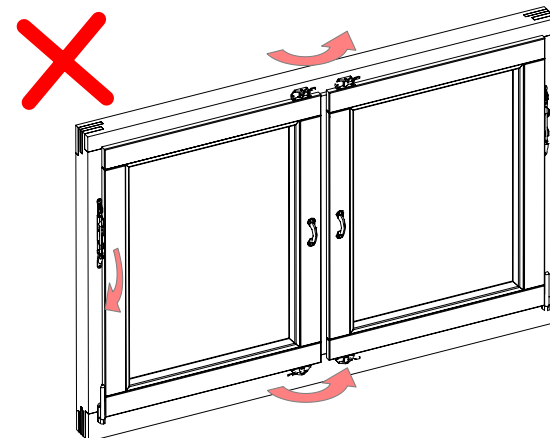
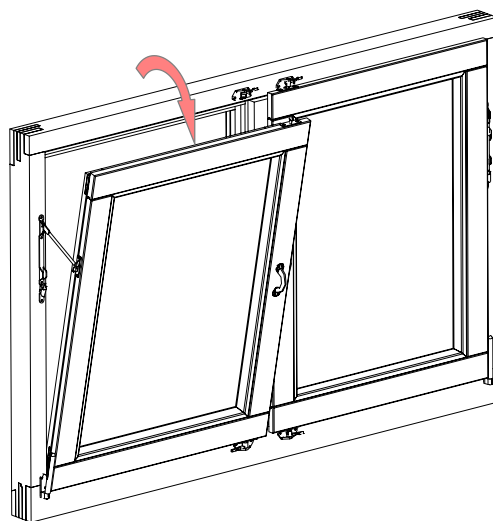
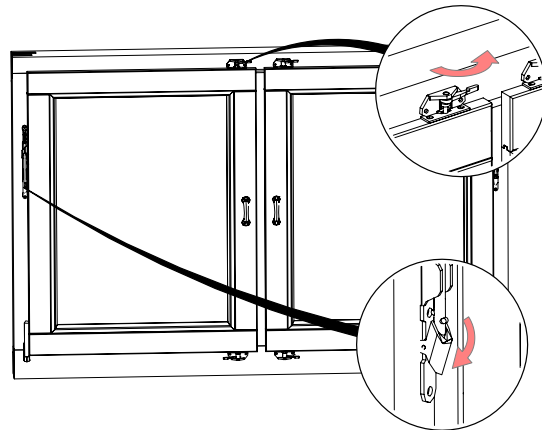

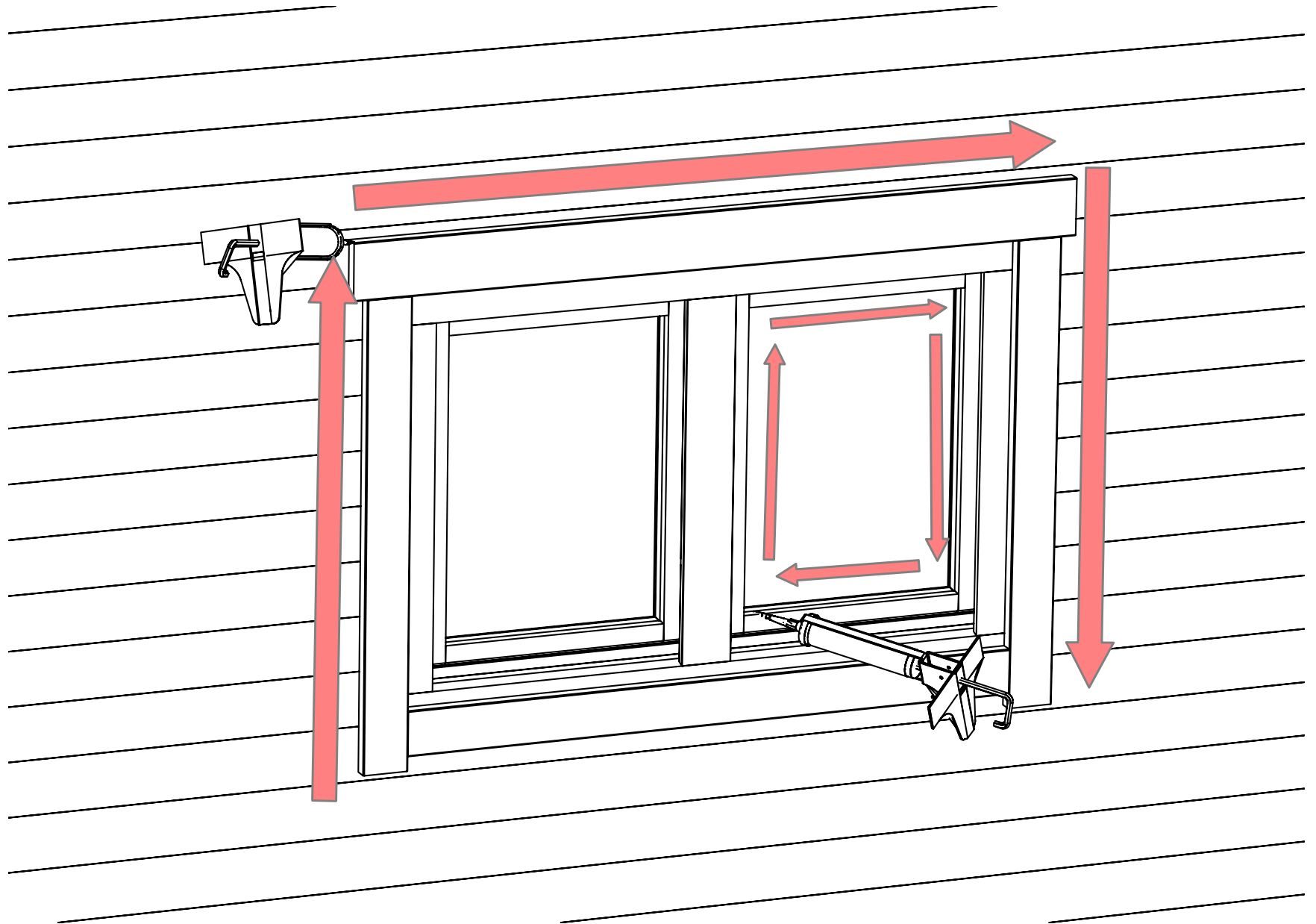
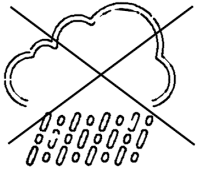

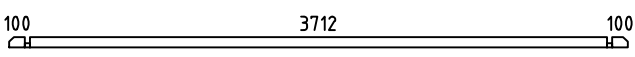

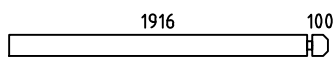

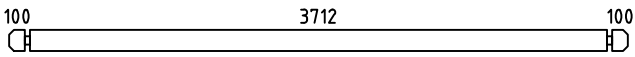
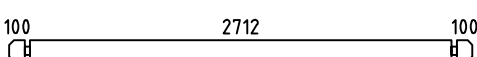
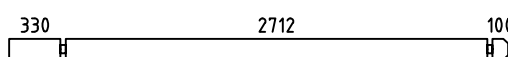
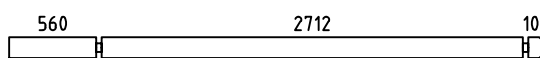
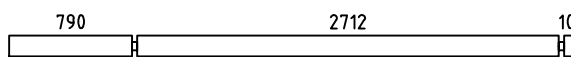
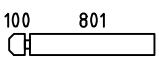
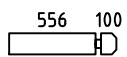
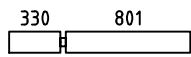
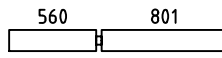
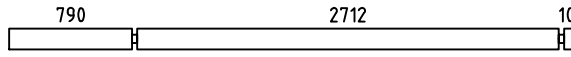
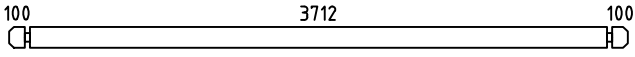
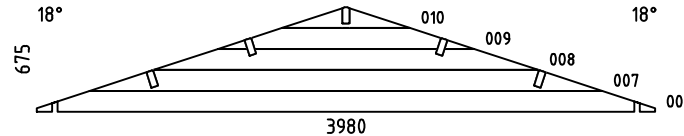
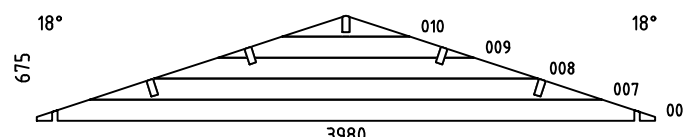
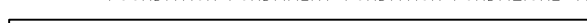
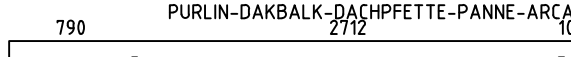
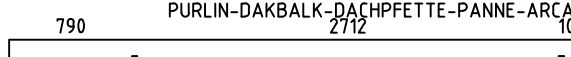
B



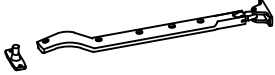

| Pos   | Specification-Spezifikation-Specificatie-Nomenclature-Elementi-Especificacion<br>Gabriel 34 4x3   | Qty      | Profile<br>(mm) | Lenght<br>(mm) |
|-------|---|----------|-----------------|----------------|
| 001   |    | 2        | 34x68           | 3980           |
| 002   | 100186<br>   | 14       | 34x135          | 320            |
| 003   |    | 7        | 34x135          | 2050           |
| 004   |    | 7        | 34x135          | 345            |
| 005   | 211100<br>   | 7        | 34x135          | 345            |
| 011   |    | 14       | 34x135          | 3980           |
| 012   |    | 19       | 34x135          | 2980           |
| 013   |    | 1        | 34x135          | 3210           |
| 014   |    | 1        | 34x135          | 3440           |
| 015   |    | 1        | 34x135          | 3670           |
| 016   |    | 5        | 34x135          | 935            |
| 017   |    | 7        | 34x135          | 690            |
| 018   |    | 1        | 34x135          | 1165           |
| 019   |    | 1        | 34x135          | 1395           |
| 020   |    | 1        | 34x135          | 3670           |
| EXTRA |    | 1        | 34x135          | 3980           |
| W1-1  |   | 1        |                 |                |
| W2-1  |   | 1        |                 |                |
| F1    | FOUNDATION-FUNDAMENT-FONDATION-FONDAZIONE-VIGAS DE CIMENTACIÓN<br> | 7        | 70x44           | 3780           |
| PL1   | PURLIN-DAKBALK-DACHPFETTE-PANNE-ARCA RECCIO-CORREA<br>             | 4        | 44x144          | 3670           |
| PL2   | PURLIN-DAKBALK-DACHPFETTE-PANNE-ARCA RECCIO-CORREA<br>             | 1        | 44x144          | 3670           |
| Model | Gabriel 34 4x3  | Material | Page 1/2        |                |

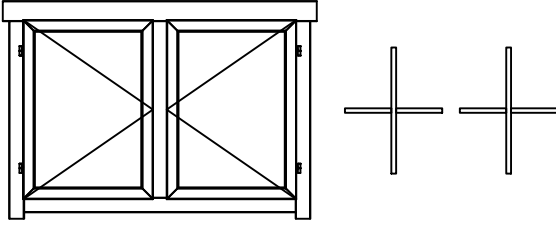
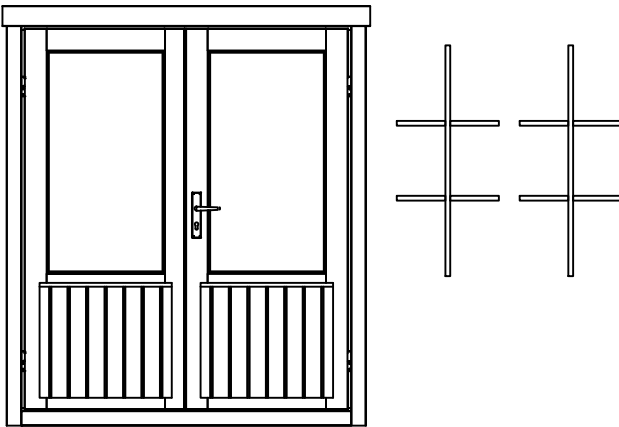
| Pos   | Specification-Spezifikation-Specificatie-Nomenclature-Elementi-Especificacion<br>Gabriel 34 4x3  | Qty      | Profile<br>(mm) | Lenght<br>(mm) |
|-------|--|----------|-----------------|----------------|
| GB-1  | Gable board 95-Giebelblende-Gevelplank-Planche de rive-Tavola di bordo-Tabla de borde                       | 4        | 18x95           | 2280           |
| GB-2  | Gable board 95-Giebelblende-Gevelplank-Planche de rive-Tavola di bordo-Tabla de borde                       | 2        | 18x95           | 3670           |
|       | OSB   | 18       | 625x2500        | 12mm           |
| RL-1  | Roofing lath 3000-Giebelleiste-Gevellijst-Latte de rive-Listello di bordo>Listones de borde                 | 6        | 18x40           | 18rmt.         |
|       | Double door kit-Doppeltür satz-Dubbele deur set-Kit double porte-Kit porta-Kit para puerta                   | 1        |                 |                |
|       | Window stay-Fensterfeststeller-Raamuitzetter-Limiteur d'ouverture fenêtre-Vento bretelle-Soporte de ventana  | 2        |                 |                |
| FLB-1 | Floor beading 3000-Fussbodenleiste-Plinten-Moulure de finition-Listello pavimento-Liston de suelo           | 5        | 18x40           | 15rmt.         |
|       | Nail 1.8x40-Nagel-Spijker-Clou-Chiodo-Clavo   | 270      | 1.8x40          |                |
|       | WINDOW 1345x900<br>DW0-4 TVP 1345x900-34<br>  | 2        |                 |                |
|       | DOOR 1600x1850<br>DD06-6 H 1600x1850-28<br>  | 1        |                 |                |
|       |  |          |                 |                |
|       |  |          |                 |                |
|       |  |          |                 |                |
|       |  |          |                 |                |
|       |  |          |                 |                |
| Model | Gabriel 34 4x3   | Material | Page            | 2/2            |



H = 1.600 m  
TOTAL: 10.07 m<sup>2</sup>

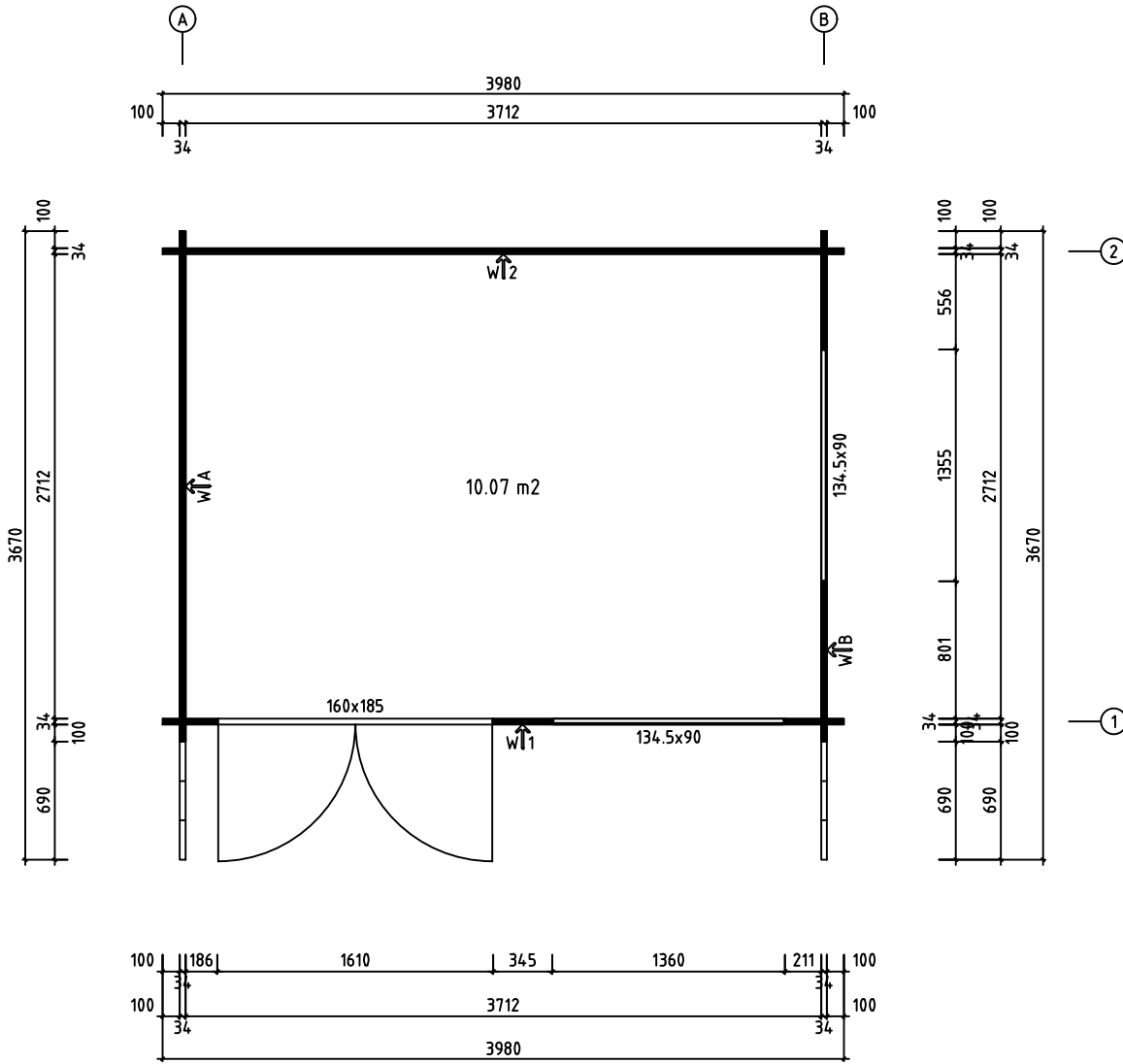

|       |                |          |                    |                 |
|-------|----------------|----------|--------------------|-----------------|
| Model | Gabriel 34 4x3 | Drawing  | PLAN               | Page            |
|       |                | Drawn by | J.S                | Material 34x135 |
|       |                | Date     | 08.05.2024         | Scale 1:30      |
|       |                | File     | Gabriel 34 4x3.dwg |                 |

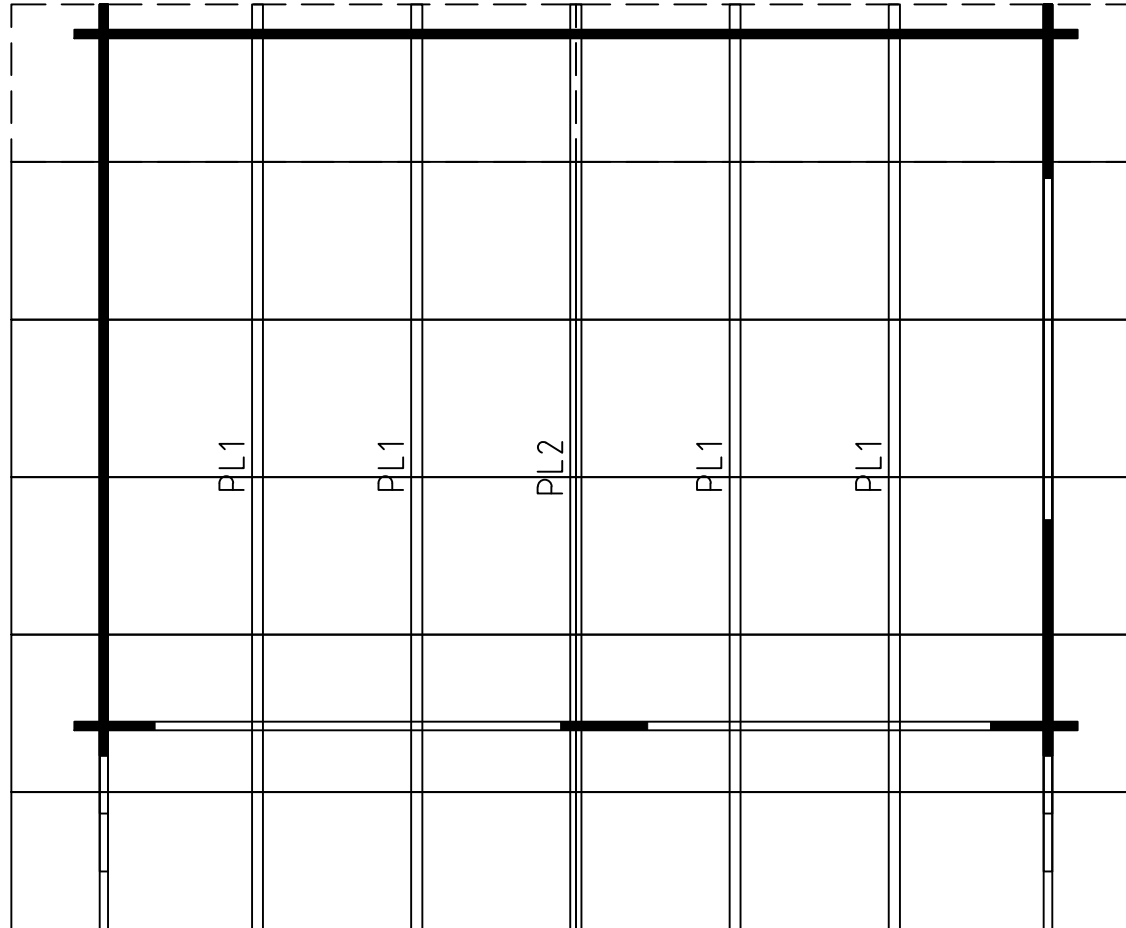

0 0.5m 1.0m 2.0m

|   |                |            |          |                    |       |
|---|----------------|------------|----------|--------------------|-------|
| Model   | Gabriel 34 4x3 |            | Drawing  | ROOF               | Page  |
|  | Drawn by       | J.S        | Material | 34x135             | Scale |
|   | Date           | 08.05.2024 | File     | Gabriel 34 4x3.dwg |       |

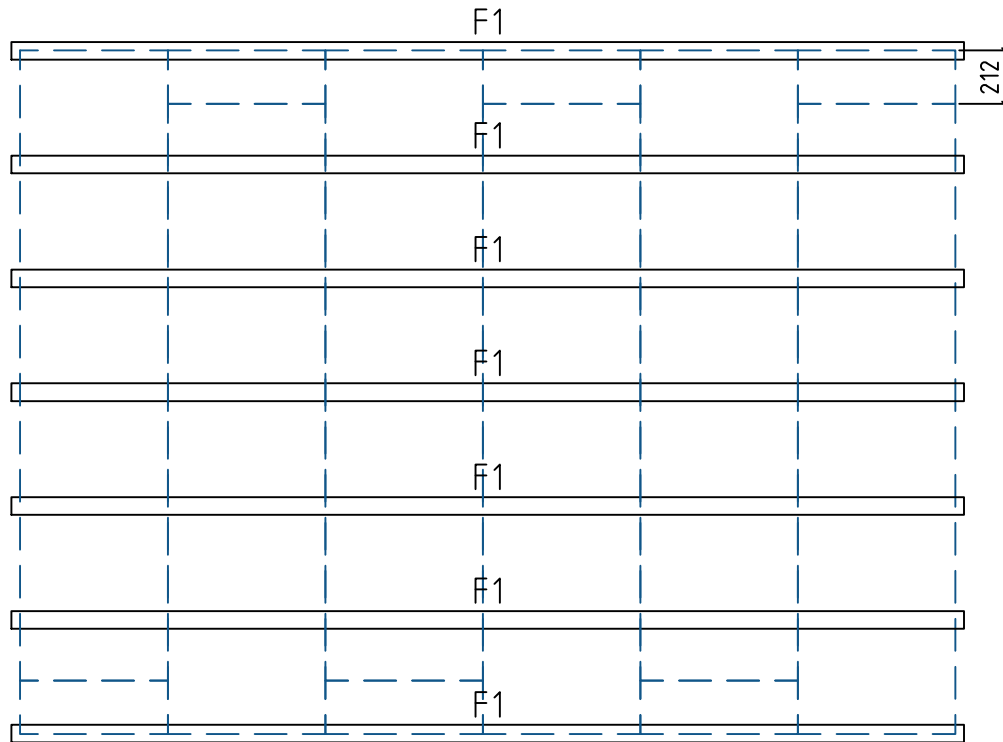

NOTE!  
Roof osb ends to be used on the floor.

0 0.5m 1.0m 2.0m

|   |                |            |            |                    |
|---|----------------|------------|------------|--------------------|
| Model   | Gabriel 34 4x3 | Drawing    | FOUNDATION | Page               |
|  | Drawn by       | J.S        | Material   | 34x135             |
|   | Date           | 08.05.2024 | File       | Gabriel 34 4x3.dwg |
|   |                |            | Scale      | 1:30               |

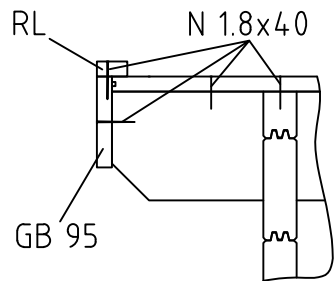

WALL A ↑

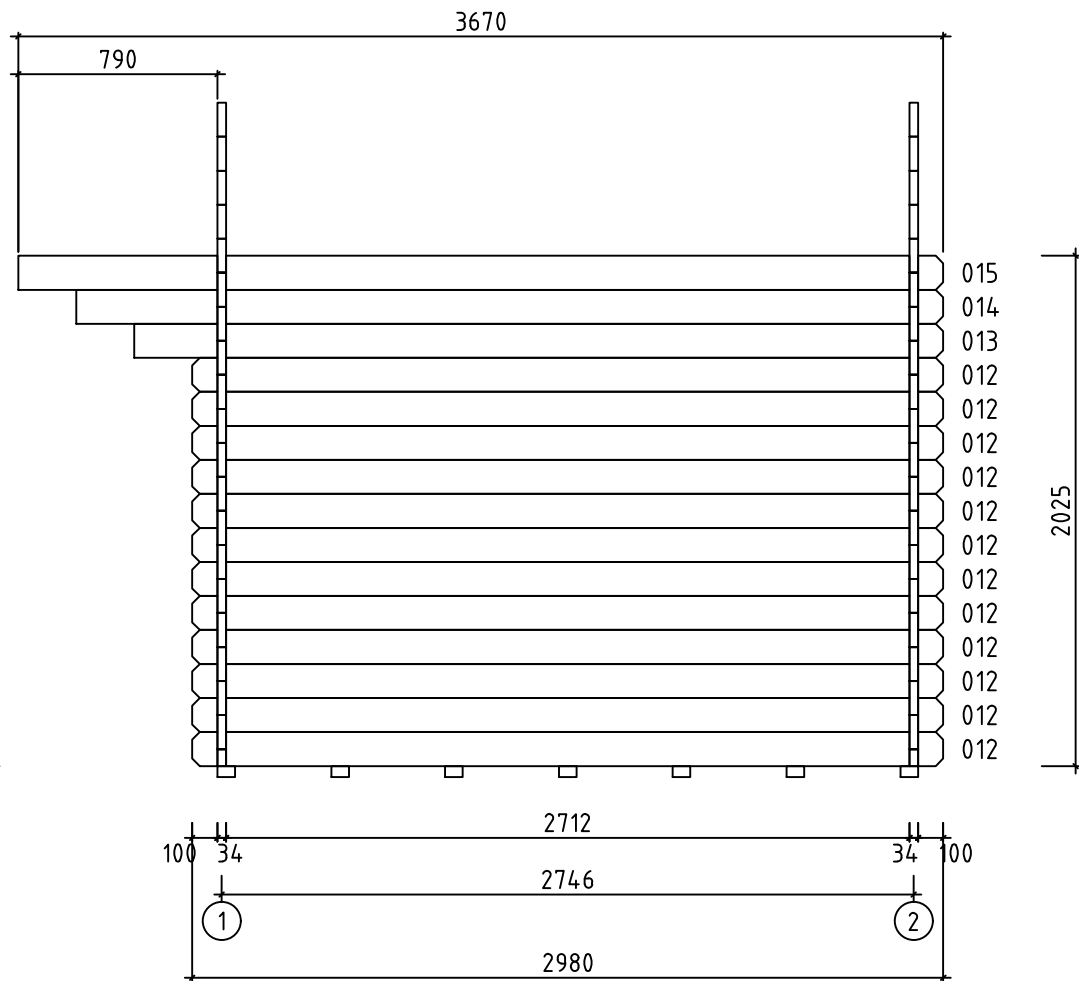

0 0.5m 1.0m 2.0m

|   |                |            |          |                    |       |      |
|---|----------------|------------|----------|--------------------|-------|------|
| Model   | Gabriel 34 4x3 | Drawing    | WALL A   | Page               | 3     |      |
|  | Drawn by       | J.S        | Material | 3.4x13.5           | Scale | 1:30 |
|   | Date           | 08.05.2024 | File     | Gabriel 34 4x3.dwg |       |      |

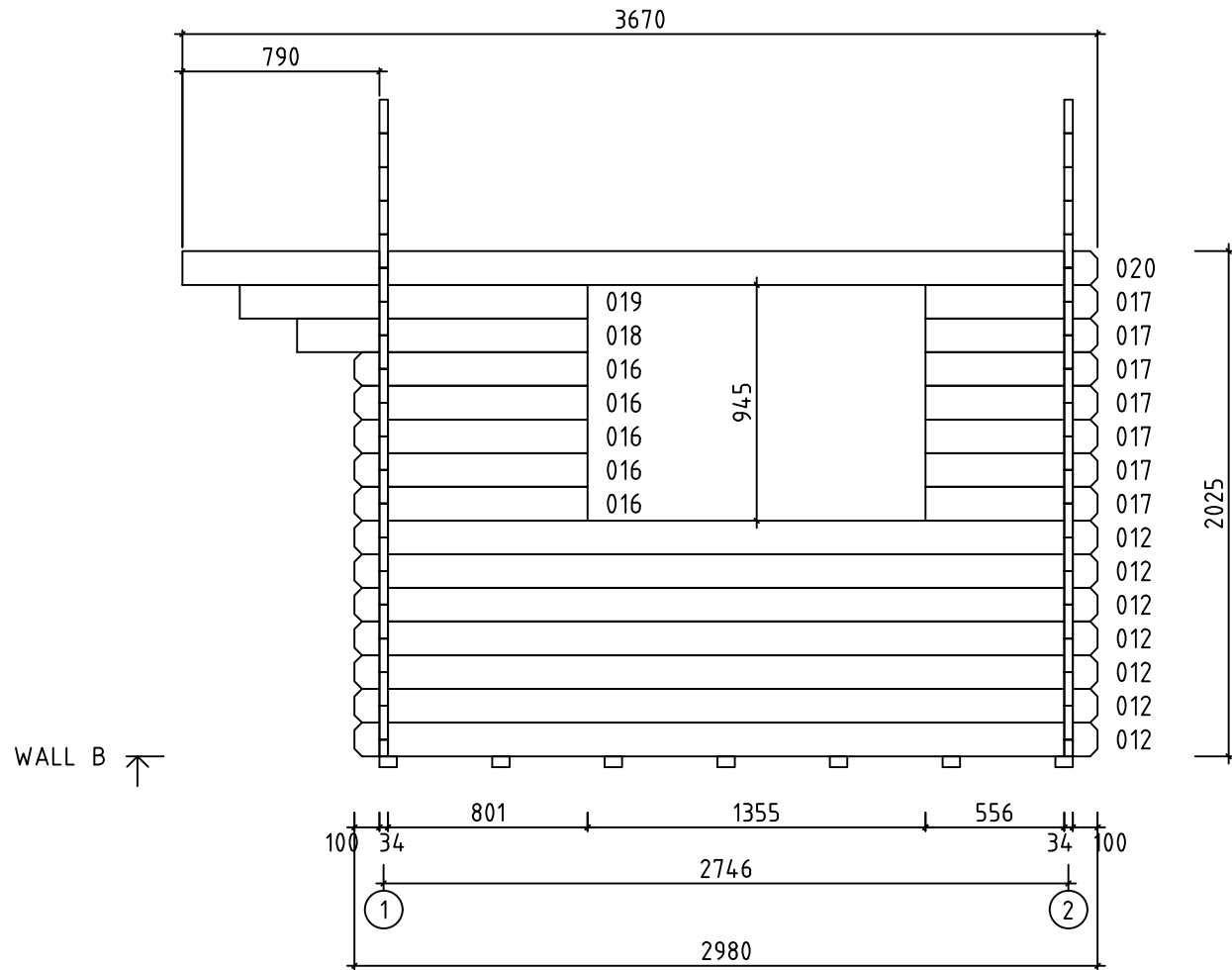

0 0.5m 1.0m 2.0m

|   |                |            |          |                    |       |      |
|---|----------------|------------|----------|--------------------|-------|------|
| Model   | Gabriel 34 4x3 | Drawing    | WALL B   | Page               | 4     |      |
|  | Drawn by       | J.S        | Material | 3.4x13.5           | Scale | 1:30 |
|   | Date           | 08.05.2024 | File     | Gabriel 34 4x3.dwg |       |      |

N 1.8x40

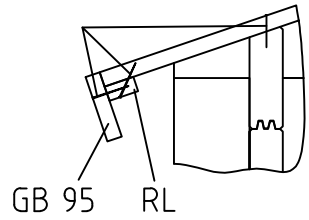

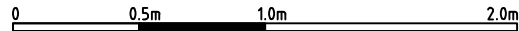
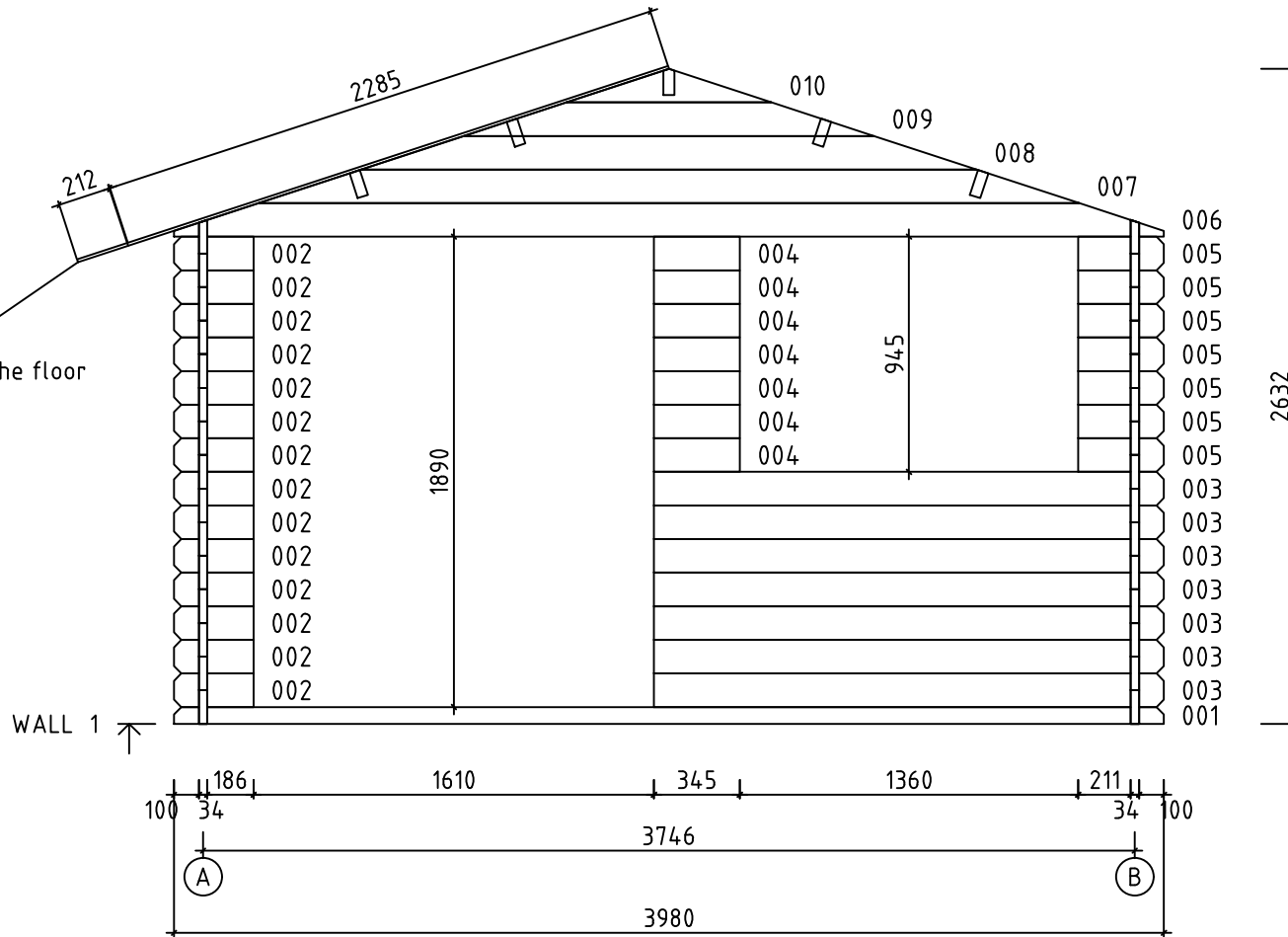

GB 95 RL

Use the cut ends to cover the floor

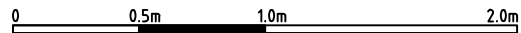
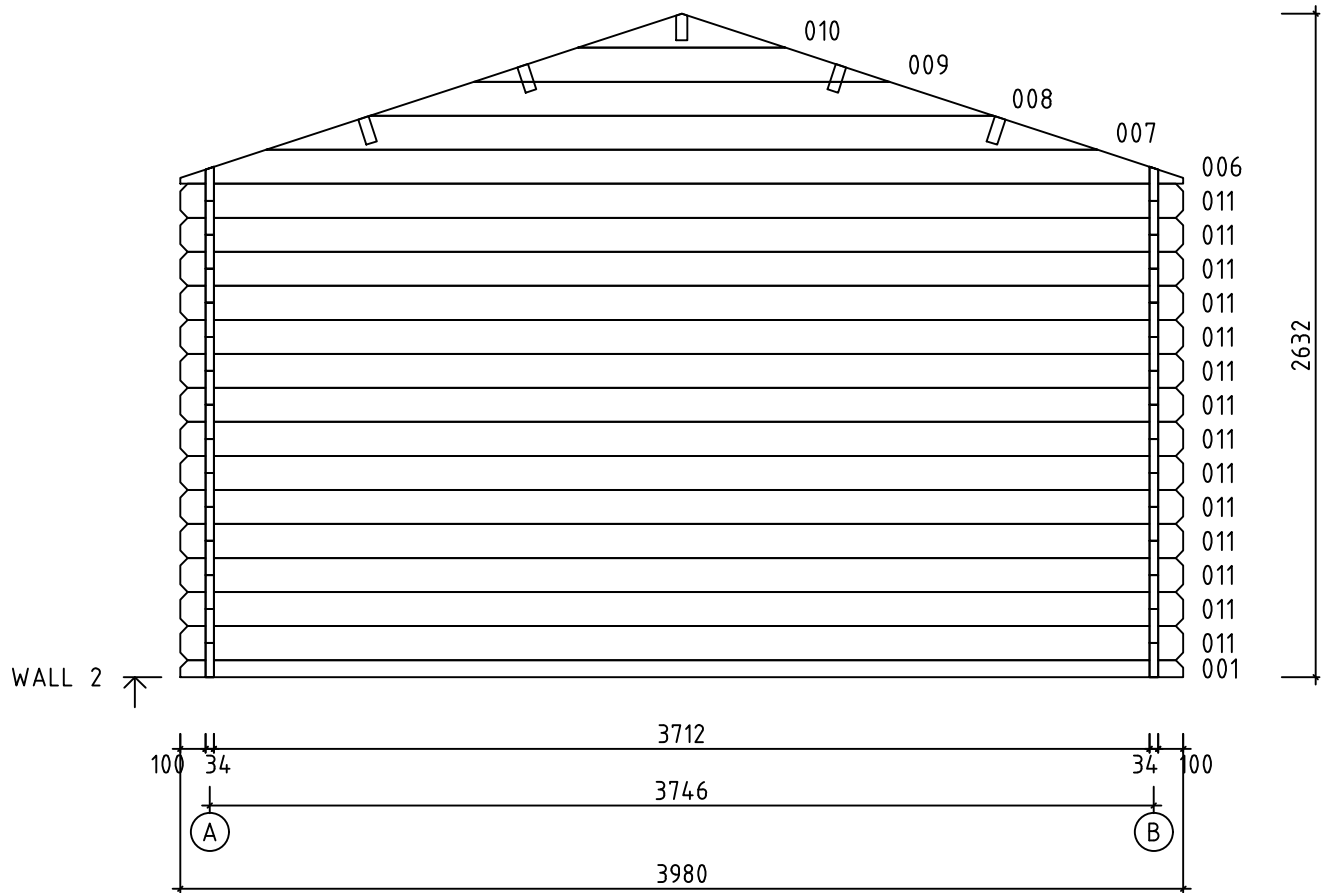

|       |                |            |          |          |                    |       |      |  |
|-------|----------------|------------|----------|----------|--------------------|-------|------|--|
| Model | Gabriel 34 4x3 |            | Drawing  | WALL 1   |                    | Page  | 5    |  |
|       | Drawn by       | J.S        | Material | 3.4x13.5 |                    | Scale | 1:30 |  |
|       | Date           | 08.05.2024 |          | File     | Gabriel 34 4x3.dwg |       |      |  |



|   |                |            |          |                    |       |      |
|---|----------------|------------|----------|--------------------|-------|------|
| Model   | Gabriel 34 4x3 | Drawing    | WALL 2   | Page               | 6     |      |
|  | Drawn by       | J.S        | Material | 3.4x13.5           | Scale | 1:30 |
|   | Date           | 08.05.2024 | File     | Gabriel 34 4x3.dwg |       |      |