

Alphol 

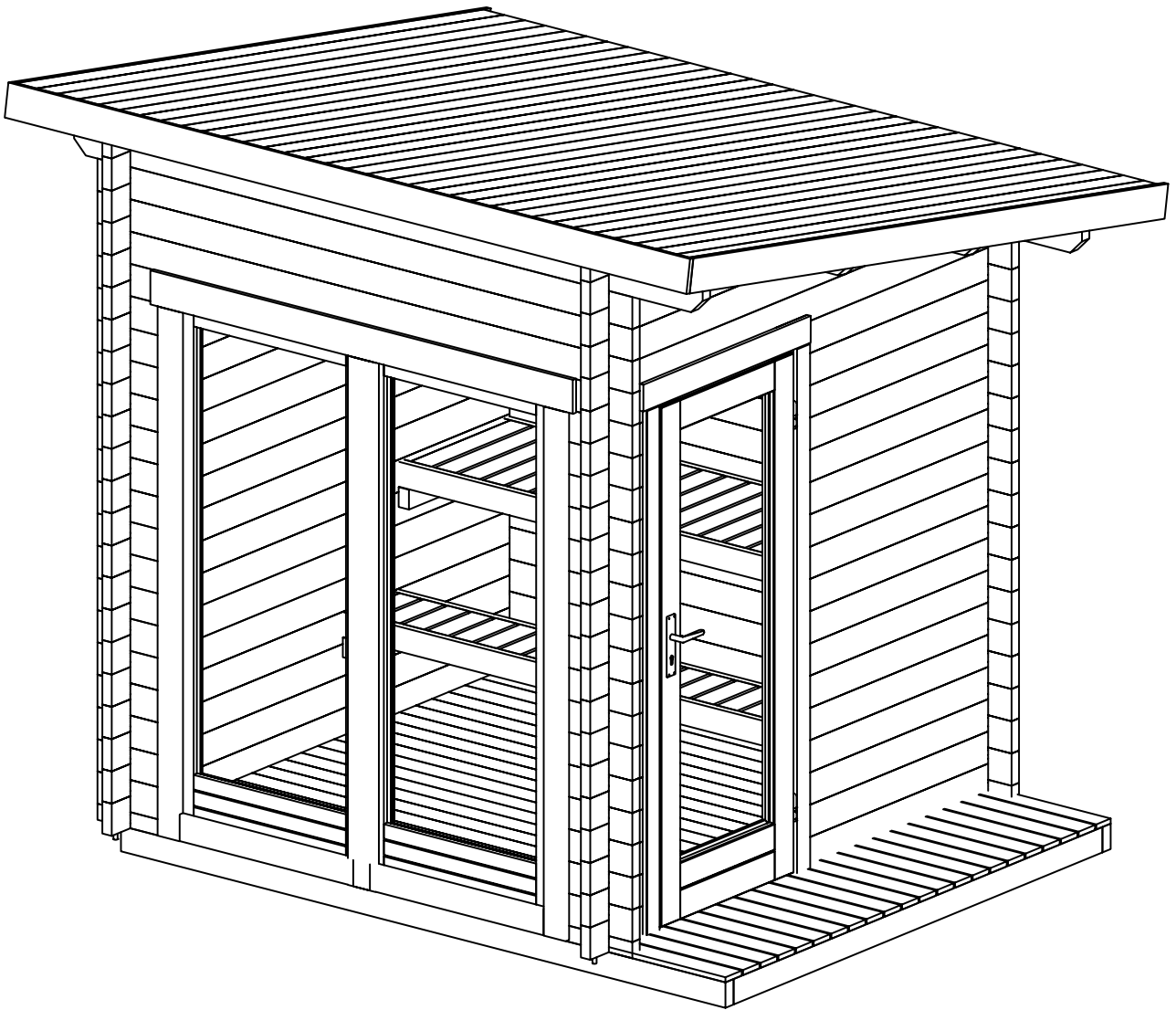

Sauna Lizzy 40 XS

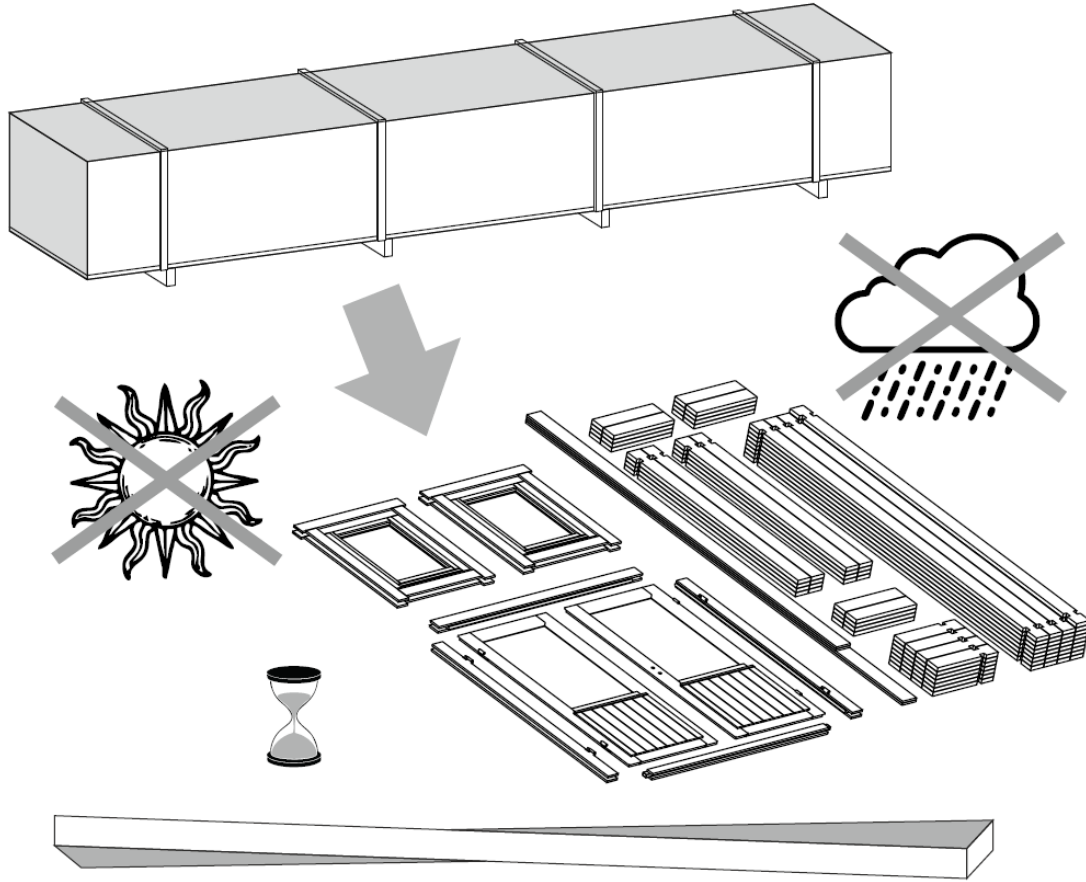

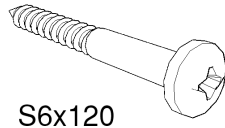
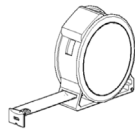
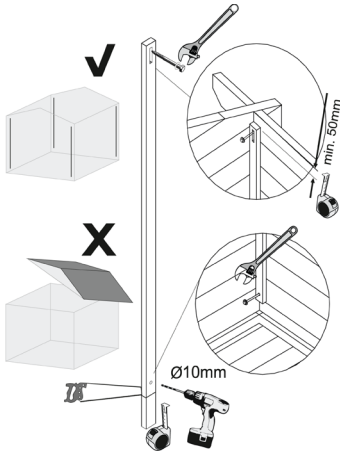

S6x120

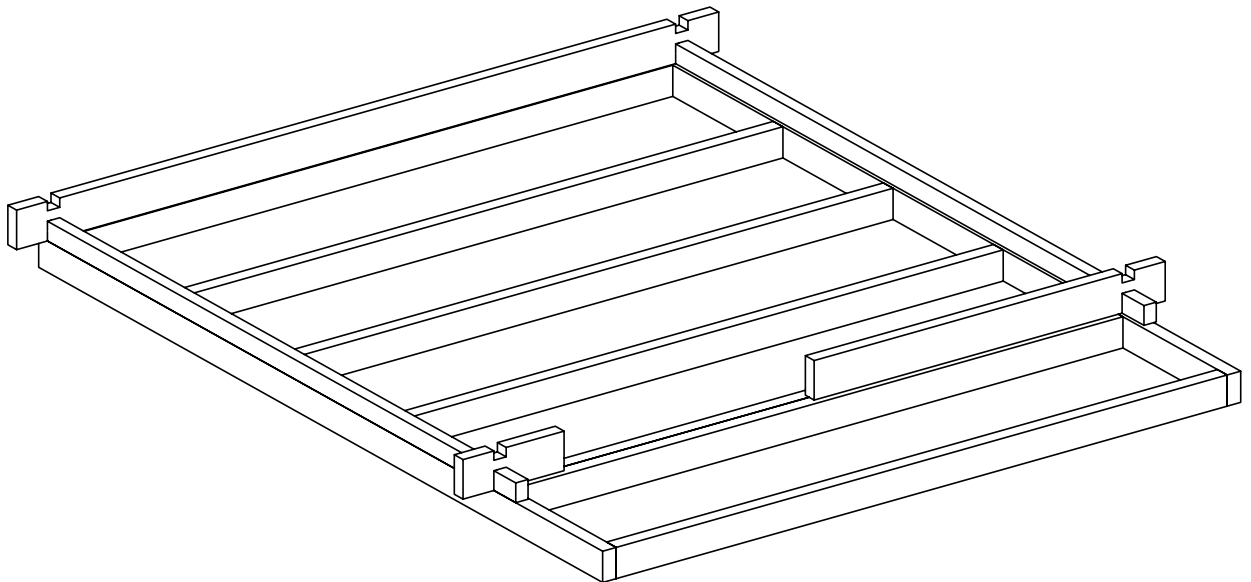
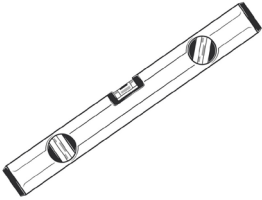
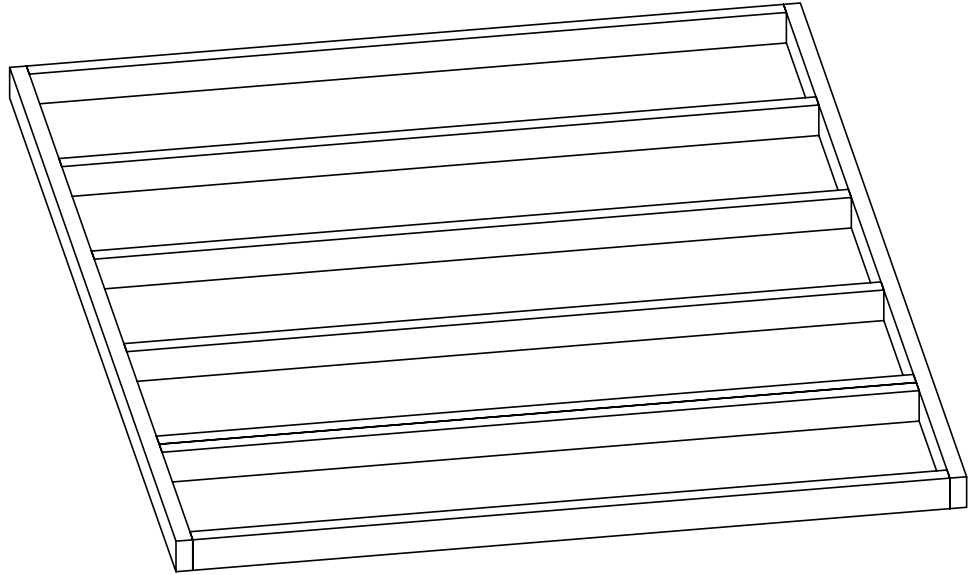
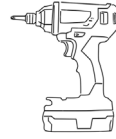

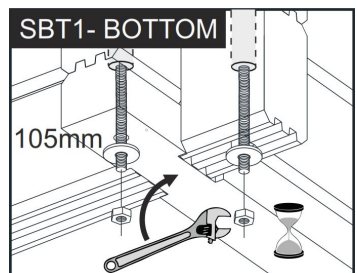
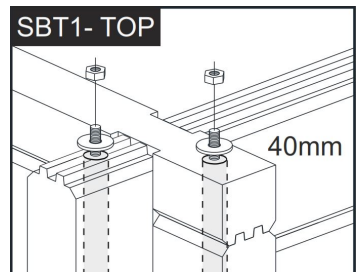
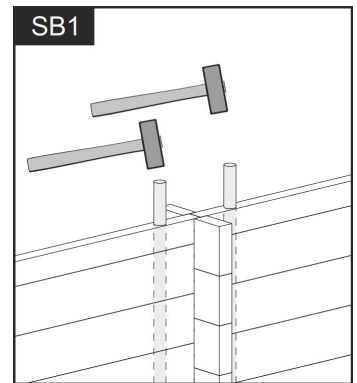
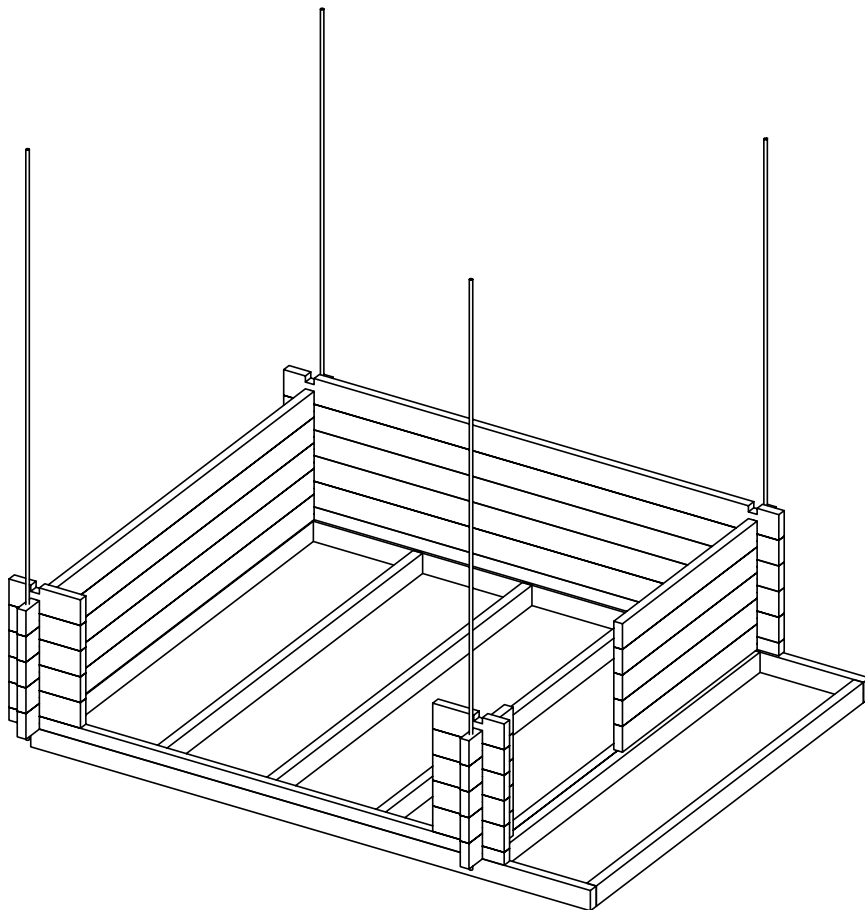
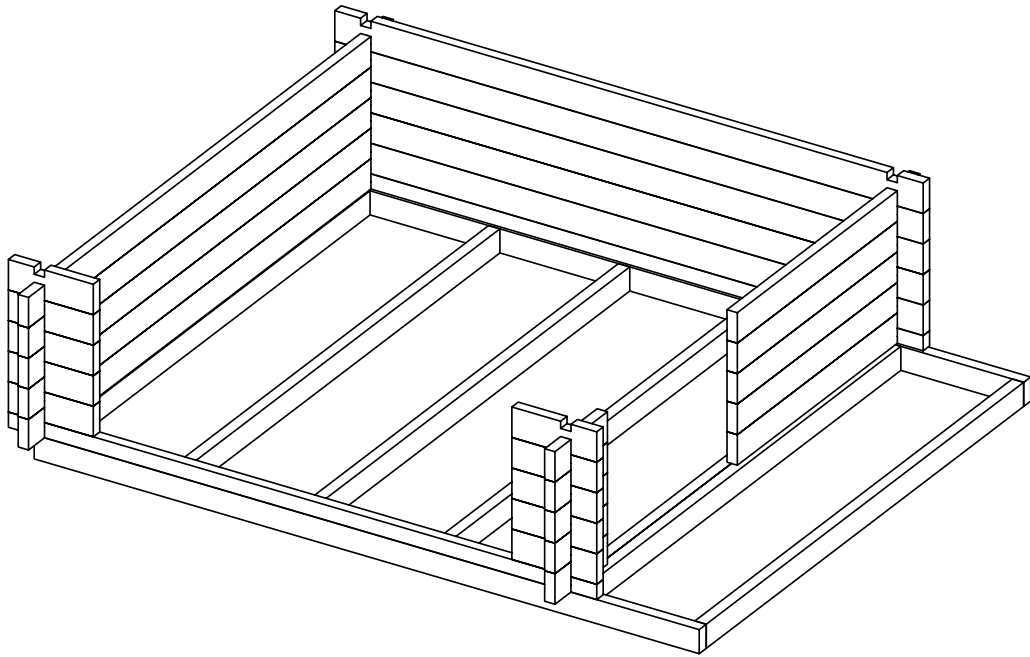

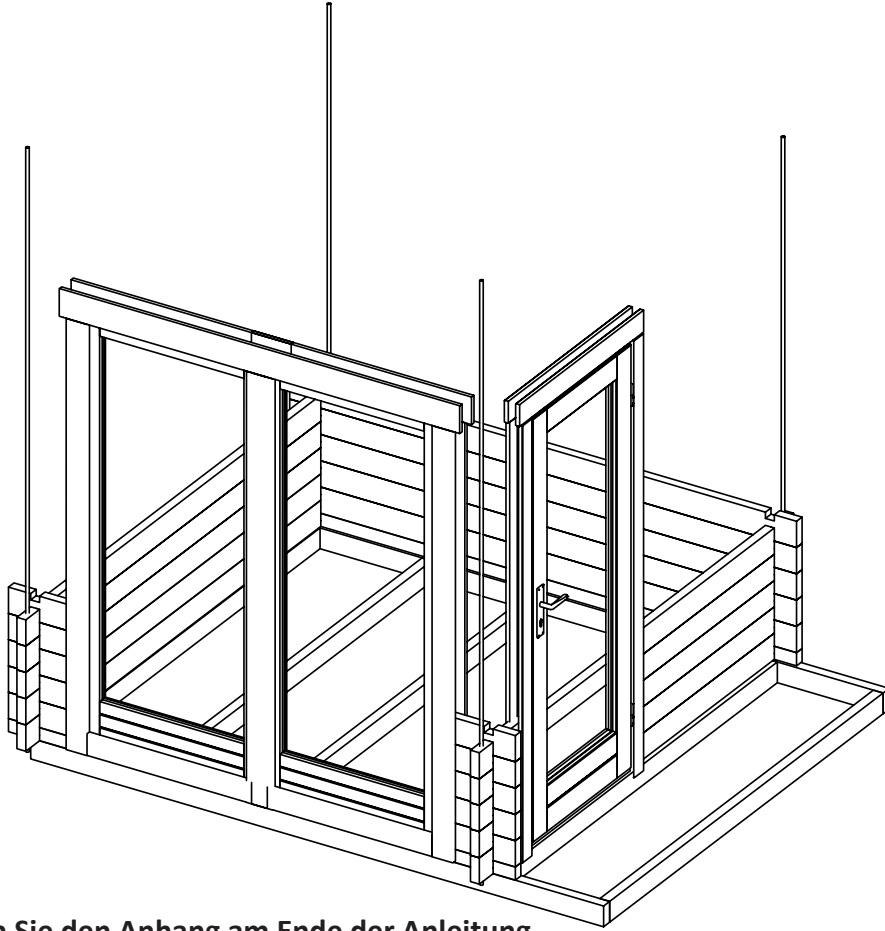

**Bitte beachten Sie den Anhang am Ende der Anleitung.
Please refer to the appendix of this section.**

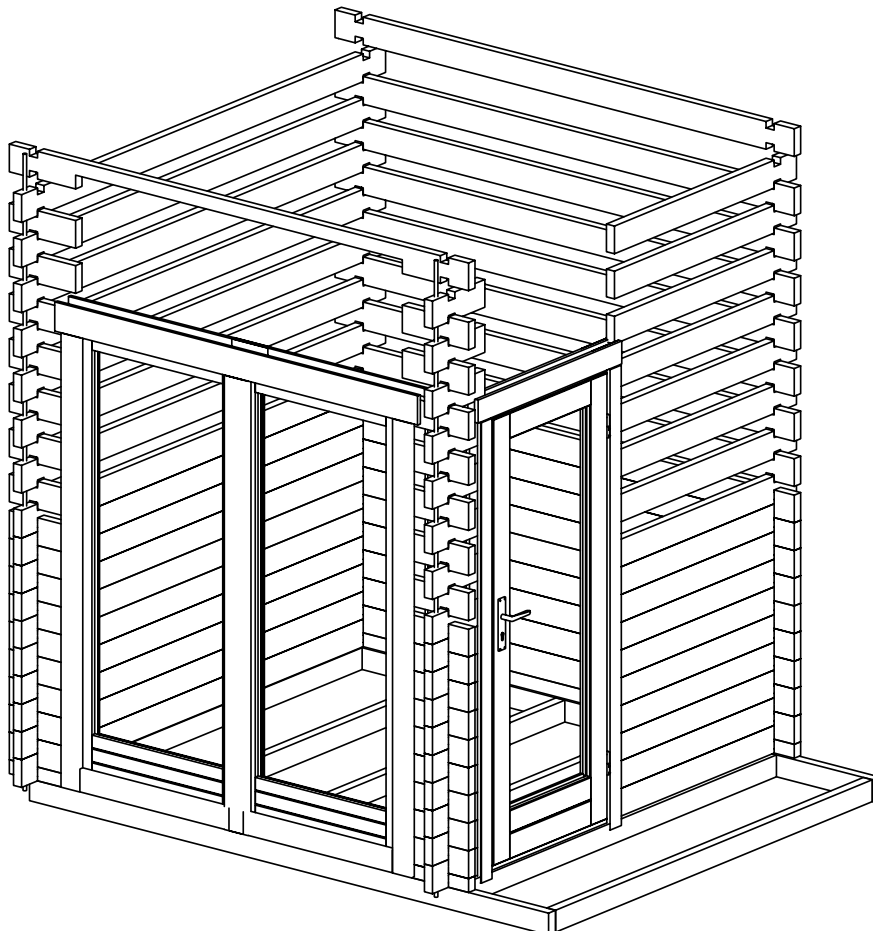

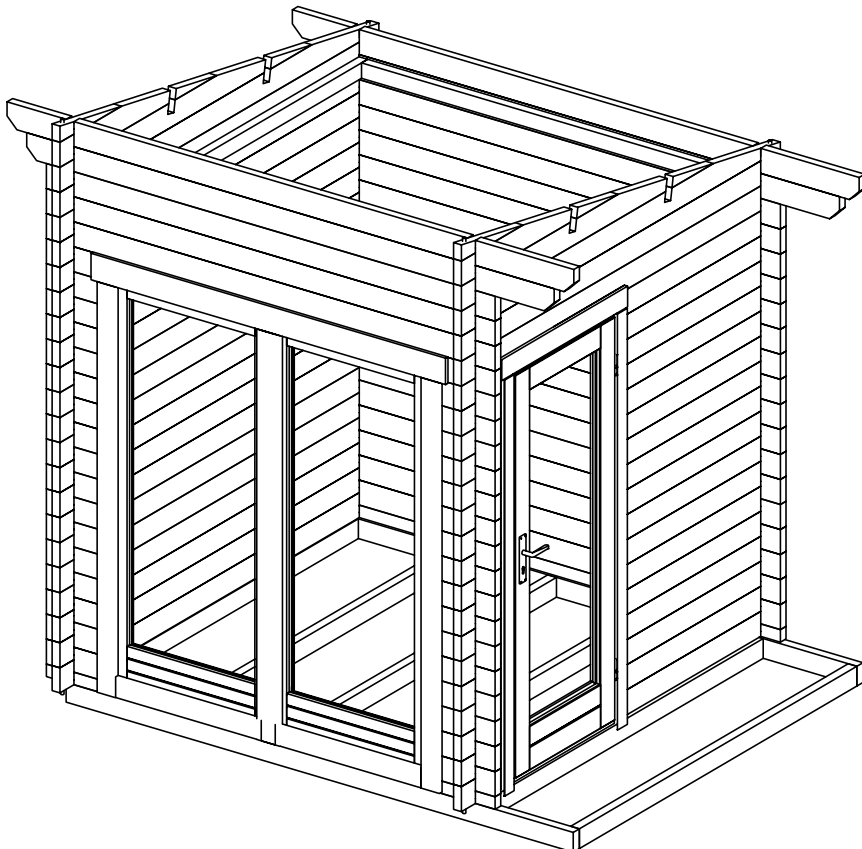
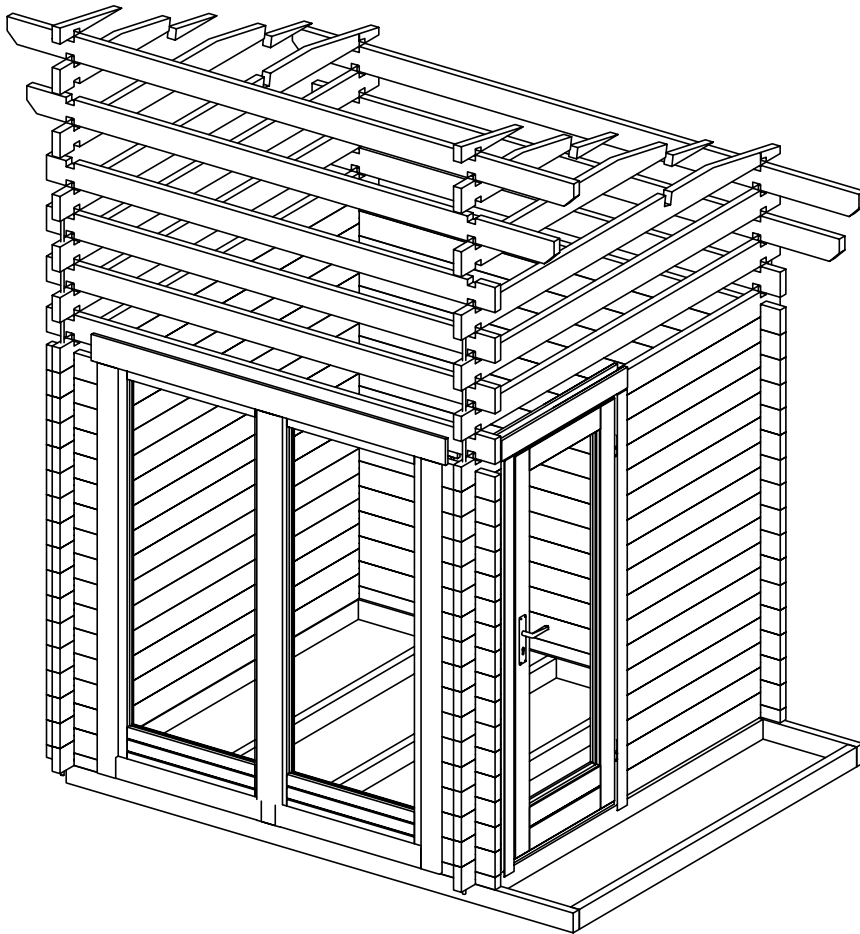

4

Bitte beachten Sie den Anhang am Ende der Anleitung.
Please refer to the appendix of this section.

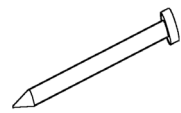
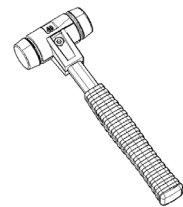
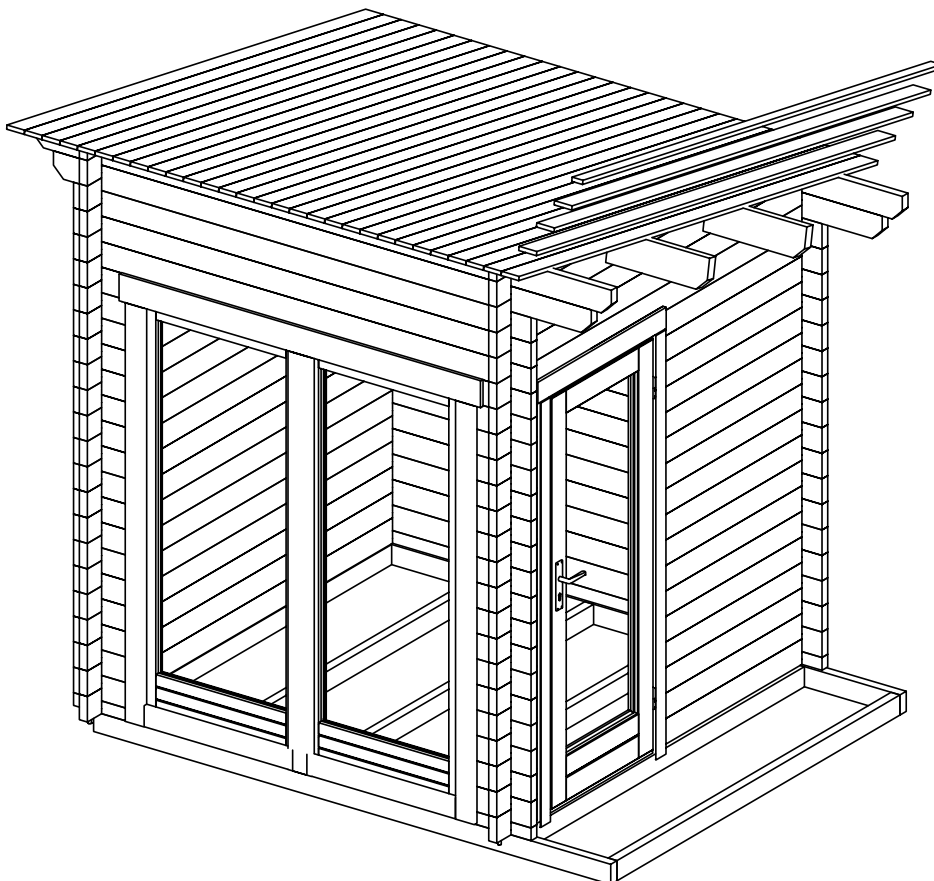
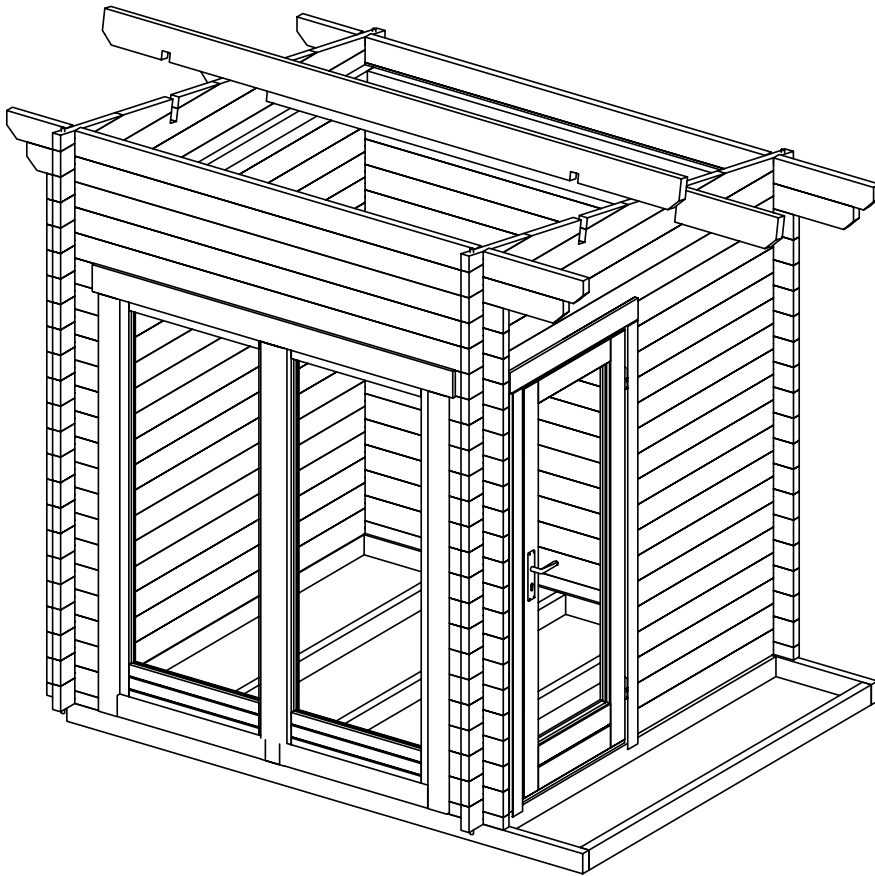

N1,8x40

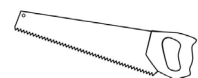

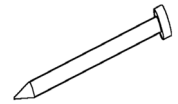
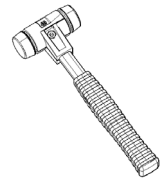
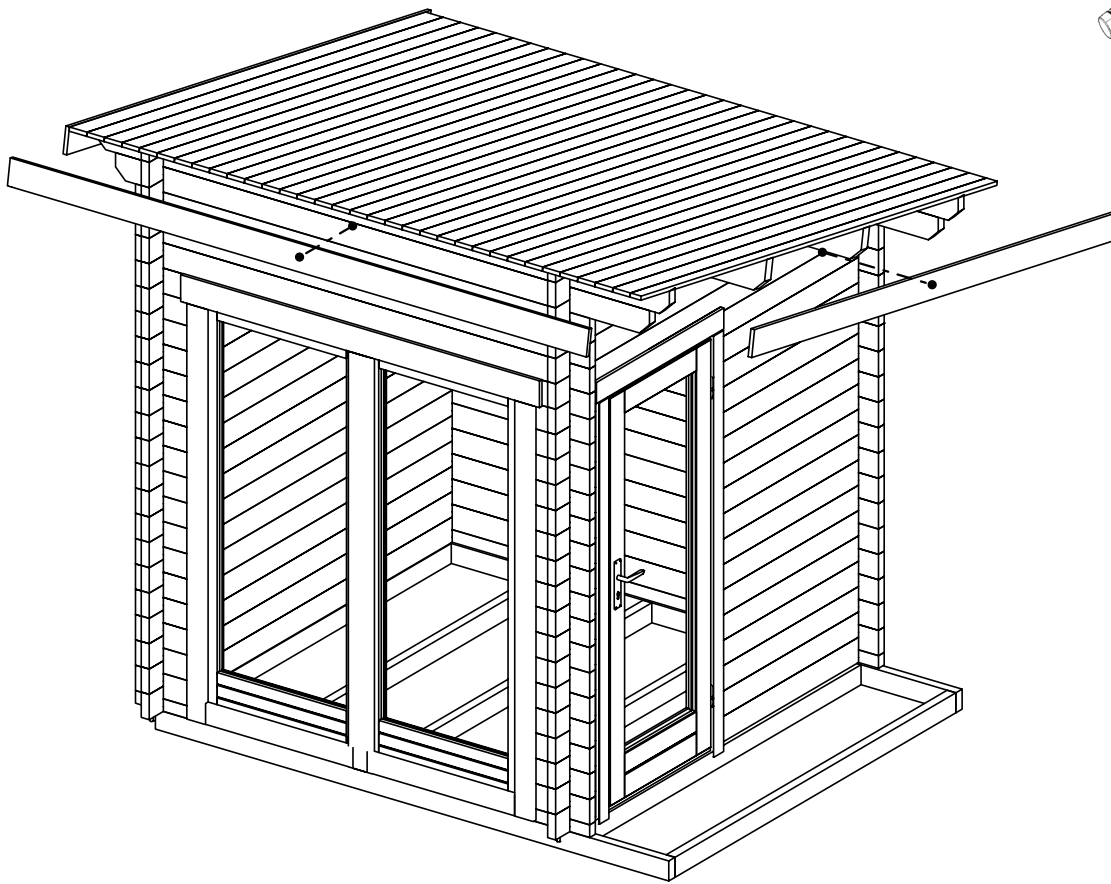

N1,8x40

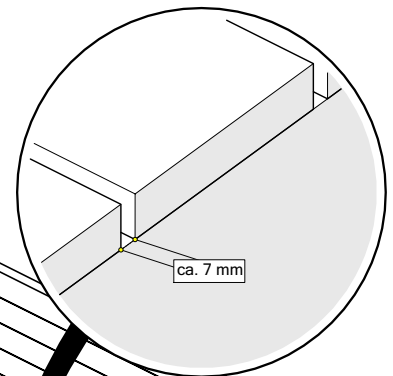
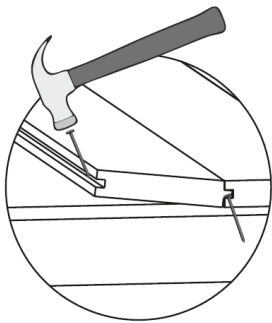

ca. 7 mm

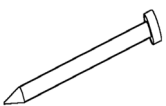
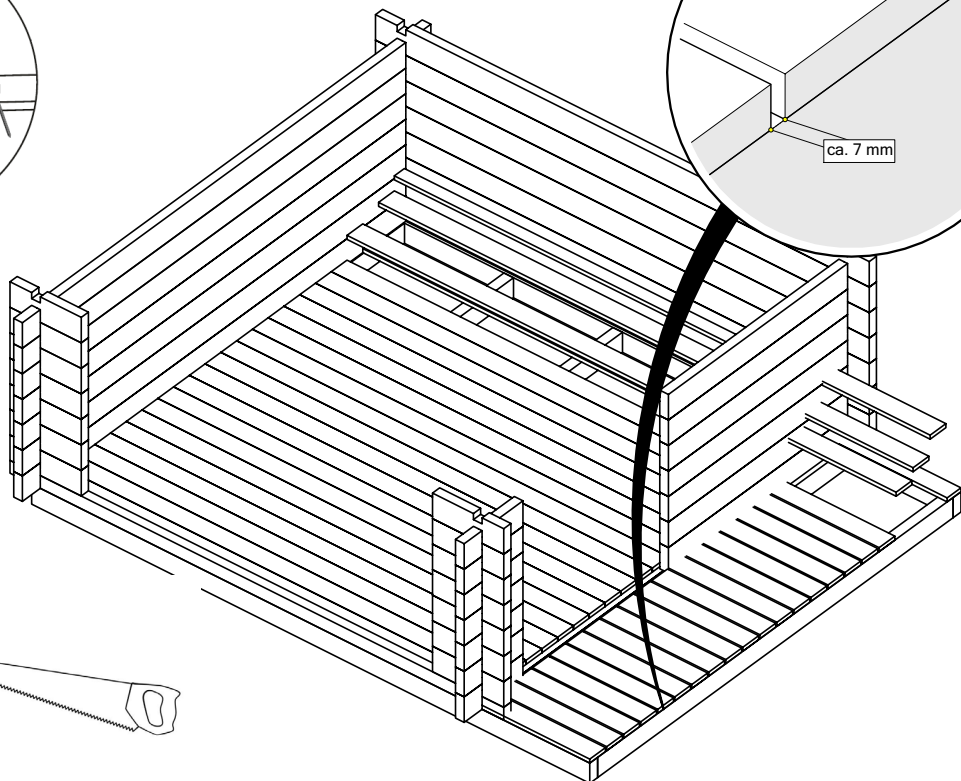
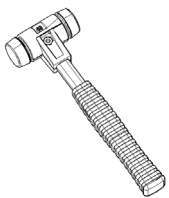

N1,8x40

6

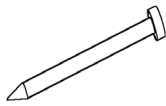
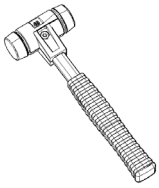
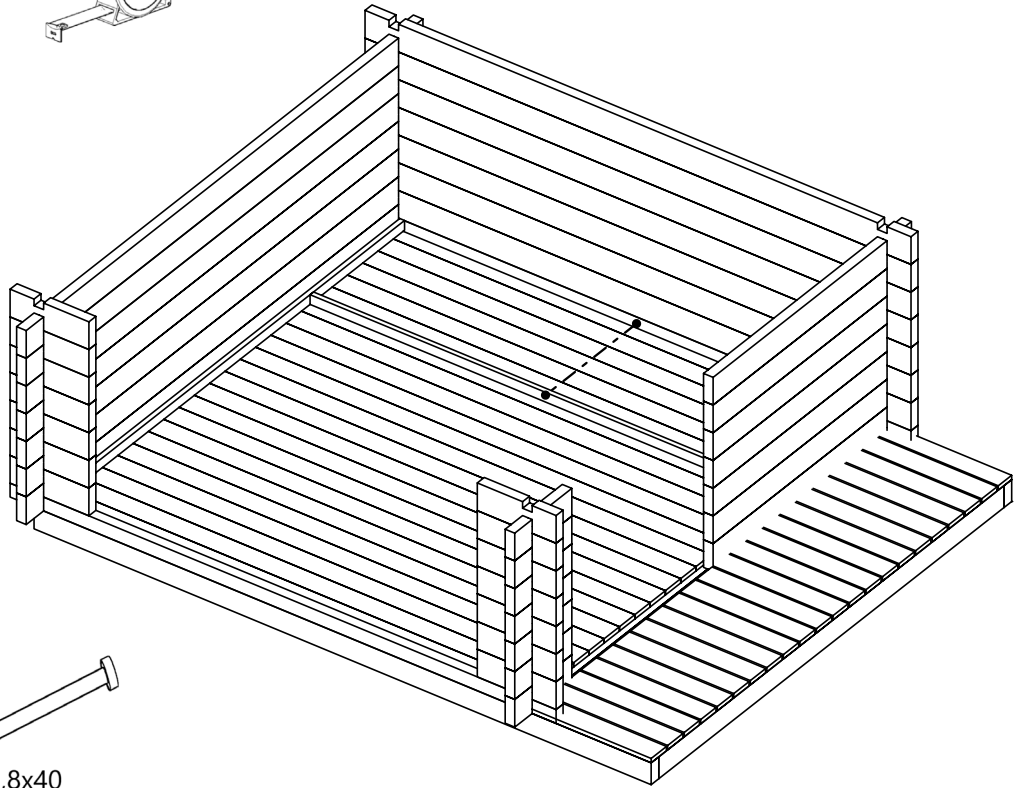
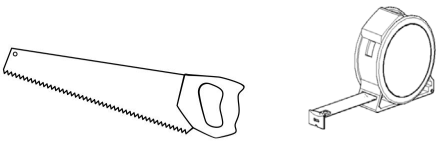

N1,8x40

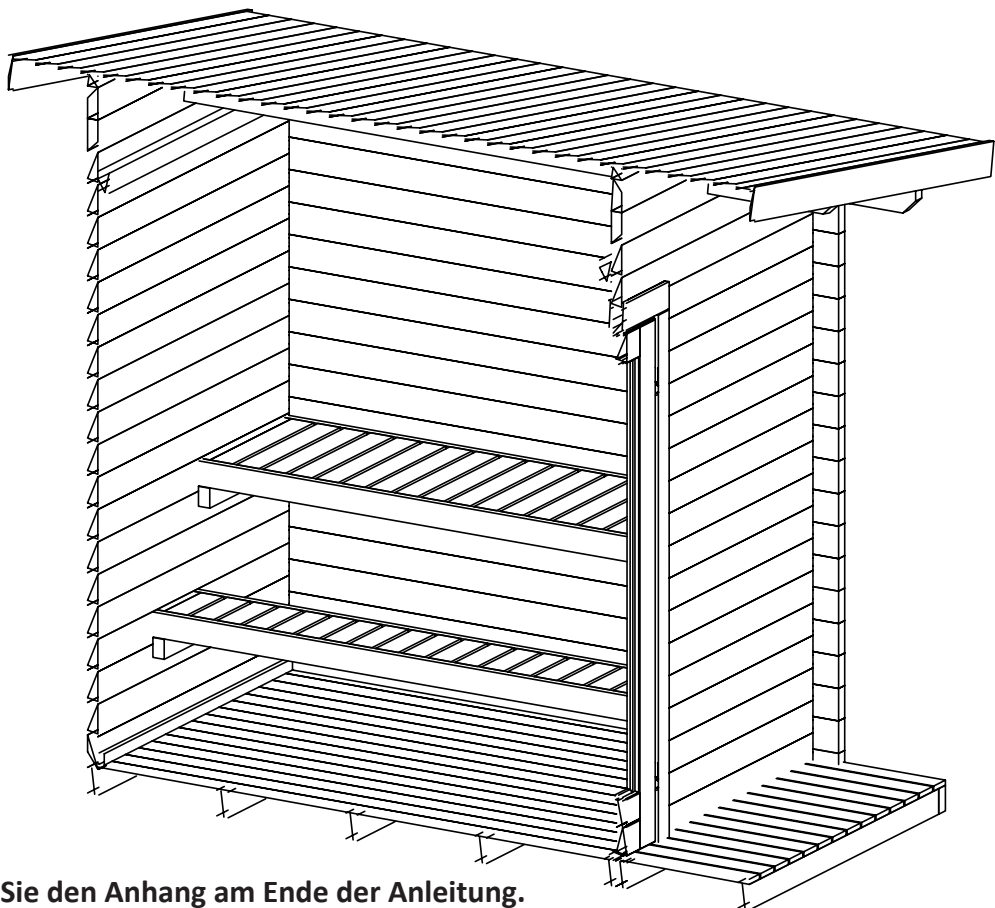

Bitte beachten Sie den Anhang am Ende der Anleitung.
Please refer to the appendix of this section.

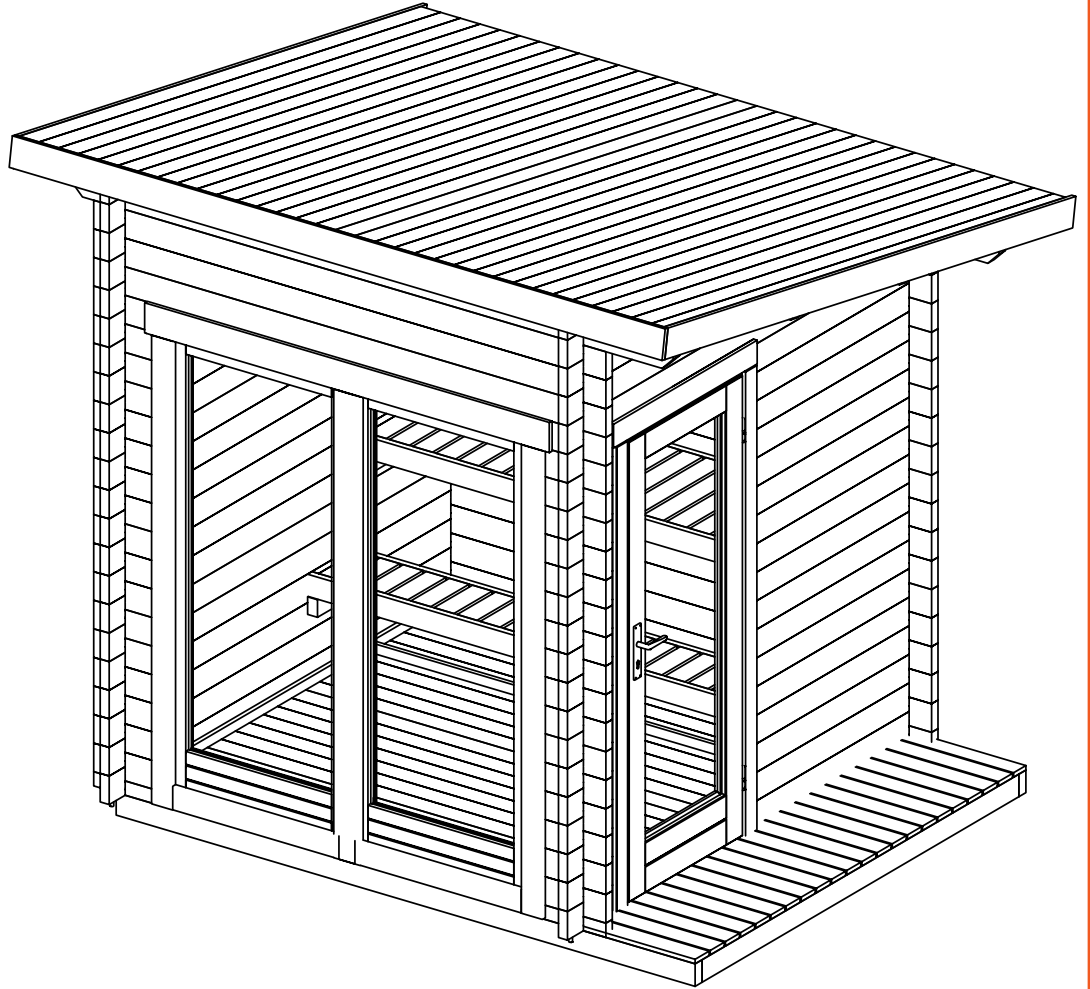
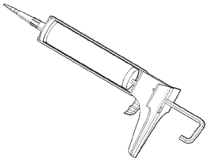
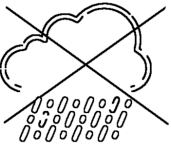
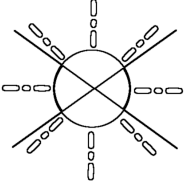

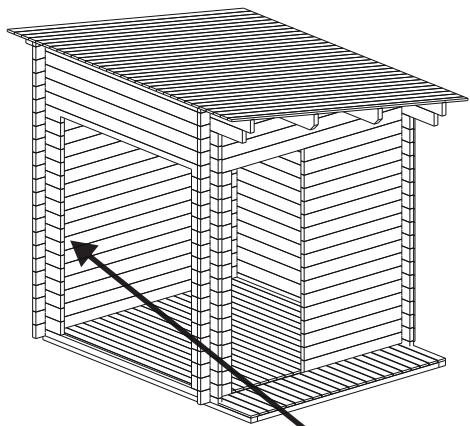

4x60

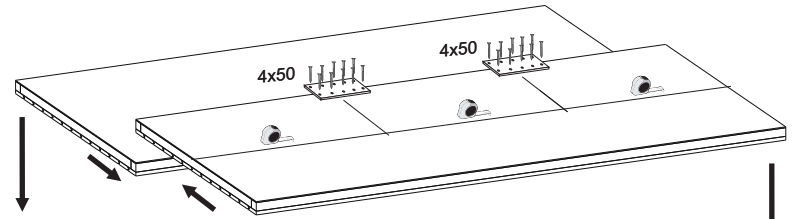
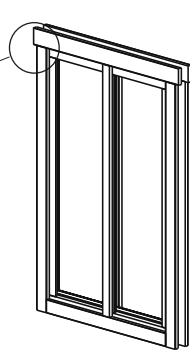
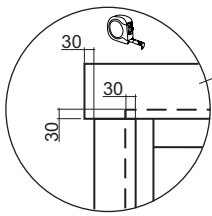

4x50

4x50

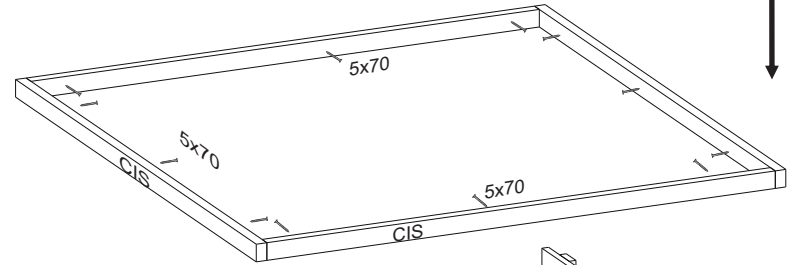

5x70

CIS

5x70

CIS

5x70

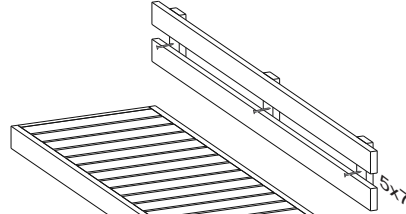

5x70

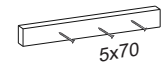

5x70



5x70

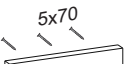

5x70



5x70

NB! Before roofing

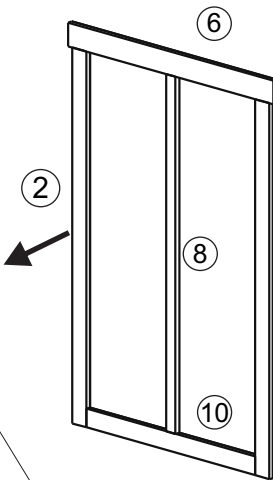

12

8

10

6

2



4x60

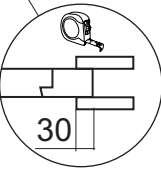

30

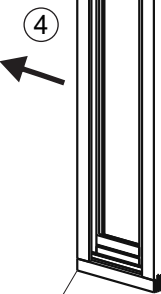
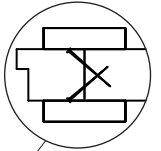

4

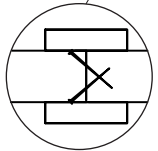

4x60

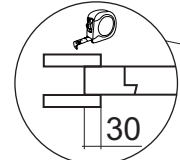

30

3



4

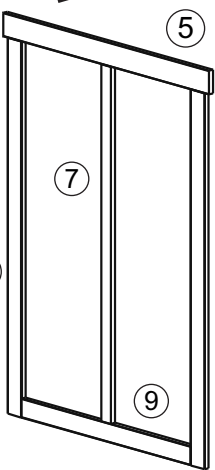

1

5

7

9







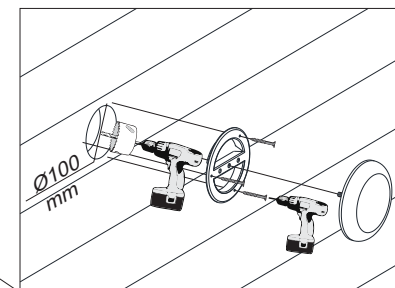
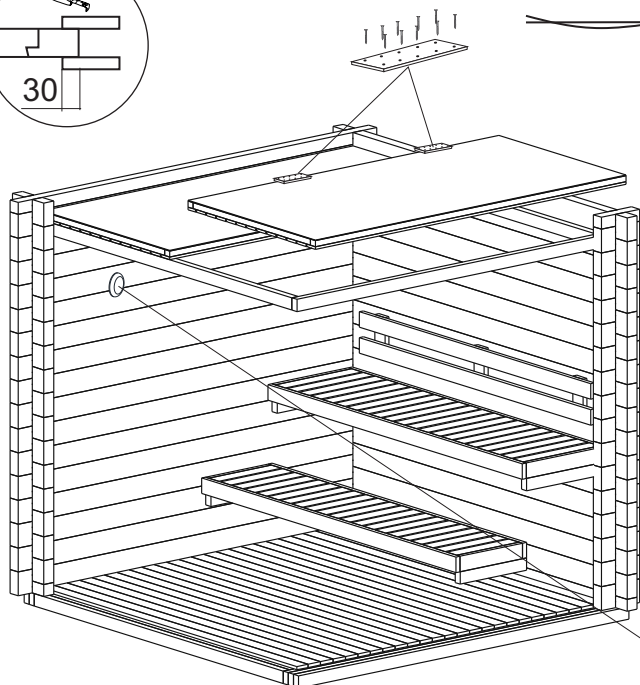

11

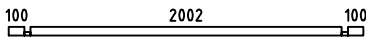

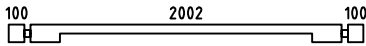
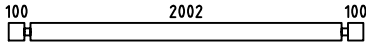
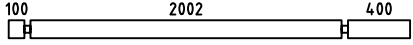
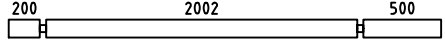
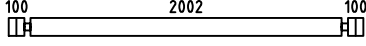

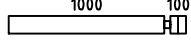
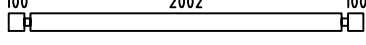
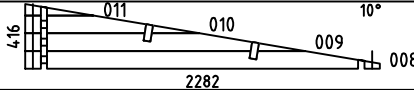
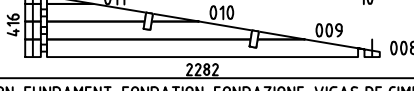
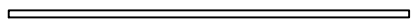
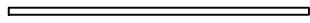
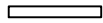

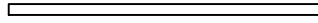
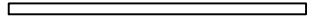
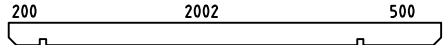
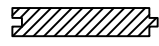
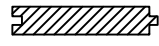
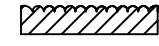



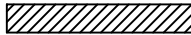

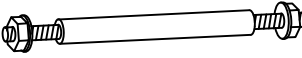
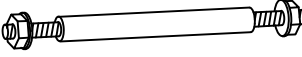

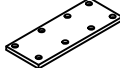

4x60



Ø100 mm

Pos	Specification-Spezifikation-Specificatie-Nomenclature-Elementi-Especificacion Sauna Lizzy 40 XS	Qty	Profile (mm)	Lenght (mm)
001		2	40x57	2282
002		32	40x114	330
003		1	40x114	2282
004		20	40x114	2282
005		2	40x114	2582
006		2	40x114	2782
007		21	40x114	2282
012		17	40x114	330
013		17	40x114	1140
EXTRA		1	40x114	2282
WA-1		1		
WB-1		1		
F2	FOUNDATION-FUNDAMENT-FONDATION-FONDAZIONE-VIGAS DE CIMENTACIÓN 	2	70x44	2577
F1	FOUNDATION-FUNDAMENT-FONDATION-FONDAZIONE-VIGAS DE CIMENTACIÓN 	7	70x44	1932
UBS1	UPPER BENCH SUPPORT-TRAGELEISTE-STEUNEN BAR-SUPPORT-SUPPORTO-SOPORTE 	2	44x70	595
LBS1	LOWER BENCH SUPPORT-TRAGELEISTE-STEUNEN BAR-SUPPORT-SUPPORTO-SOPORTE 	2	44x70	295
CIS1	CEILING INSULATION SUPPORT-TRAGELEISTE-STEUNEN BAR-SUPPORT-SUPPORTO-SOPORTE 	2	44x70	2000
CIS2	CEILING INSULATION SUPPORT-TRAGELEISTE-STEUNEN BAR-SUPPORT-SUPPORTO-SOPORTE 	2	44x70	1912
PL1	PURLIN-DAKBALK-DACHPFETTE-PANNE-ARCARECCIO-CORREA 	2	44x144	2782
F-1	Floor board-Fussbodenbrett-Vloerplank-Lame de plancher-Tavola pavimento-Tabla de suelo 	23+1 18+1	88x18 114x18	1992
R-1	Roof board-Dachbrett-Dakplank-Volige-Tavola tetto-Tabla de tejado 	32+1 25+1	88x18 114x18	2550
T-1	Terrace board-Terrassendiele-Vloderplank-Lame de terrasse-Tavola terrazzo-Tabla de terraza 	22+1	88x18	500
FLB-1	Floor beading 3000-Fussbodenleiste-Plinten-Moulure de finition-Listello pavimento-Liston de suelo 	3	18x40	9rmt.
Kood	Sauna Lizzy 40 XS	Materjal	File Sauna Lizzy 40 XS.dwg	Leht 1/3

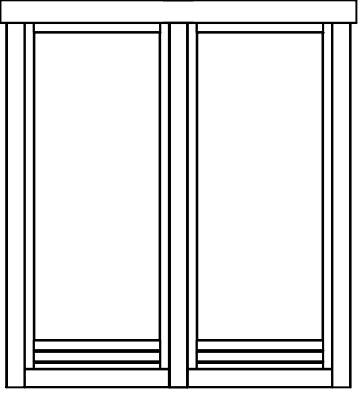
Pos	Specification-Spezifikation-Specificatie-Nomenclature-Elementi-Especificacion Sauna Lizzy 40 XS	Qty	Profile (mm)	Lenght (mm)		
GB-1	Gable board 120-Giebelblende-Gevelplank-Planche de rive-Tavola di bordo-Tabla de borde 	2	18x120	2590		
GB-2	Gable board 120-Giebelblende-Gevelplank-Planche de rive-Tavola di bordo-Tabla de borde 	2	18x120	2822		
RL-1	Roofing lath 3000-Giebelleiste-Gevellijst-Latte de rive-Listello di bordo-Listones de borde 	4	18x40	12rmt.		
TSB1	Threaded steel bar kit-Gewindestange satz-Draadstang set-Kit de tiges filetées-Kit barra filettata-Kit barra roscada 	2	"14	2620		
TSB2	Threaded steel bar kit-Gewindestange satz-Draadstang set-Kit de tiges filetées-Kit barra filettata-Kit barra roscada 	2	"14	2250		
	Backrest-Rückenlehne-Rugleuning-Dossier-Schienale-Respaldo 	1	235x1800			
	Bracket 140x40-Lochplatte-Gatenplaat-Connecteur métallique-Piastre forate-Placas perforadas 	2	140x40			
CI	Ceiling Insulation-Deckelsolation-Plafondisolatie-Isolation du plafond-Isolamento del soffitto-Aislamiento de techo 	2	1990x995			
	Lower Bench-Untere Bank-Onderbank-Banc inférieur-Banco inferiore-Banco inferior 	1	360x2000			
	Nail 1.8x40-Nagel-Spijker-Clou-Chiodo-Clavo 	350	1.8x40			
	Sauna door kit-Sauna tür satz-Sauna deur set-Kit porte sauna-Kit sauna porta-Kit para sauna puerta 	1				
	Sauna ventilation kit-Außengitter-Schoepenrooster-Panneau de ventilation-Griglia di ventilazione-Rejilla de ventilacion 	1				
S4x50	Screw 4x50-Schraube-Schroef-Vis-Vite-Tornillo 	25	4x50			
S5x70	Screw 5x70-Schraube-Schroef-Vis-Vite-Tornillo 	30	5x70			
S6x120	Screw 6x120-Schraube-Schroef-Vis-Vite-Tornillo 	18	6x120			
	Upper bench-Obere Bank-Bovenbank-Banc supérieur-Banco superiore-Banco superior 	1	600x2000			
	WINDOW 800x1850+WINDOW 800x1850 W08 H 800x1850-40 TEMPERED 	1+1				
Kood	Sauna Lizzy 40 XS	Materjal	File	Sauna Lizzy 40 XS.dwg	Leht	2/3

H = 1.600 m
TOTAL: 4.01 m²

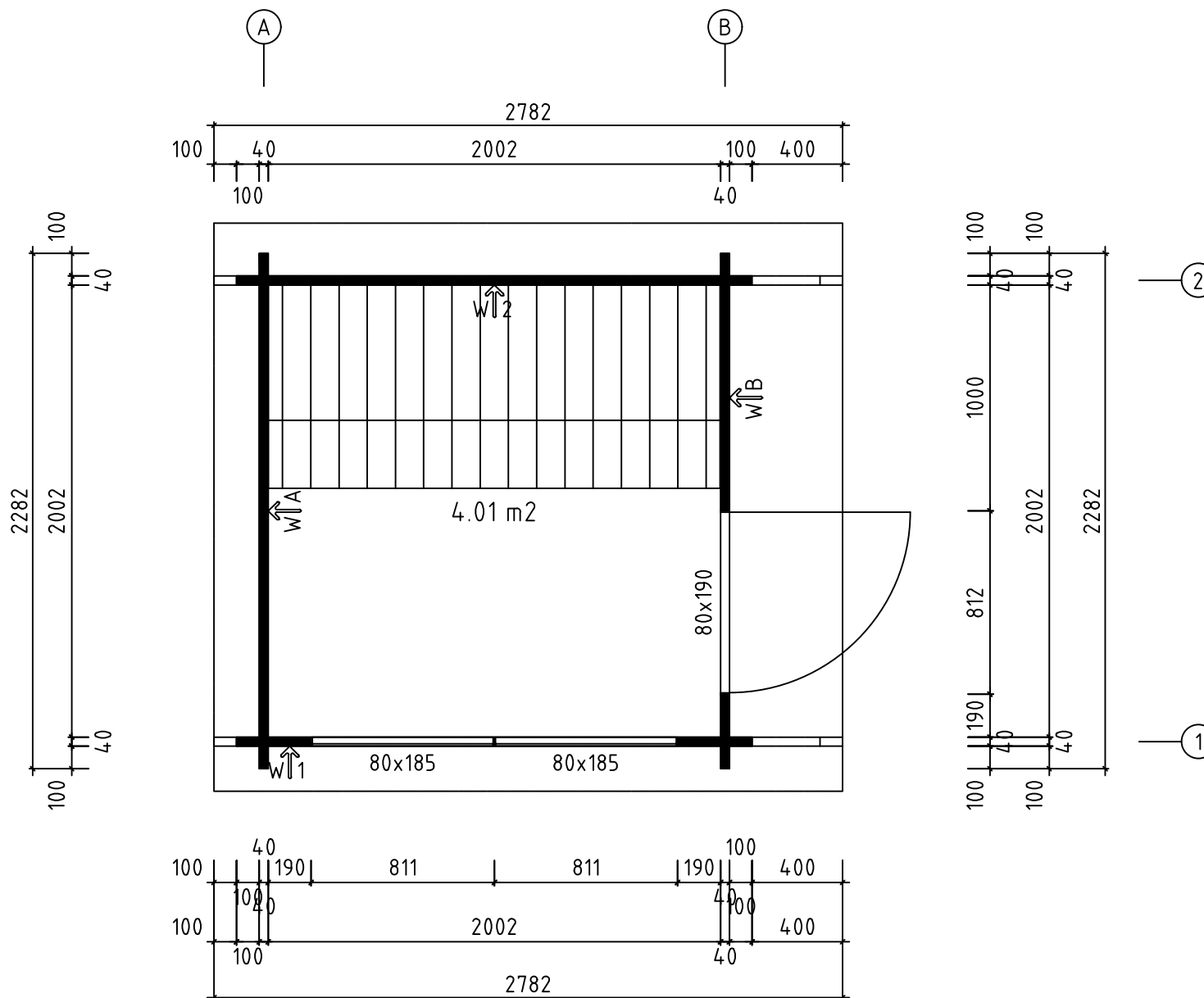

Model	Sauna Lizzy 4.0 XS	Drawing	PLAN	Page
		Drawn by	Material	40x114
		Date	05.07.2023	File
		Scale	1:20	

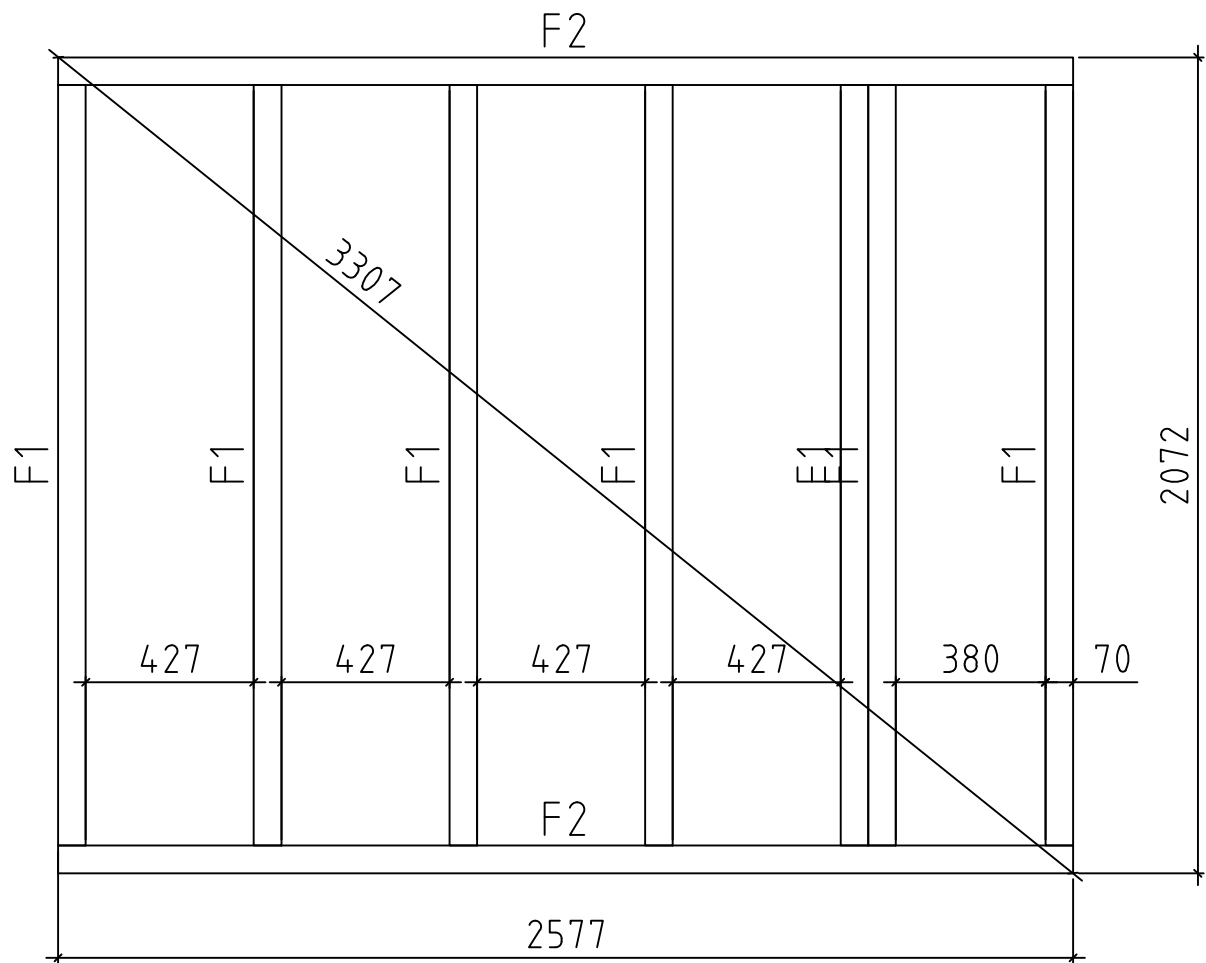

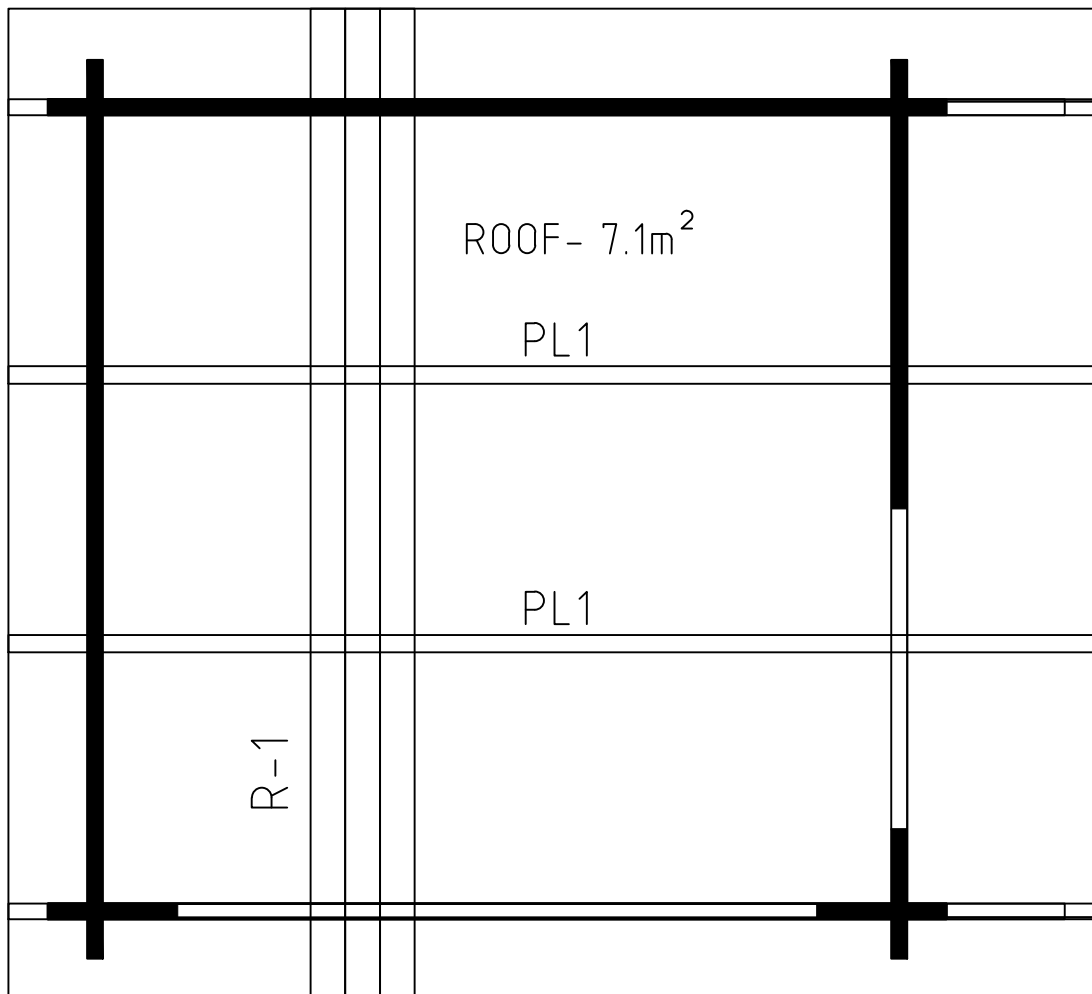

Model	Sauna Lizzy 40 XS	Drawing	FOUNDATION	Page
	Drawn by	Material	40x114	Scale
	Date	05.07.2023	File	Sauna Lizzy 40 XS.dwg

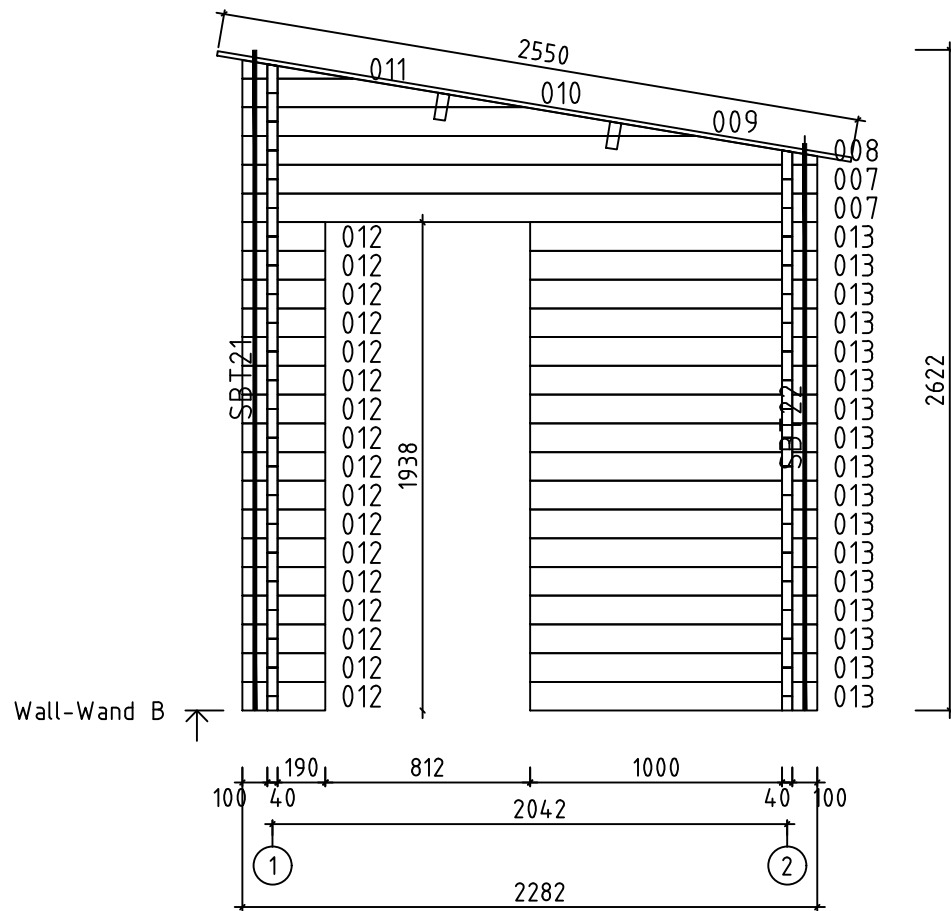

0 0.5m 1.0m 2.0m

Model	Sauna Lizzy 40 XS	Drawing	CEILING & ROOF	Page
		Drawn by	Material	40x114
		Date	05.07.2023	File
		Scale	1:20	



Model	Sauna Lizzy 40 XS	Drawing	WALL-WAND B	Page	4	
		Drawn by	Material	4x11.4	Scale	1:20
		Date	05.07.2023	File	Sauna Lizzy 40 XS.dwg	

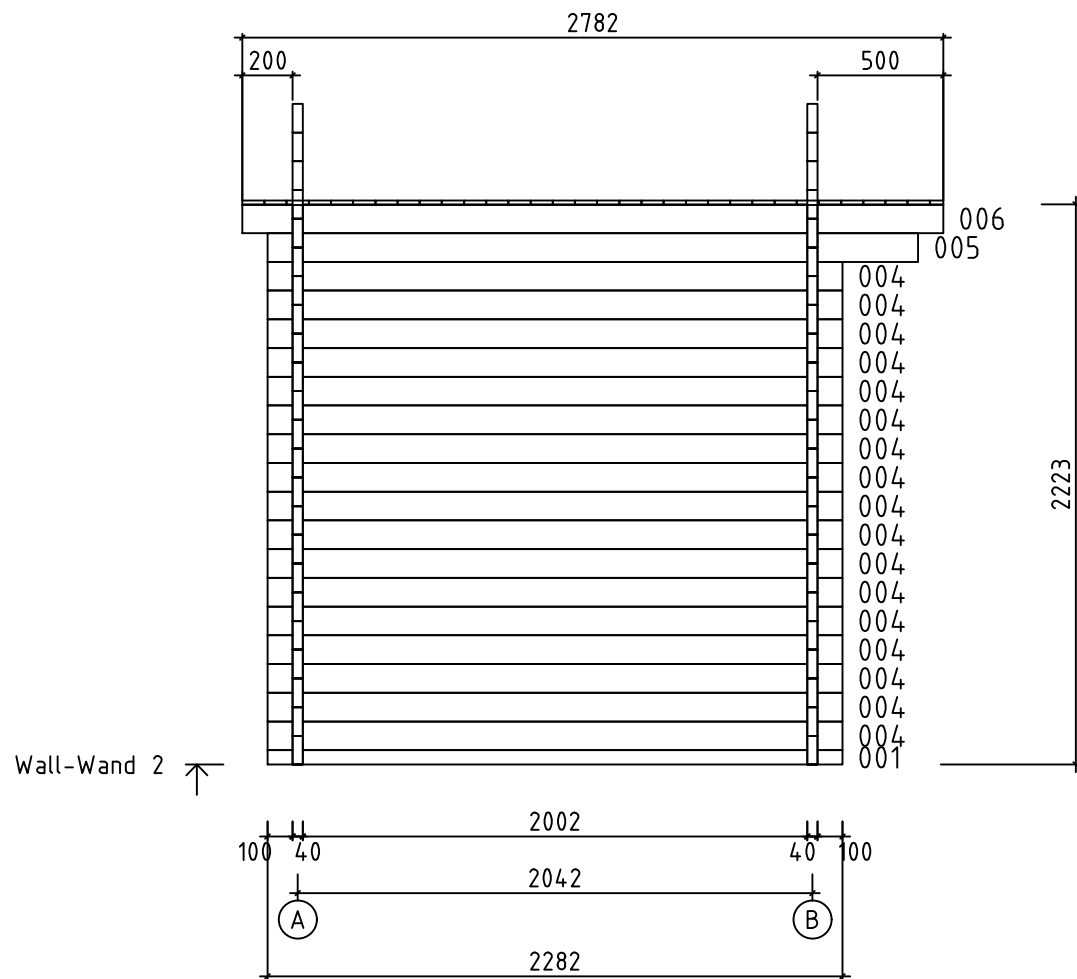

Wall-Wand 2 ↗

Model	Sauna Lizzy 40 XS	Drawing	WALL-WAND 2	Page	6
	Drawn by	Material	4x11.4	Scale	1:20
	Date	05.07.2023	File	Sauna Lizzy 40 XS.dwg	