

Alphol 

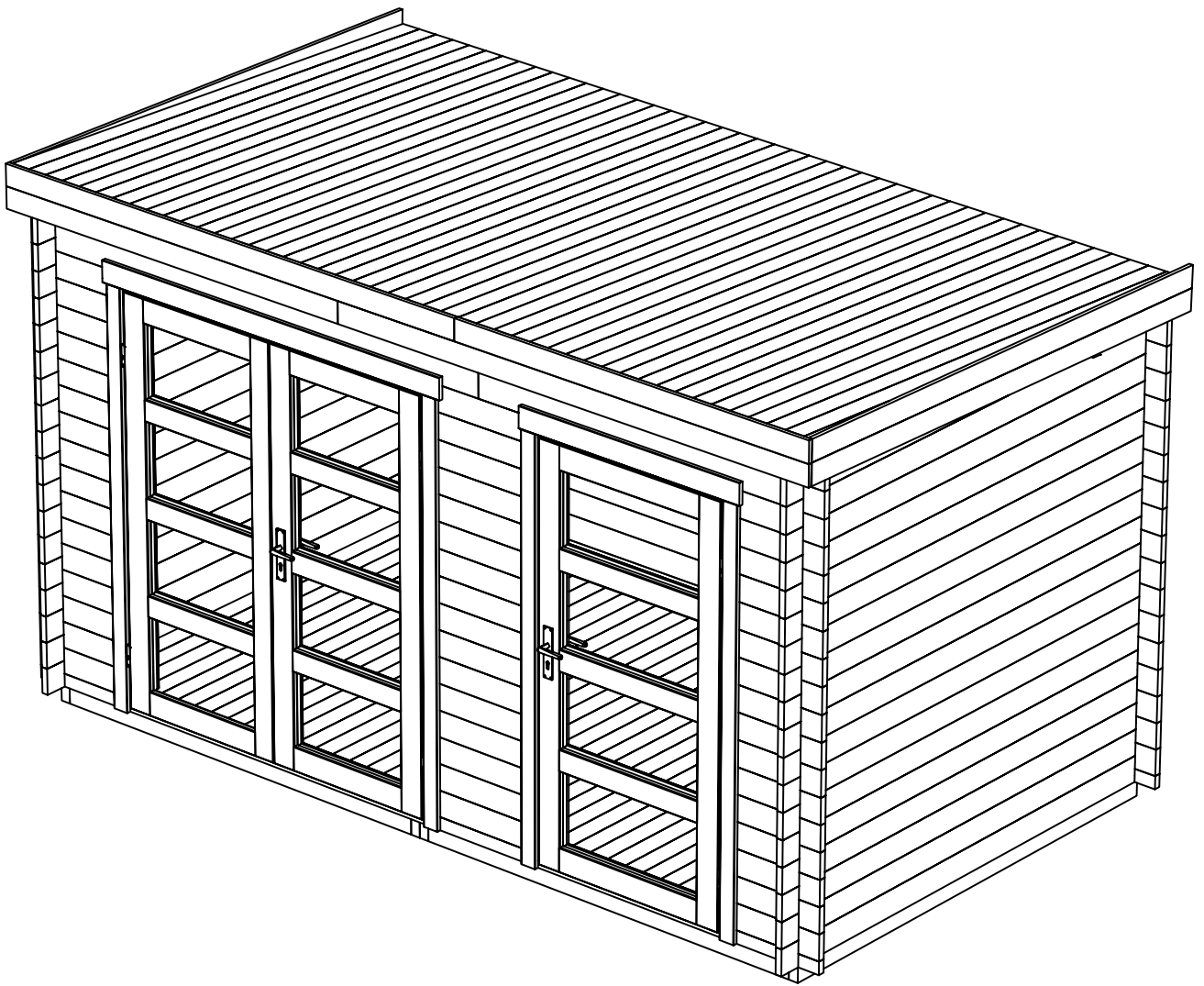

Flat pallet 4x2,3

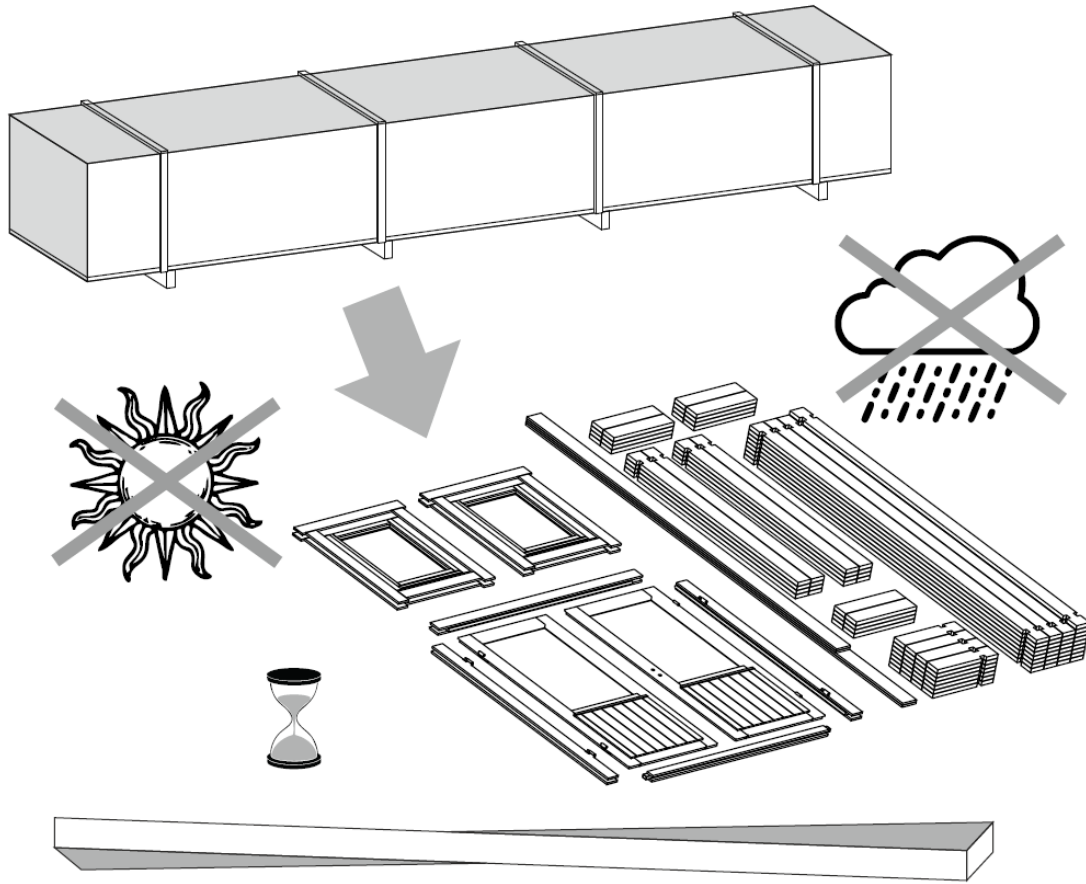

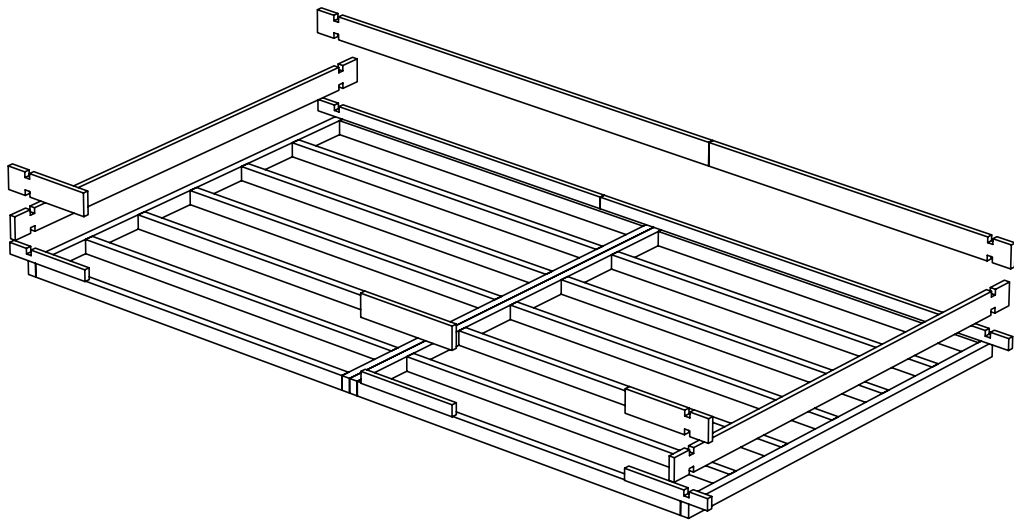
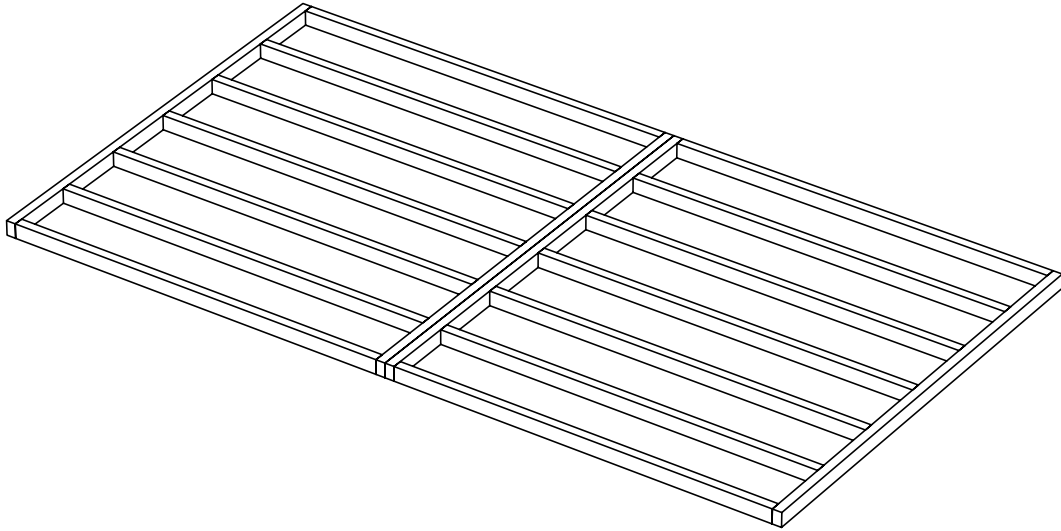
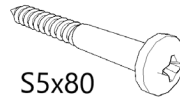
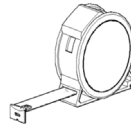
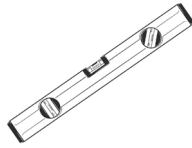
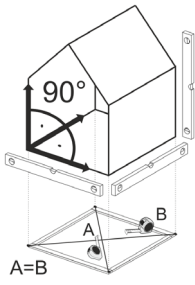

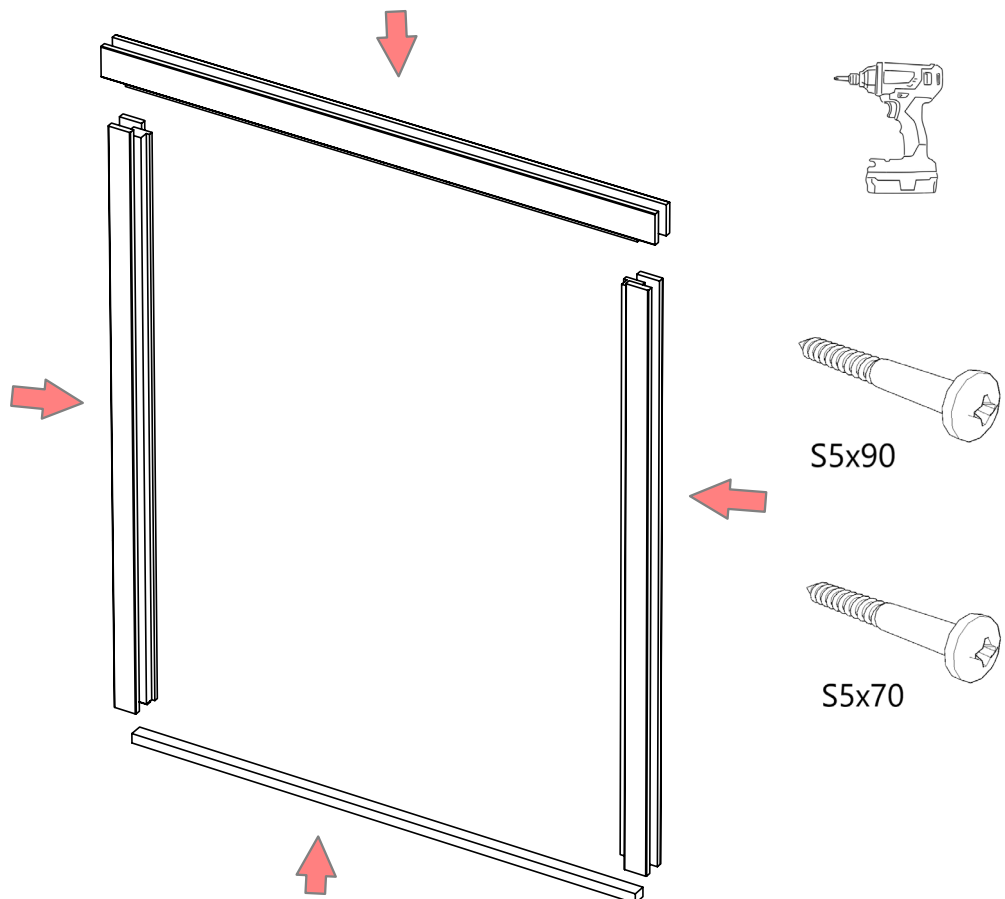
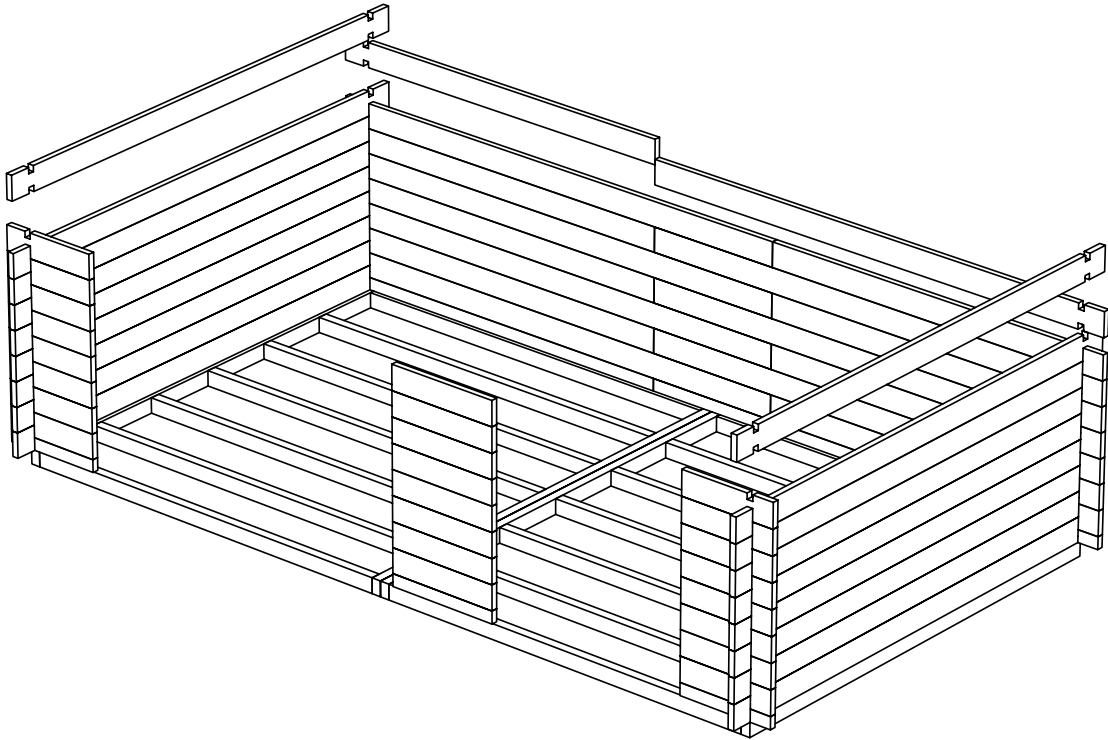

2

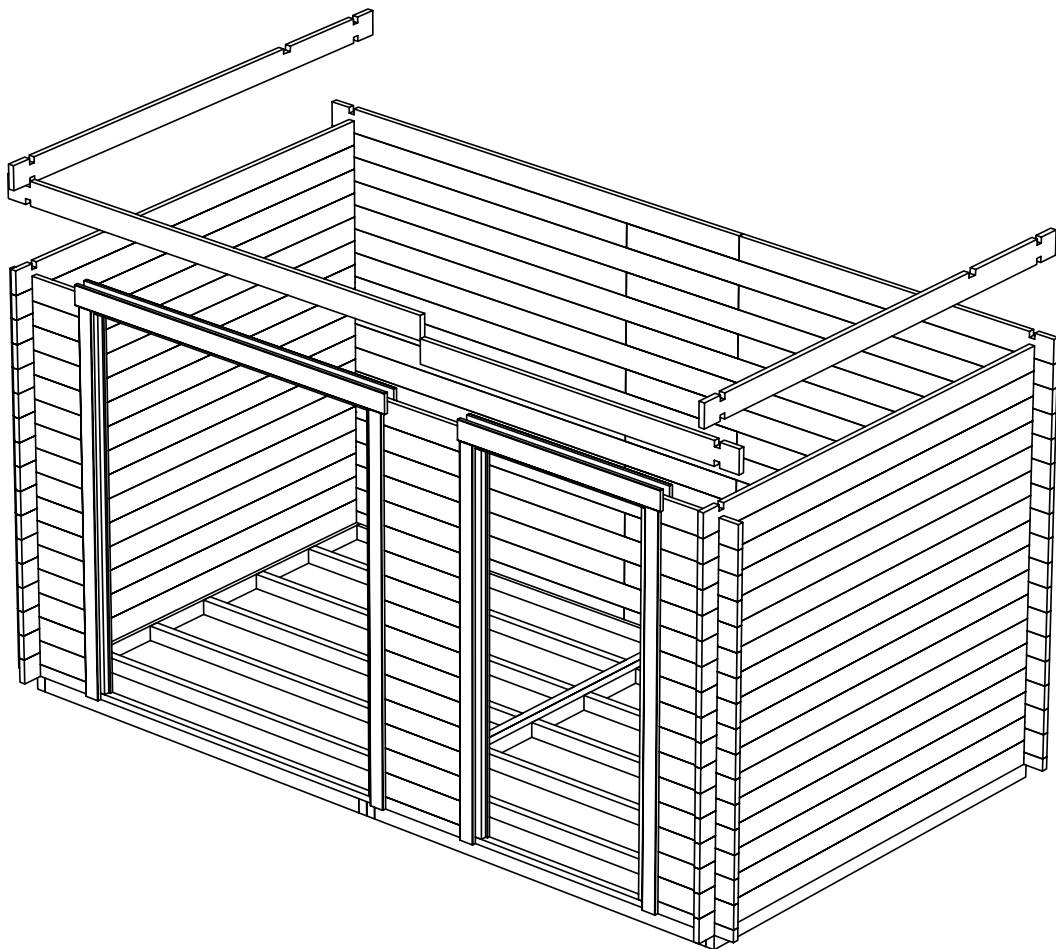
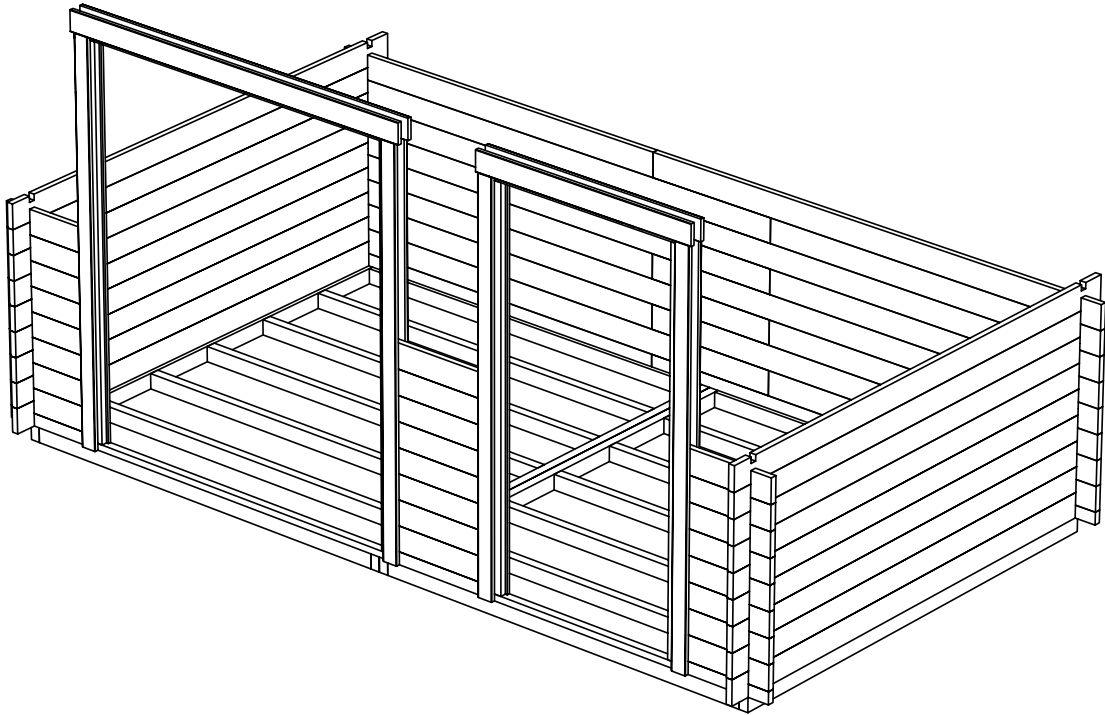

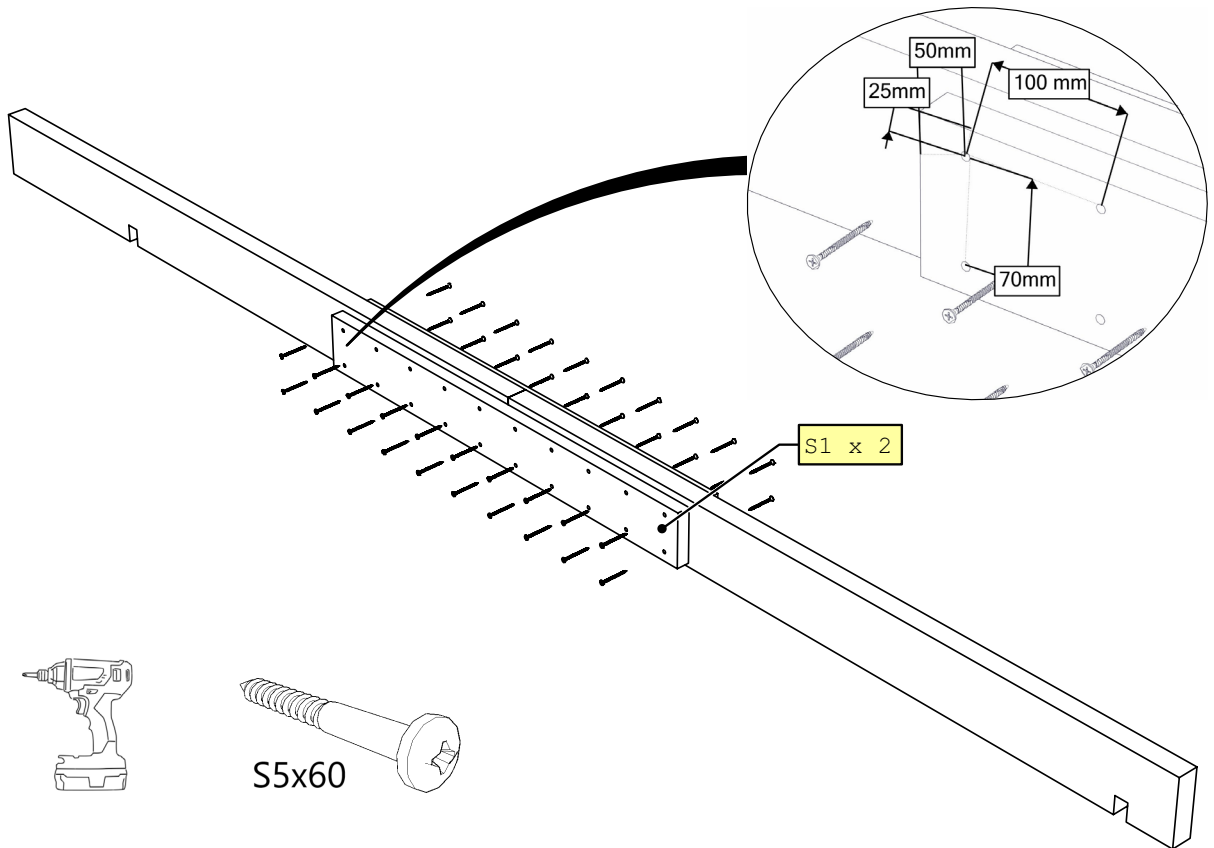
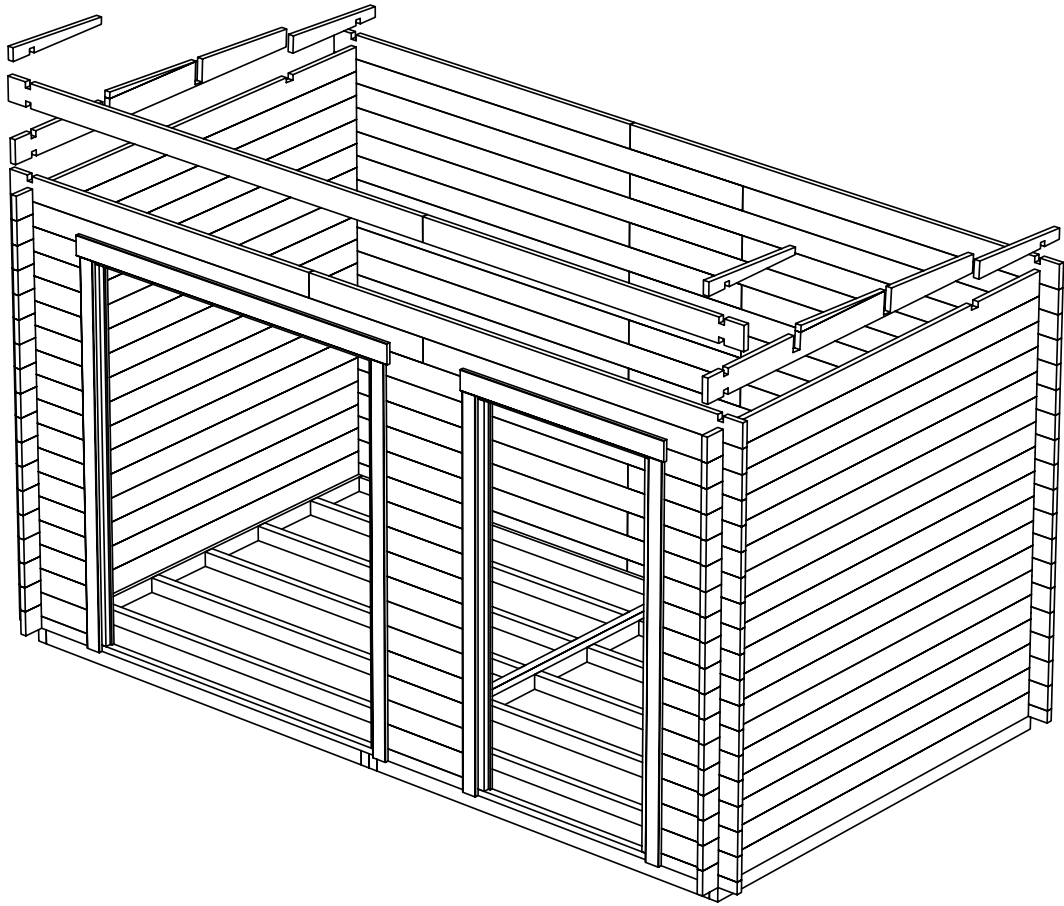

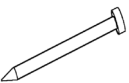
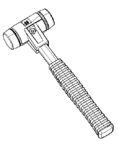
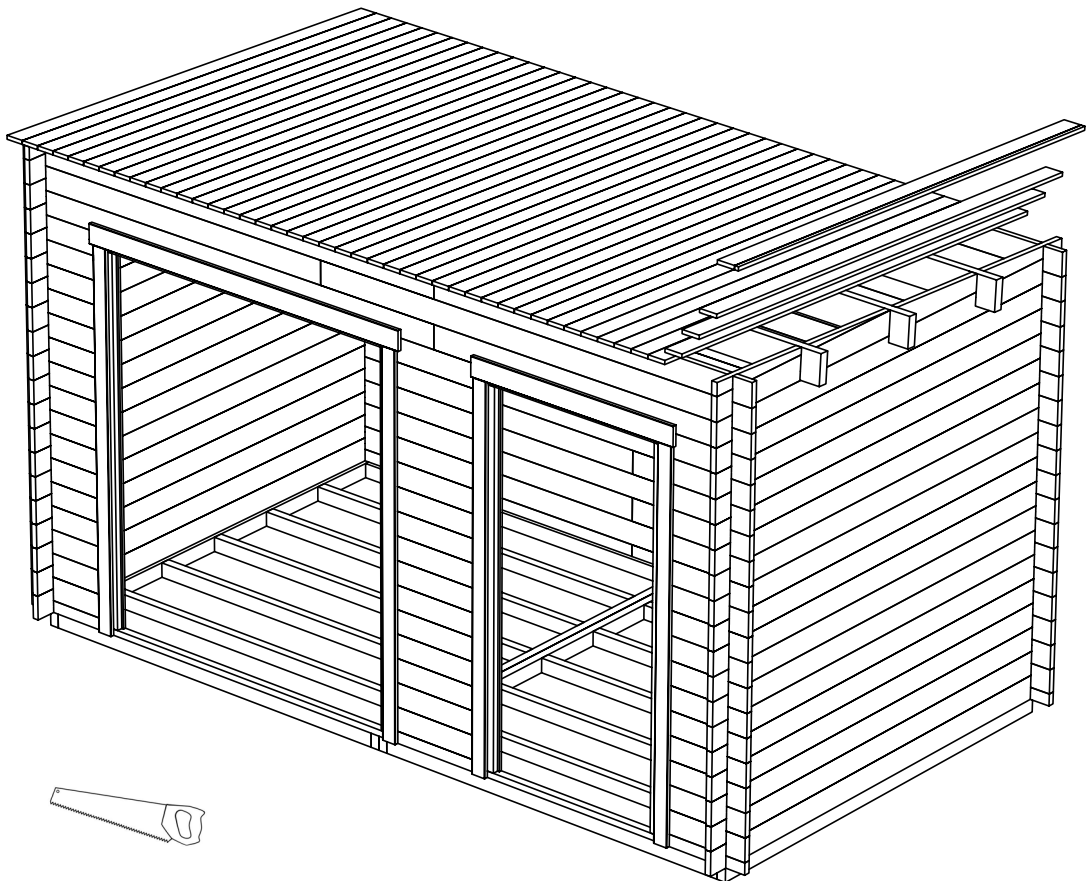
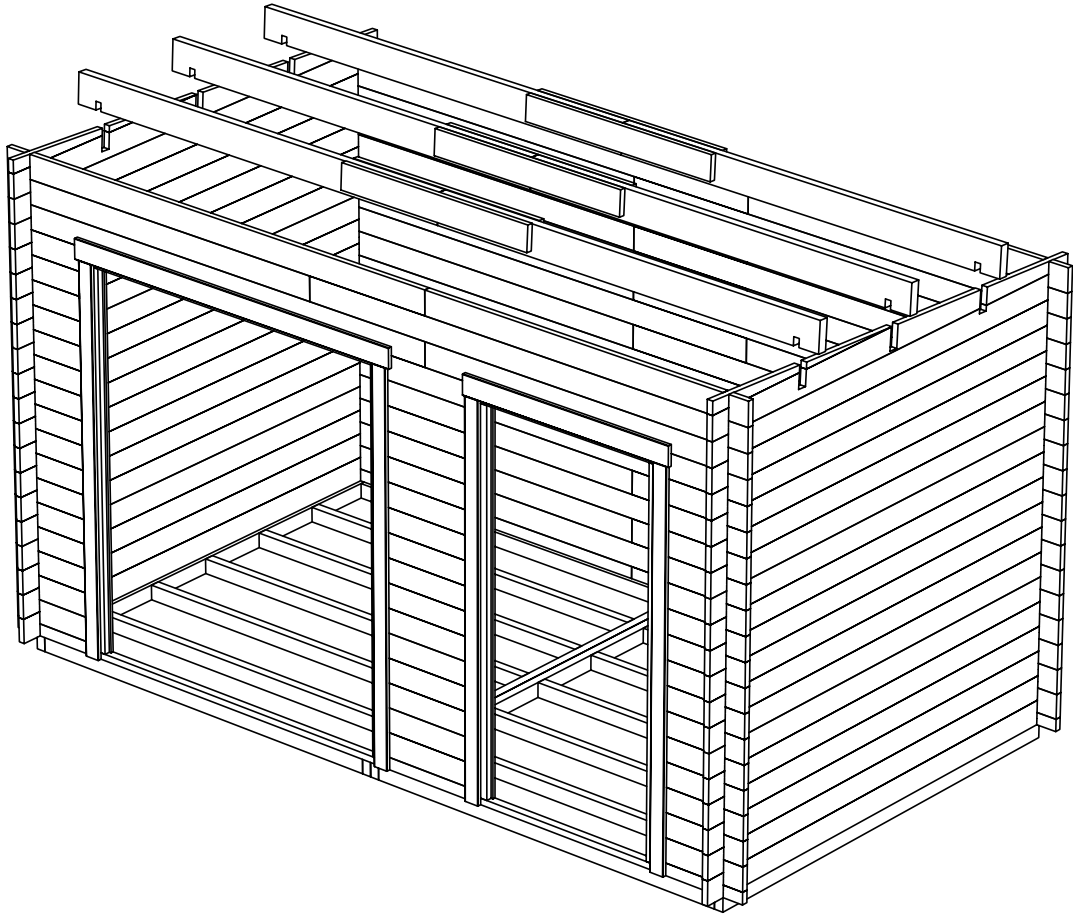

N1,8x40

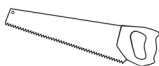

5

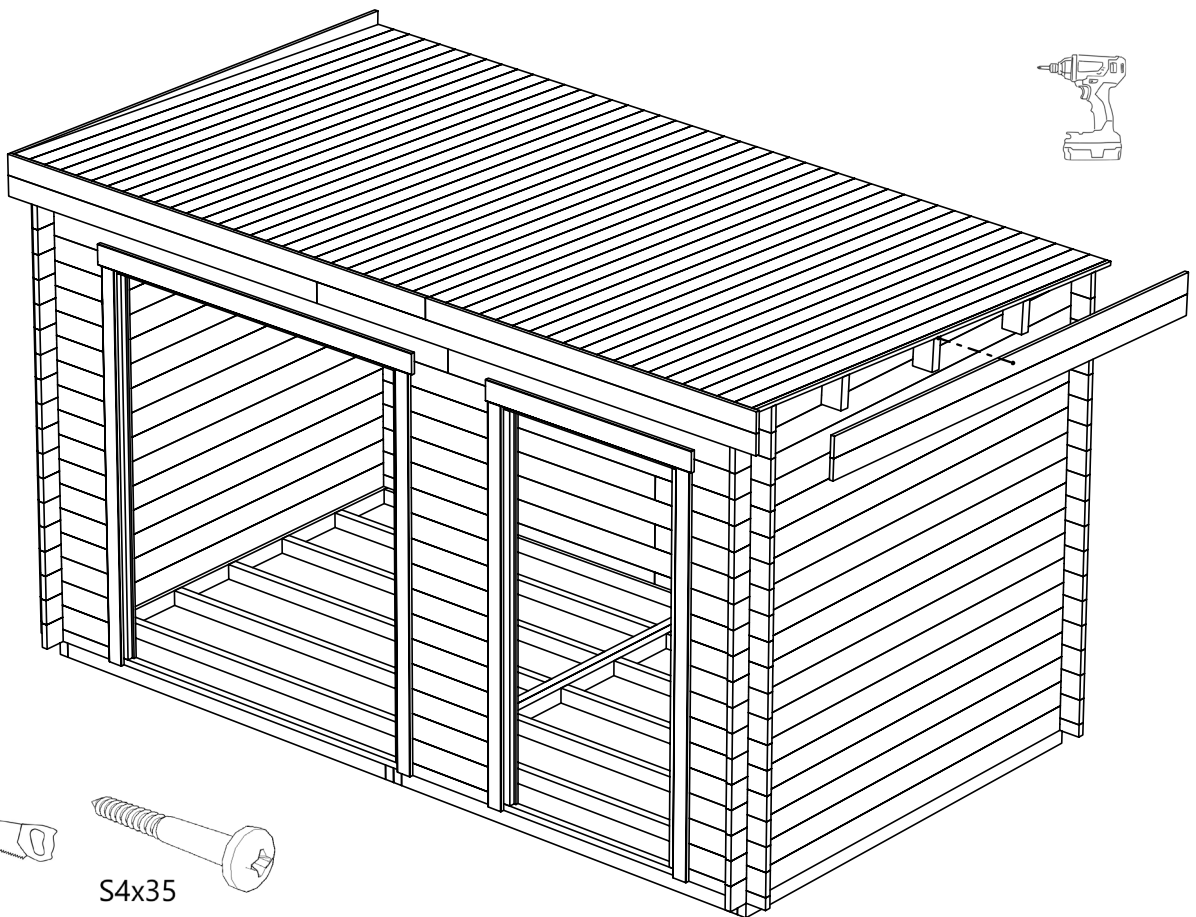
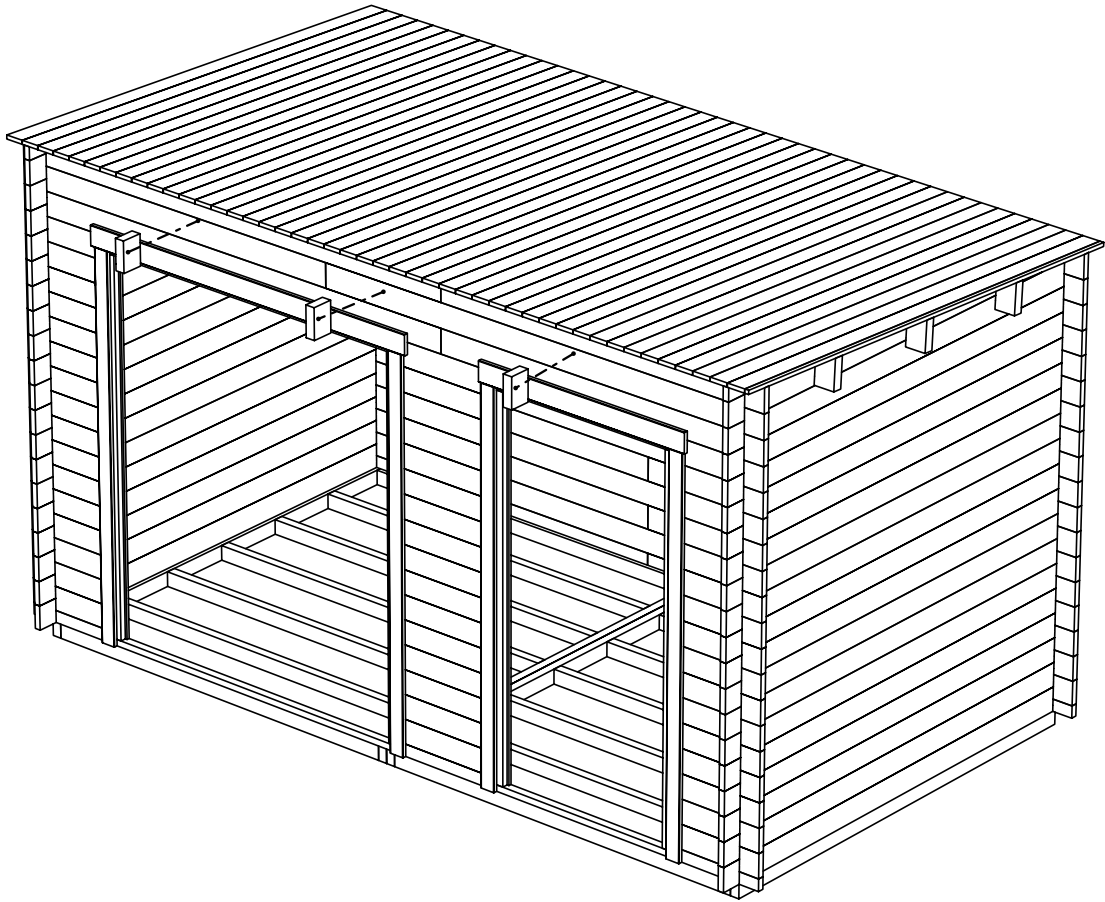

S4x35

6

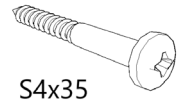
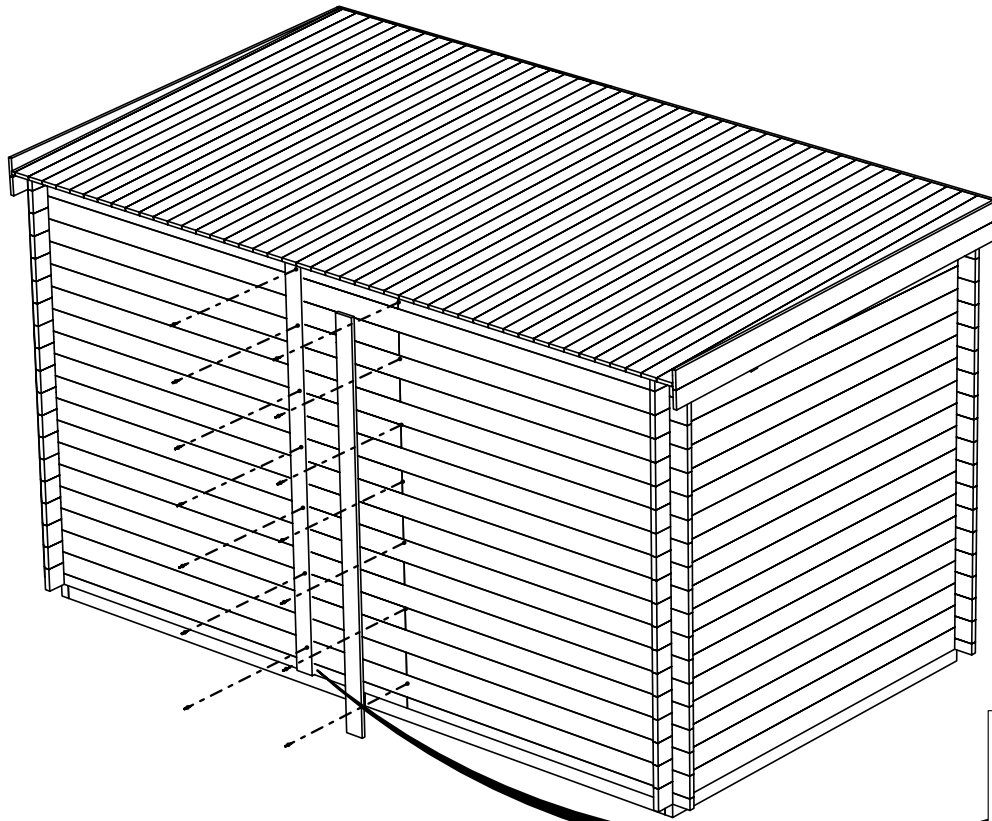



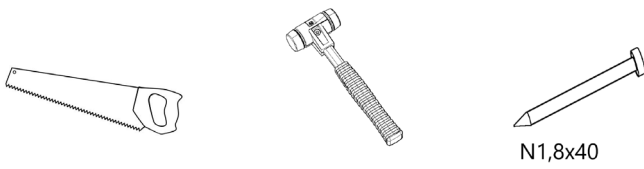
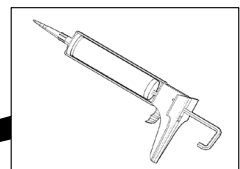
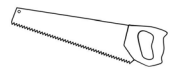



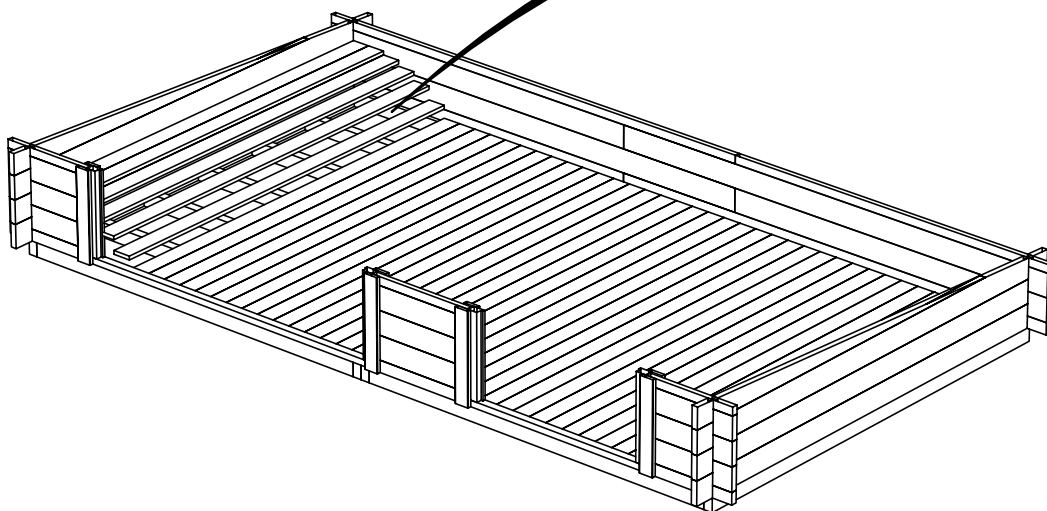
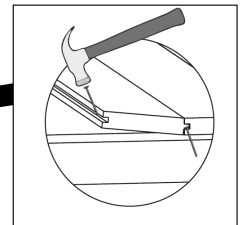

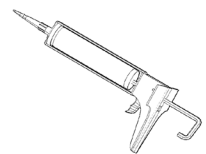
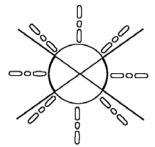
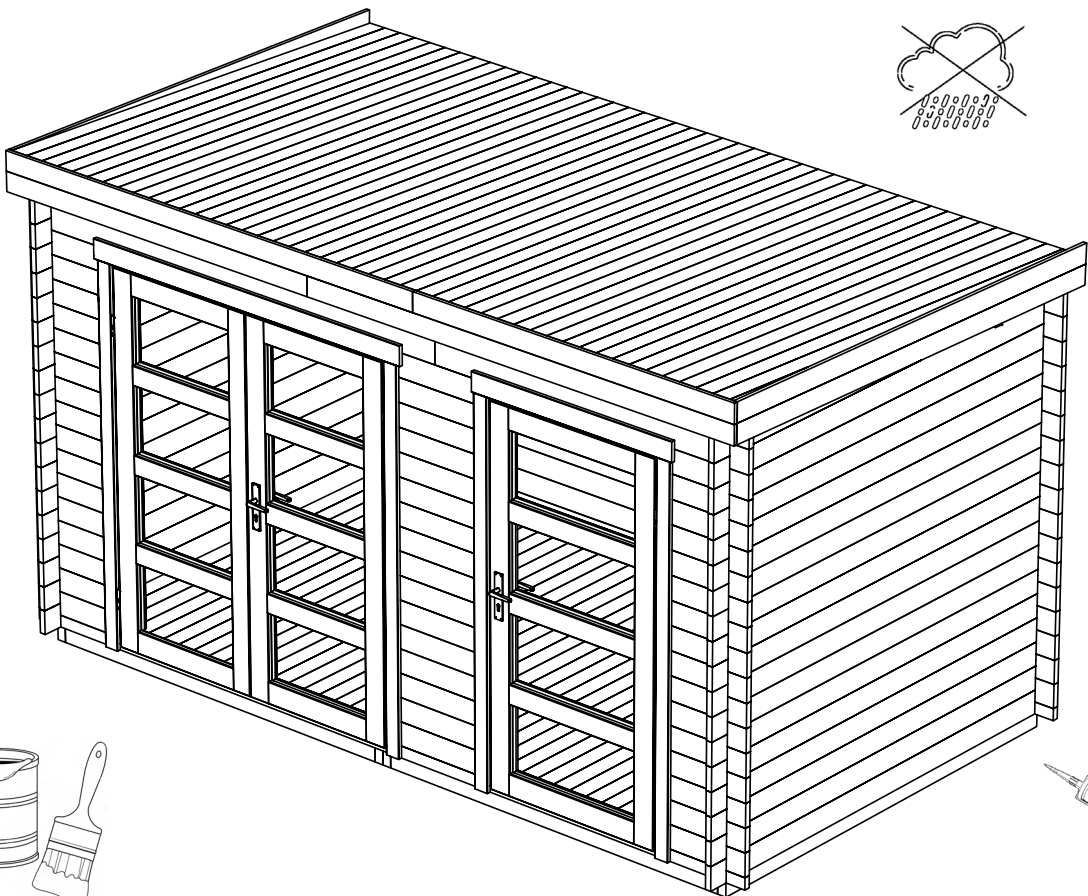
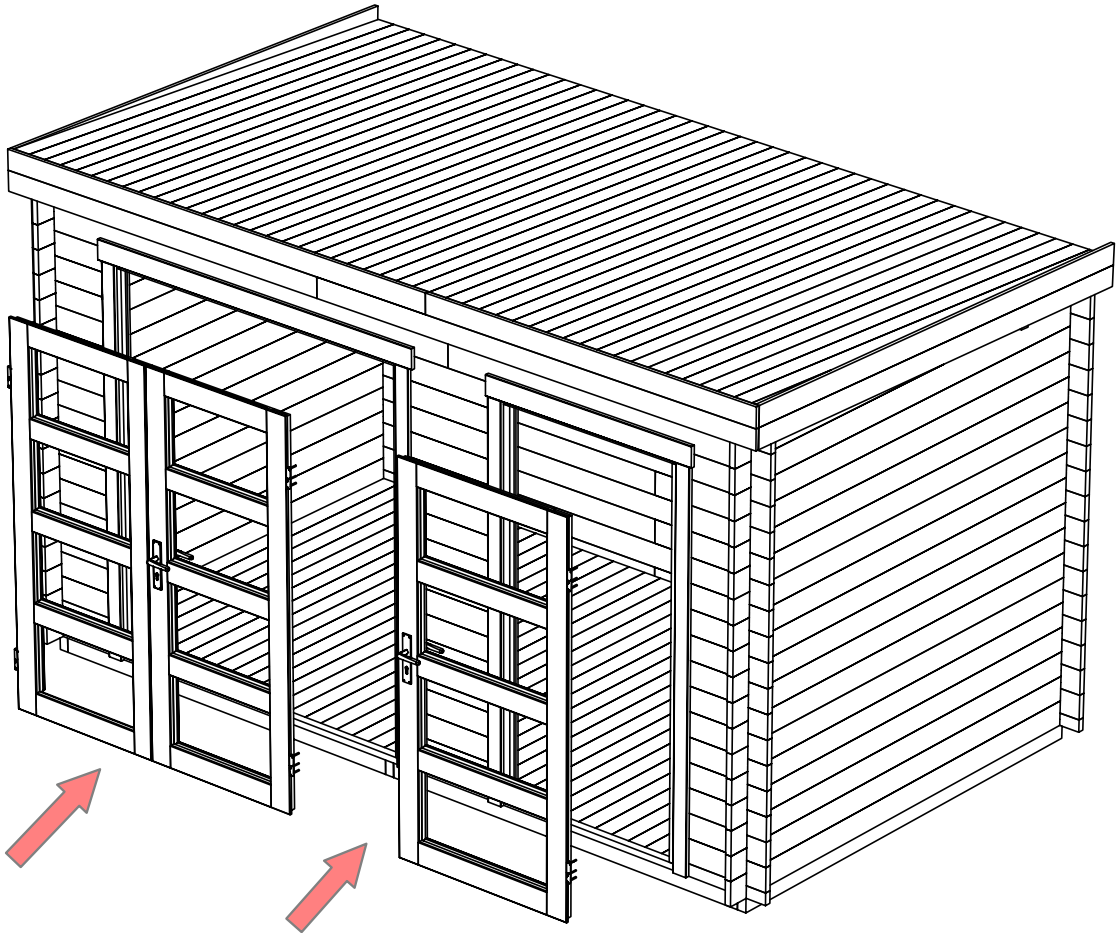

S4x35



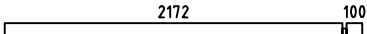
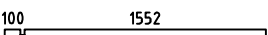
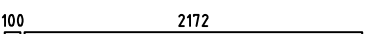
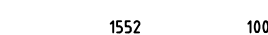

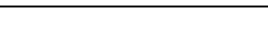
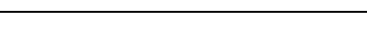
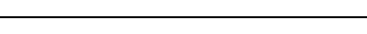
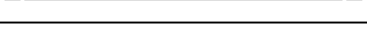
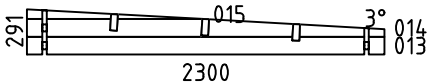
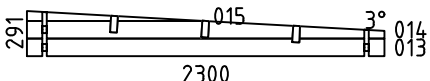



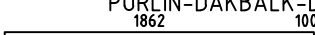

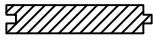
N1,8x40

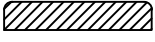

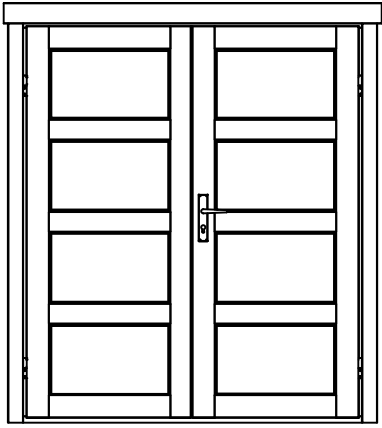
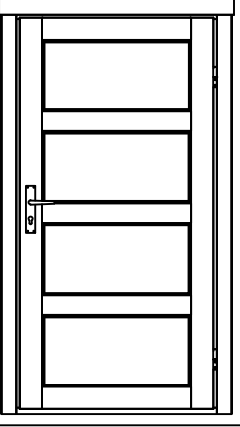

Pos	Specification-Spezifikation-Specificatie-Nomenclature-Elementi-Especificacion Pallet House flat 4x2,3	Qty	Profile (mm)	Lenght (mm)
001		2	28x57	450
002		1	28x57	515
003		32	28x114	450
004		16	28x114	515
005		19	28x114	2300
006		19	28x114	1680
007		1	28x114	2300
008		1	28x114	1680
009		1	28x57	1680
010		1	28x57	2300
011		1	28x114	1680
012		1	28x114	2300
013		34	28x114	2300
EXTRA1		1	28x114	2300
WA-1		1		
WB-1		1		
F1	FOUNDATION-FUNDAMENT-FONDATION-FONDAZIONE-VIGAS DE CIMENTACIÓN 	4	44x70	2090
F2	FOUNDATION-FUNDAMENT-FONDATION-FONDAZIONE-VIGAS DE CIMENTACIÓN 	14	44x70	1797
CS1	CORNICE SUPPORT-TRAGELEISTE-STEUNEN BAR-SUPPORT-SUPPORTO-SOPORTE 	2	44x144	100
S1	SUPPORT-STÜTZEN-STEUN-SUPPORT-SUPPORTO-SOPORTE 	6	28x120	1000
PL1	PURLIN-DAKBALK-DACHPFETTE-PANNE-ARCARECCIO-CORREA 	6	44x144	1990
Model	Pallet House flat 4x2,3	Material	Page 1/2	

Pos	Specification-Spezifikation-Specificatie-Nomenclature-Elementi-Especificacion Pallet House flat 4x2,3	Qty	Profile (mm)	Lenght (mm)	
F-1	Floor board-Fussbodenbrett-Vloerplank-Lame de plancher-Tavola pavimento-Tabla de suelo		43	88x18	2034
			33	114x18	
R-1	Roof board-Dachbrett-Dakplank-Volige-Tavola tetto-Tabla de tejado		46+1	88x18	2305
			35+1	114x18	
GB-1	Gable board 95-Giebelblende-Gevelplank-Planche de rive-Tavola di bordo-Tabla de borde		10	18x95	2300
GB-2	Gable board 95-Giebelblende-Gevelplank-Planche de rive-Tavola di bordo-Tabla de borde		10	18x95	2340
	Double door kit ISO-Doppeltür satz-Dubbele deur set-Kit double porte-Kit porta-Kit para puerta		1		
	Nail 1.8x40-Nagel-Spijker-Clou-Chiodo-Clavo		630	1.8x40	
S4x35	Screw 4x35-Schraube-Schroef-Vis-Vite-Tornillo		50	4x35	
S5x60	Screw 5x60-Schraube-Schroef-Vis-Vite-Tornillo		60	5x60	
S5x80	Screw 5x80-Schraube-Schroef-Vis-Vite-Tornillo		70	5x80	
S6x120	Screw 6x120-Schraube-Schroef-Vis-Vite-Tornillo		5	6x120	
	DOOR 1600x1850 DD4B F 1600x1850-28		1		
	DOOR 945x1850 SD4B F 945x1850-28 R		1		
Model	Pallet House flat 4x2,3	Material	Page	2/2	

H = 1.600 m
 TOTAL: 7.61 m²

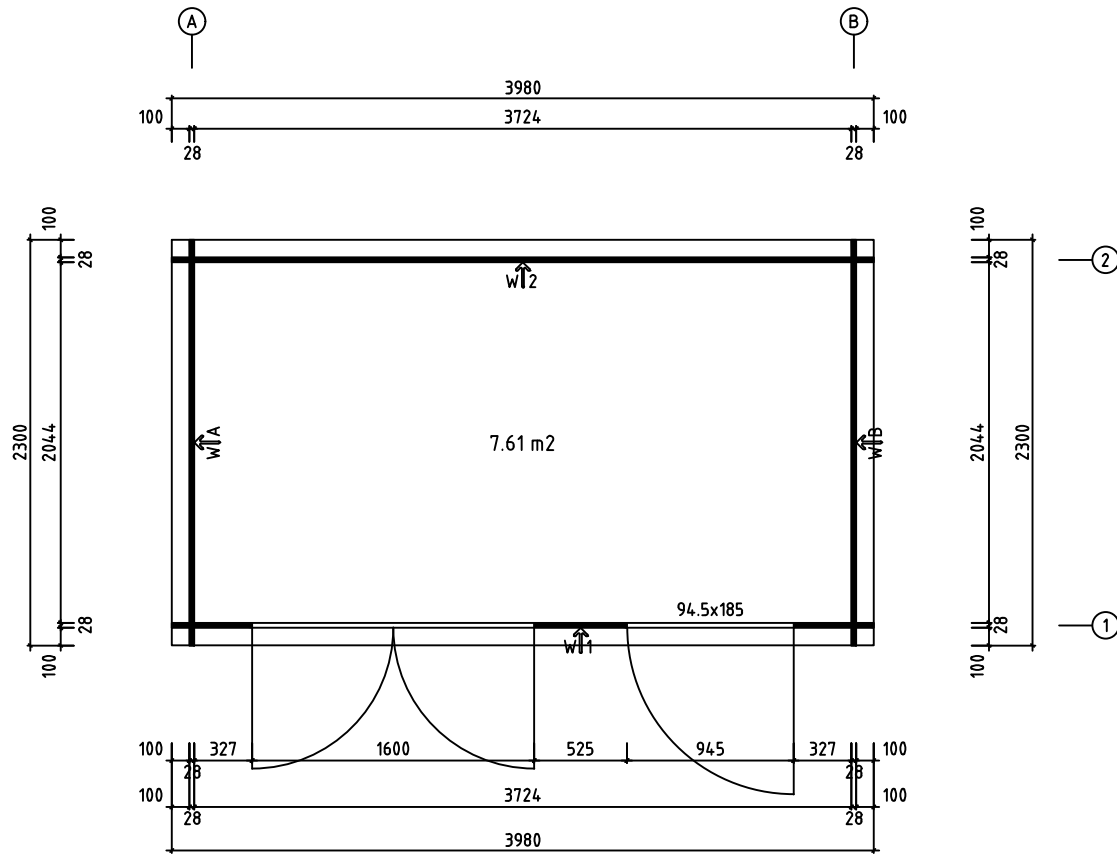

Model	Pallet House flat 4x2,3	Page
Drawing	PLAN	Scale 1:30
Material	28x114	Date 08.07.2024
File	Pallet House Flat 4x2,3.dwg	Drawn by T.T

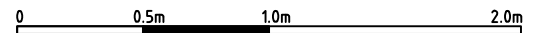
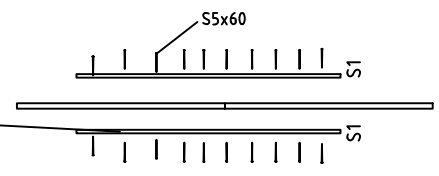
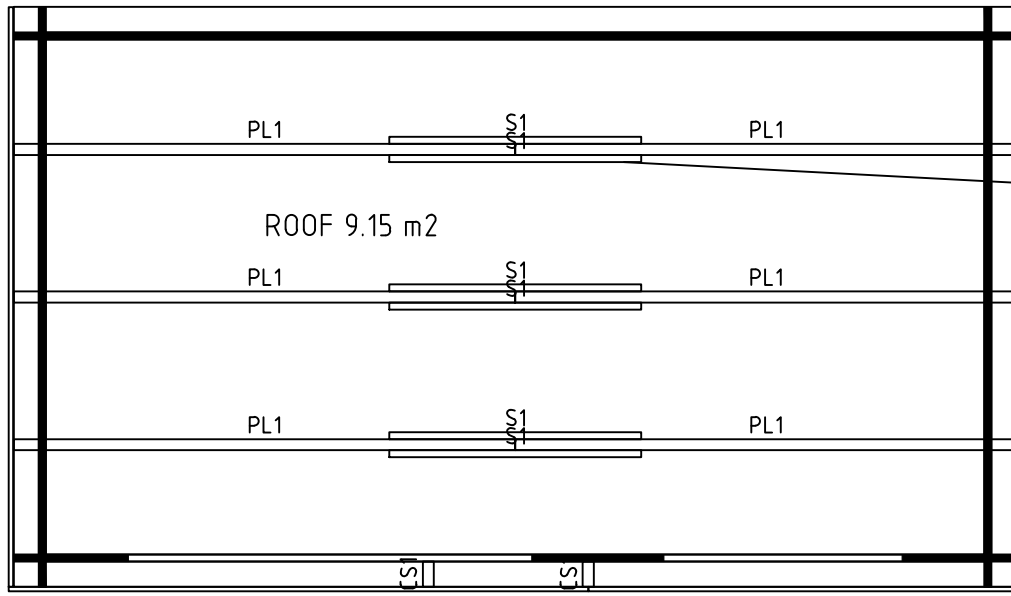

Model	Pallet House flat 4x2,3	Page
Drawing		Scale 1:30
Material	28x114	Date 08.07.2024
File	Pallet House Flat 4x2,3.dwg	Drawn by T.T

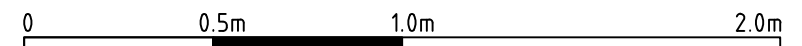
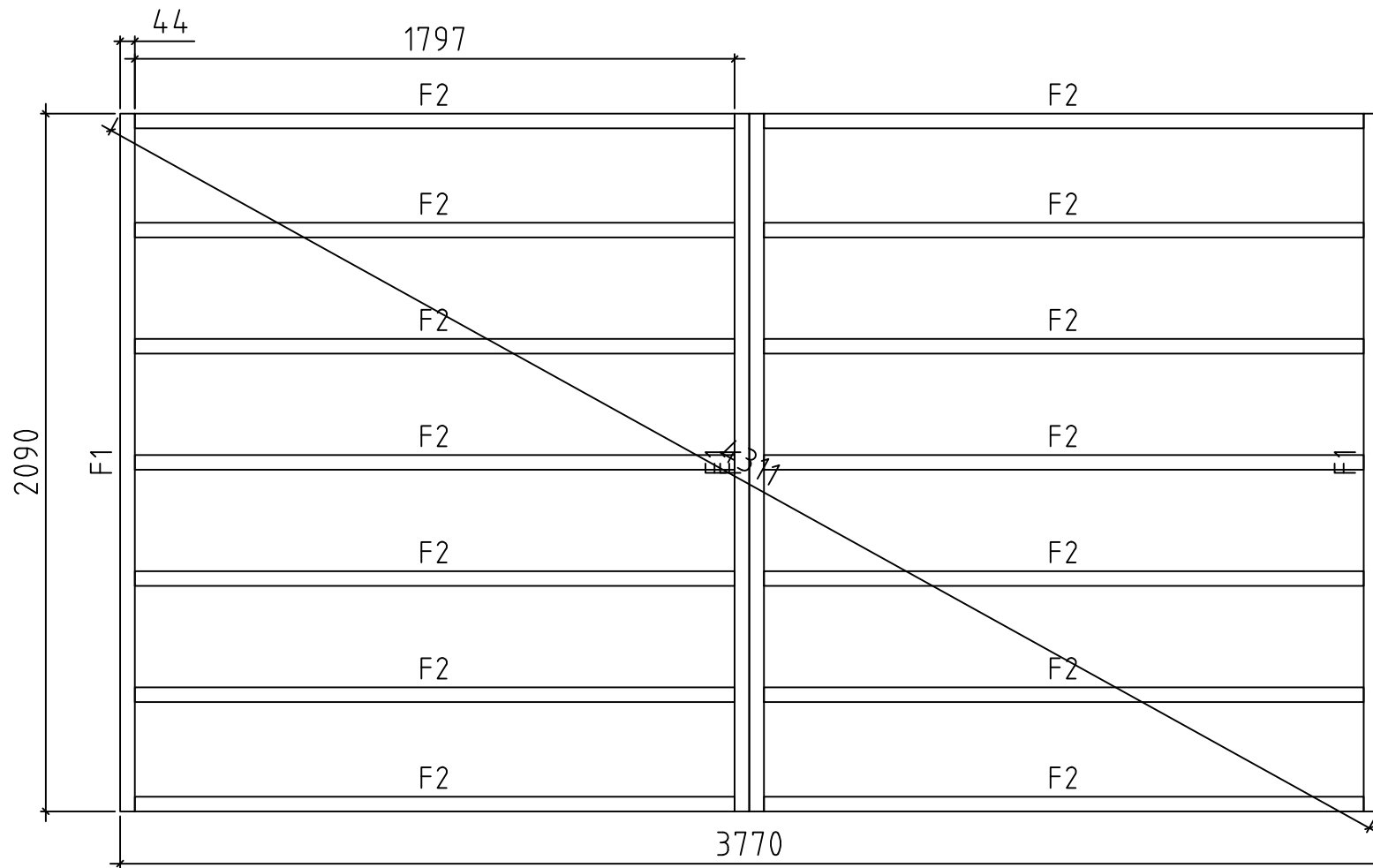

Model	Foundation	Page
Drawing		Scale 1:20
Material		Date 08.07.2024
File	Pallet House Flat 4x2,3.dwg	Drawn by T.T

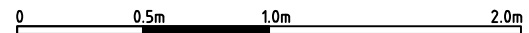
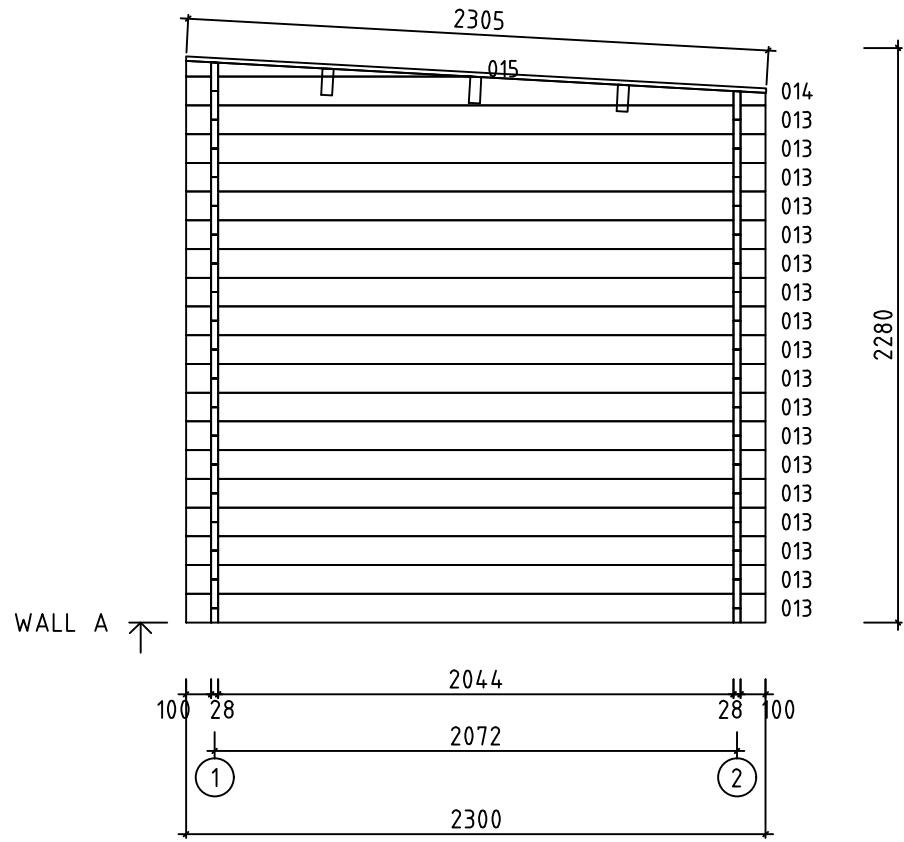

Model	Pallet House flat 4x2,3	Page	3
Drawing	WALL A	Scale	1:30
Material	2.8x11.4	Date	08.07.2024
File	Pallet House Flat 4x2,3.dwg	Drawn by	T.T

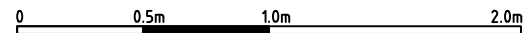
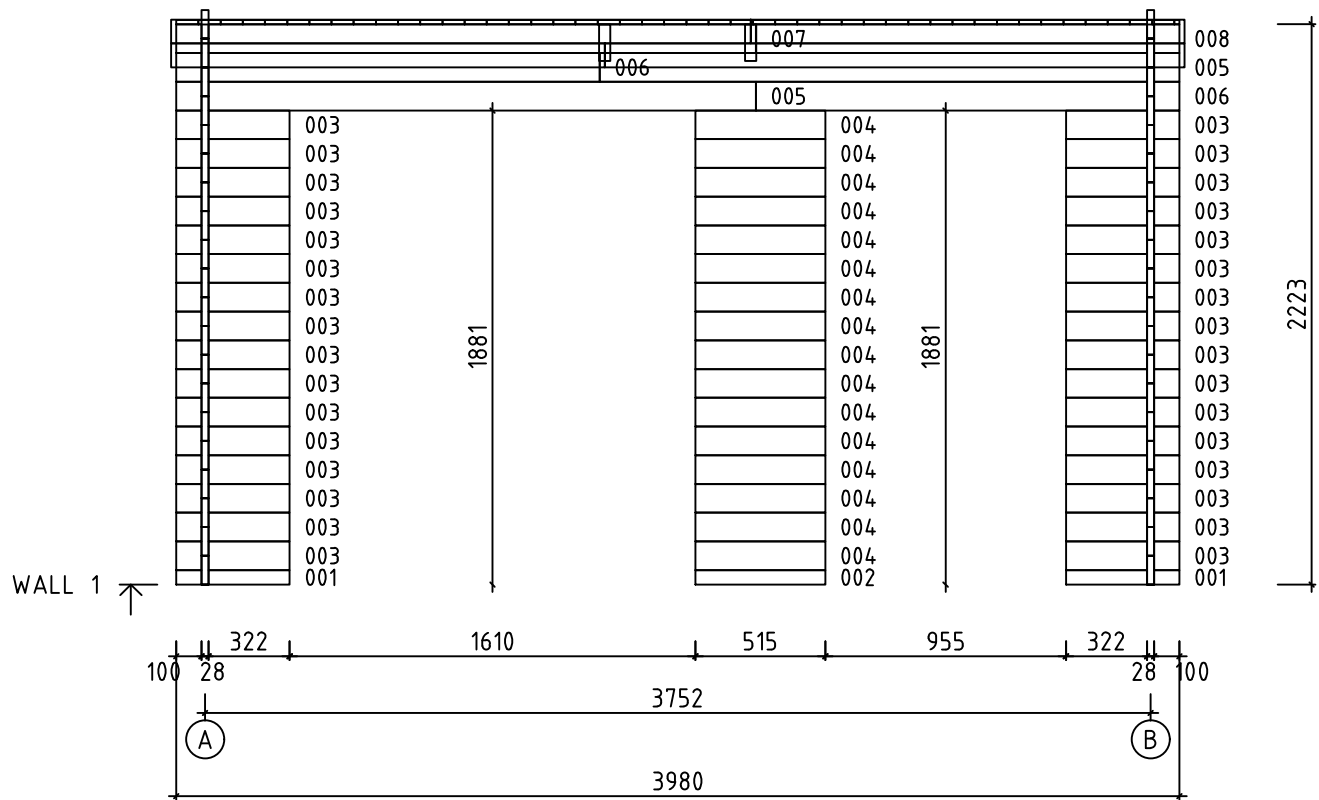

Model	Pallet House flat 4x2,3	Page	5
Drawing	WALL 1	Scale	1:30
Material	2.8x11.4	Date	08.07.2024
File	Pallet House Flat 4x2,3.dwg	Drawn by	T.T

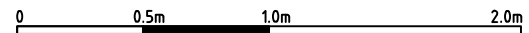
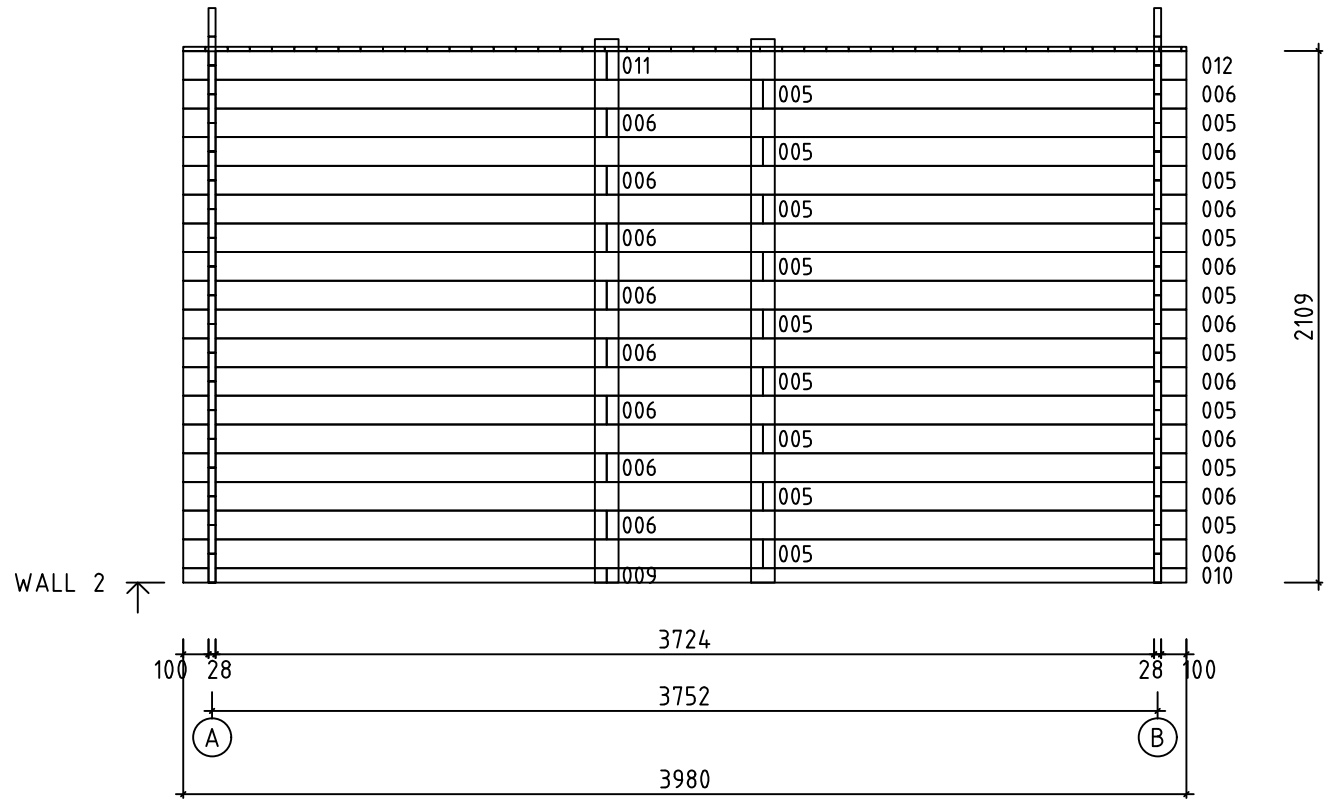

Model	Pallet House flat 4x2,3	Page	6
Drawing	WALL 2	Scale	1:30
Material	2.8x11.4	Date	08.07.2024
File	Pallet House Flat 4x2,3.dwg	Drawn by	T.T