

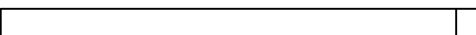

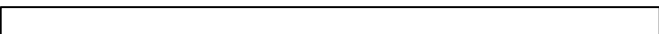

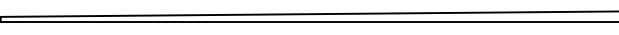

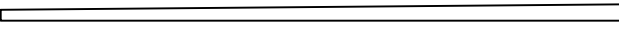

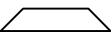
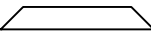



Carport Wohnmobil

Alphol 

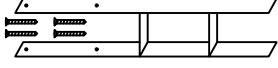
Pos	Specification-Spezifikation-Specificatie-Nomenclature-Elementi-Especificacion Alpholz Wohnmobil Carport	Qty	Profile (mm)	Lenght (mm)
RT2	RAFTER-SPARREN-DAKSPAR-CHEVRON-TRAVE-CABRIO 	2	70x195	5050
RT1	RAFTER-SPARREN-DAKSPAR-CHEVRON-TRAVE-CABRIO 	2	70x195	3074
PL1	PURLIN-DAKBALK-DACHPFETTE-PANNE-ARCARECCIO-VIGUETA DE TEJADO 	9	70x195	4240
B1	BEAM-HOLZBALKEN-BALKEN-POUTRE-TRAVE-VIGA 	2	70x69	3990
B2	BEAM-HOLZBALKEN-BALKEN-POUTRE-TRAVE-VIGA 	2	70x105	3990
DG1	DIAGONAL-DIAGONAAL-DIAGONALE-DIAGONAL 	24	70x144	707
DG2	DIAGONAL-DIAGONAAL-DIAGONALE-DIAGONAL 	24	50x144	983
R-1	Roof board-Dachbrett-Dakplank-Volige-Tavola tetto-Tabla de tejado 	49+1 38+1	88x18 114x18	4970
R-2	Roof board-Dachbrett-Dakplank-Volige-Tavola tetto-Tabla de tejado 	49 38	88x18 114x18	3010
	-POST 12x12 	8	120x120	3700
GB-1	Gable board 120-Giebelblende-Gevelplank-Planche de rive-Tavola di bordo-Tabla de borde 	8	18x120	3990
GB-2	Gable board 120-Giebelblende-Gevelplank-Planche de rive-Tavola di bordo-Tabla de borde 	4	18x120	4280
	Angle bracket 90x40-Winkelhalterungen-Hoekverbinder-Équerre d'angle-Staffa angolare-Soporte angular 	18	90x40	
C10x160	Coach screw kit 10x160-Holzschraube-Houtdraadbout-Tirefond-Vite tirafondo-Tornillo entrenador 	8	10x160	
	Nail 1.8x40-Nagel-Spijker-Clou-Chiodo-Clavo 	600	1.8x40	
	Post foot Kit 	8		
S4x60	Screw 4x60-Schraube-Schroef-Vis-Vite-Tornillo 	200	4x60	
S6x120	Screw 6x120-Schraube-Schroef-Vis-Vite-Tornillo 	120	6x120	
S6x200	Screw 6x200-Schraube-Schroef-Vis-Vite-Tornillo 	160	S6x200	
Kood	Alpholz Wohnmobil Carport	Materjal	File	WohnmobilCarport.dwg
			Leht	1/1

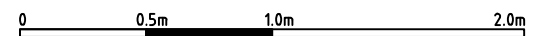
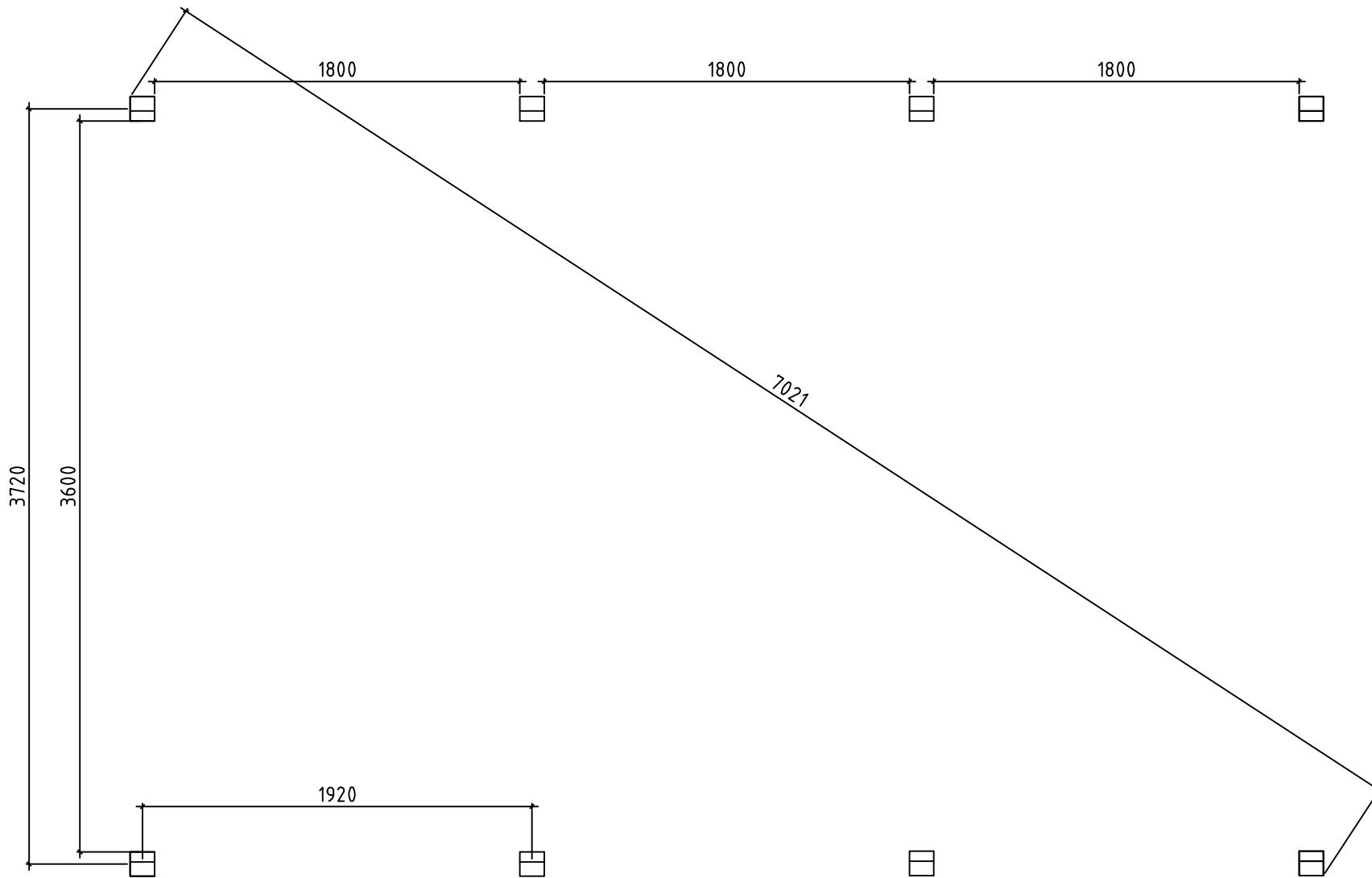

Model	Alpholz Wohnmobil Carport	Page	
Client	POSTS	Scale	1:30
Material		Date	22.01.2026
Company		File	WohnmobilCarport.dwg

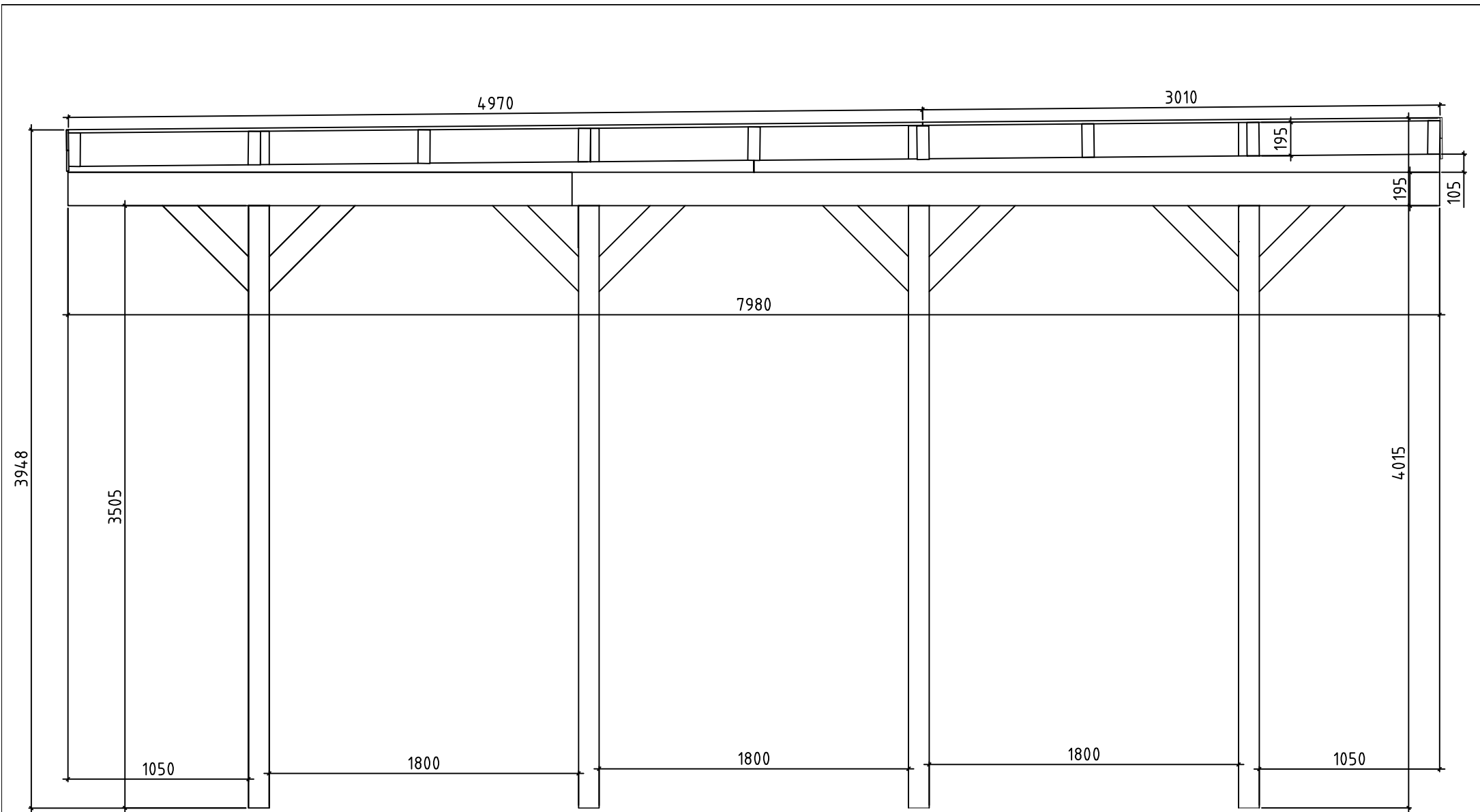

Model	Alpholz Wohnmobil Carport	Page	
Client	SIDE	Scale	1:30
Material		Date	22.01.2026
Company	T.T	File	WohnmobilCarport.dwg

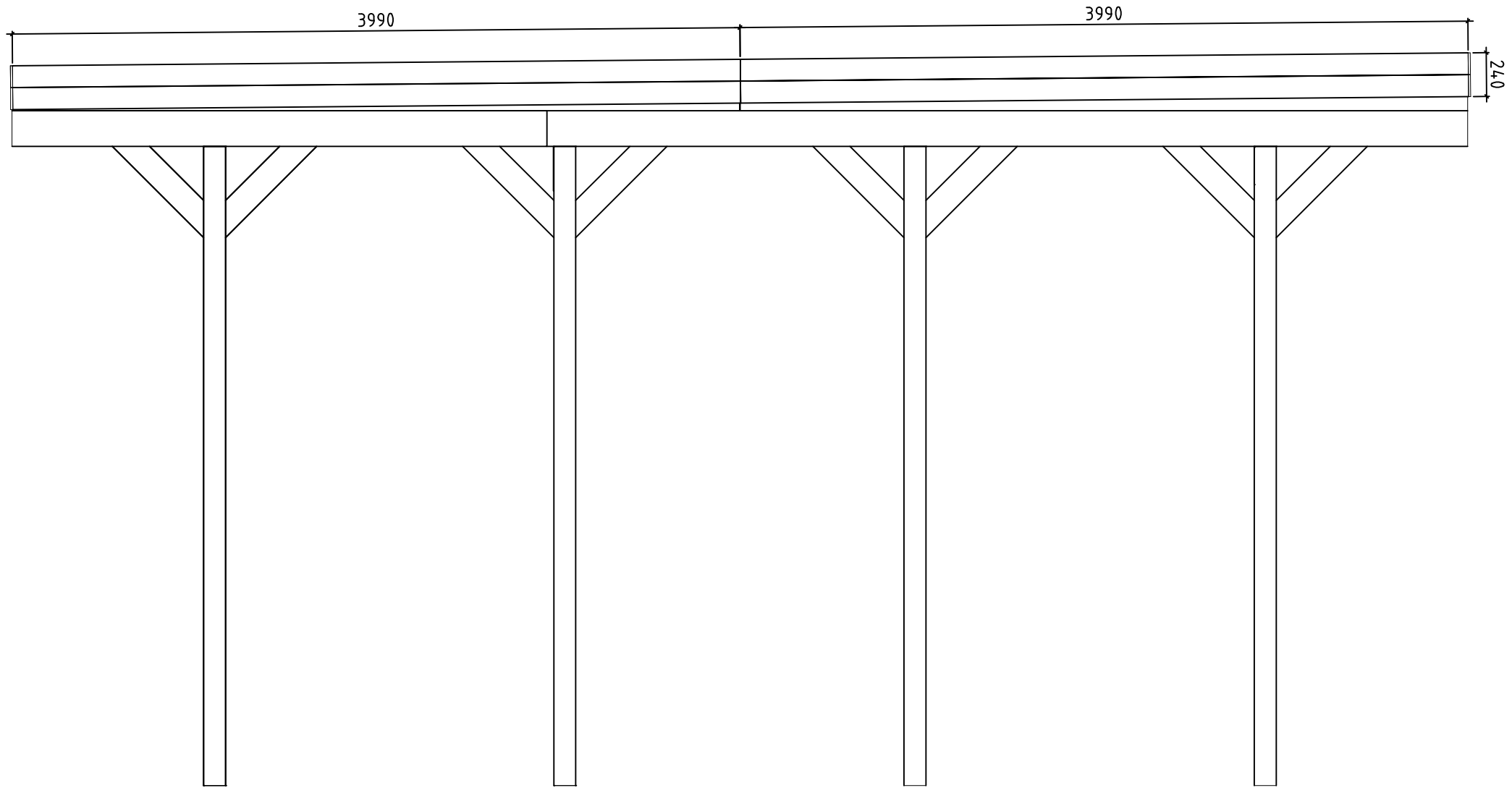

Model	Alpholz Wohnmobil Carport	Page	
Client	SIDE COVER	Scale	1:30
Material		Date	22.01.2026
Company	T.T	File	WohnmobilCarport.dwg

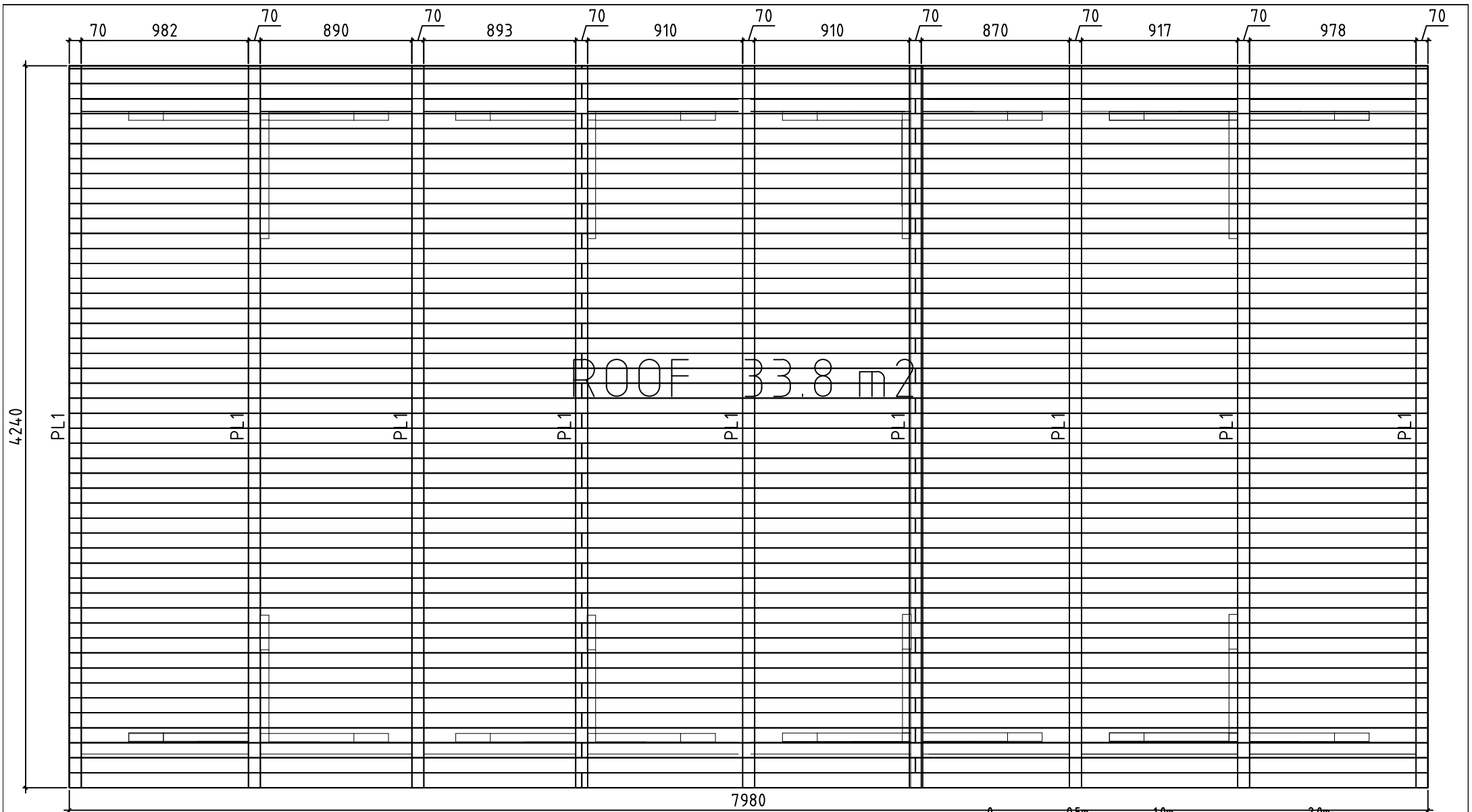

Model	Alpholz Wohnmobil Carport	Page	4
Client	WALL D	Scale	1:30
Material	7x13.5	Date	22.01.2026
Company	T.T	File	WohnmobilCarport.dwg

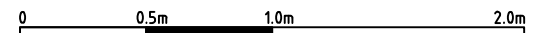
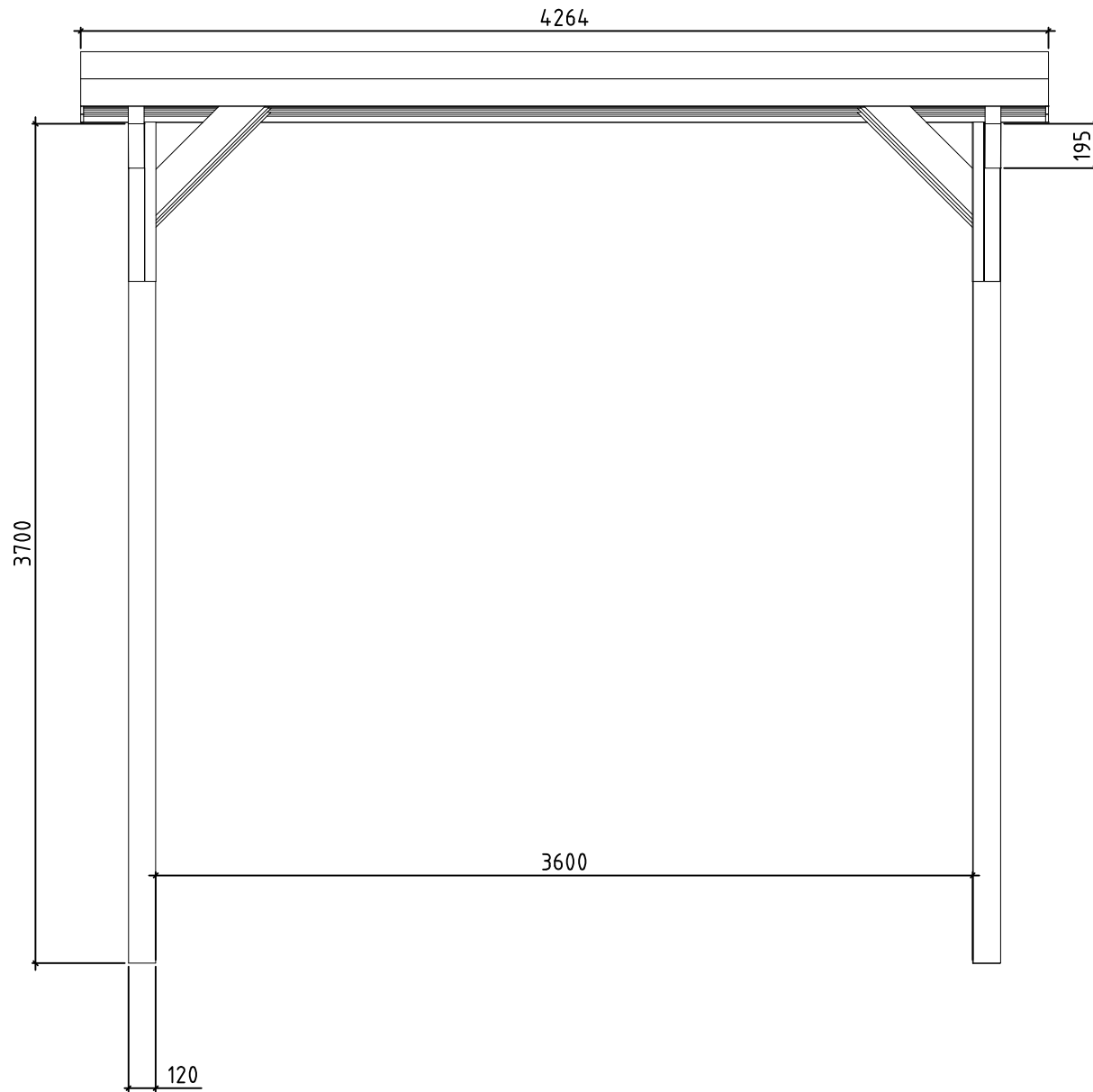

Model	Alpholz Wohnmobil Carport	Page	5
Client	WALL 3	Scale	1:30
Material	7x13.5	Date	22.01.2026
Company	T.T	File	WohnmobilCarport.dwg