

Alphol

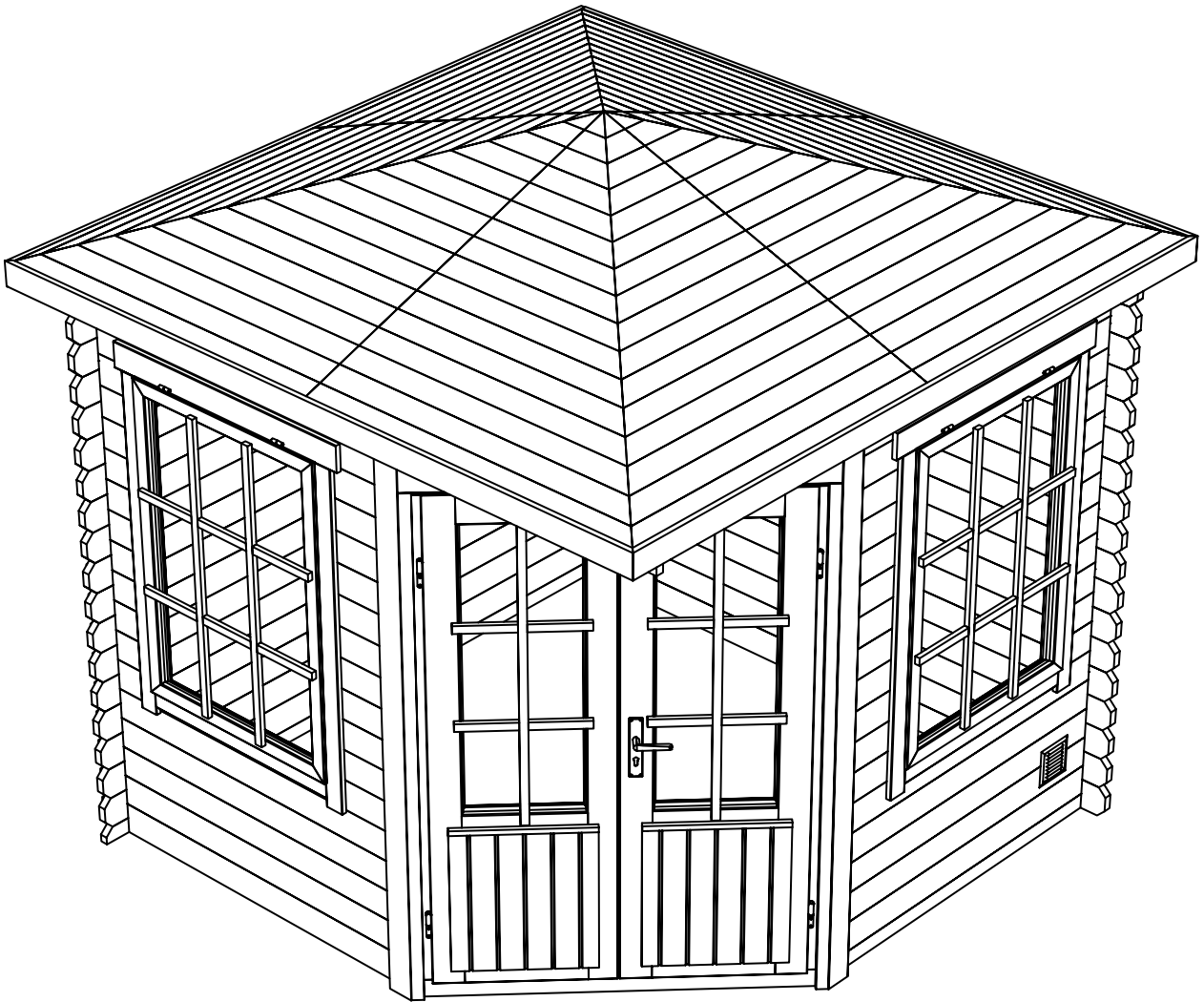

Sunny 28 C

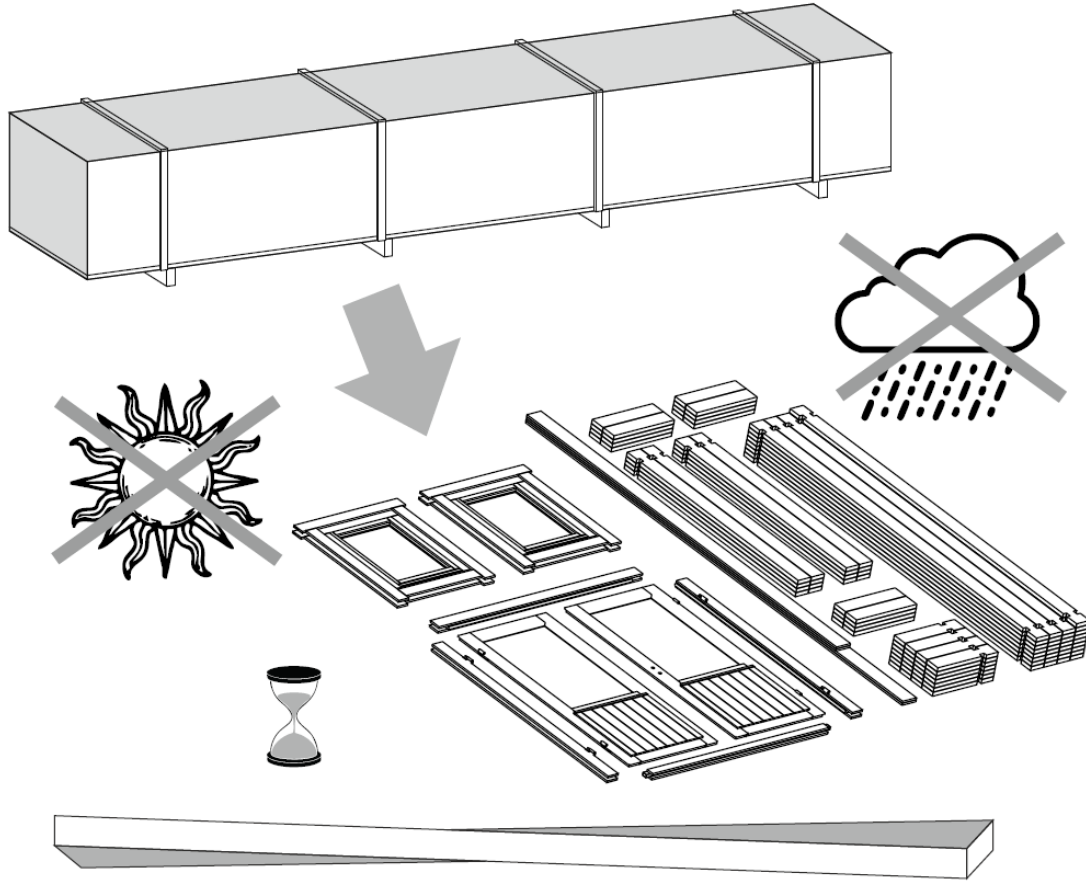

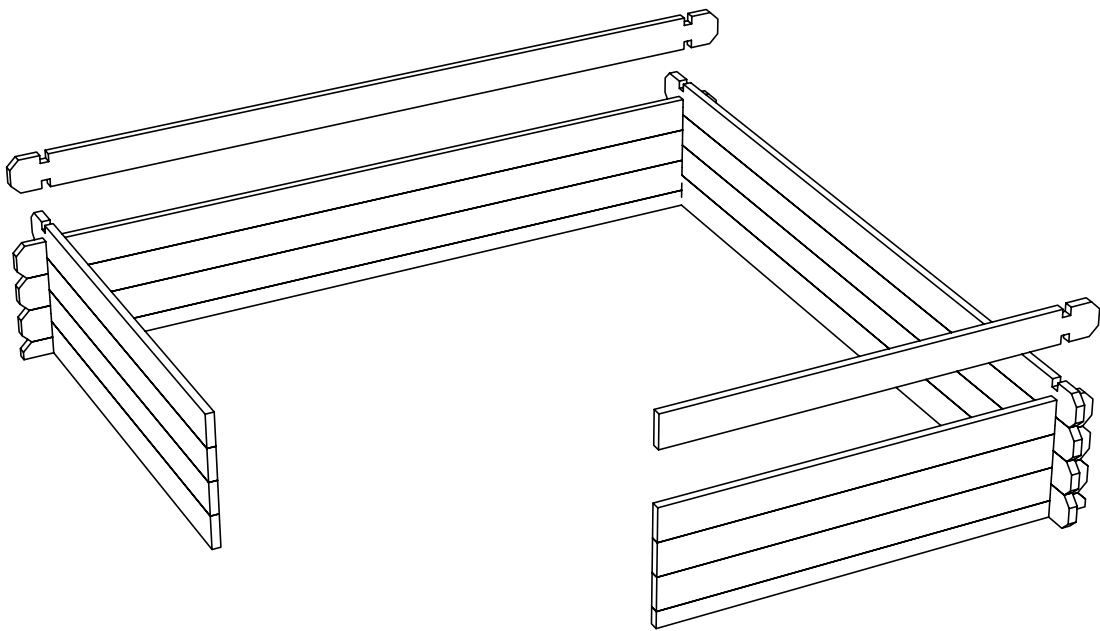
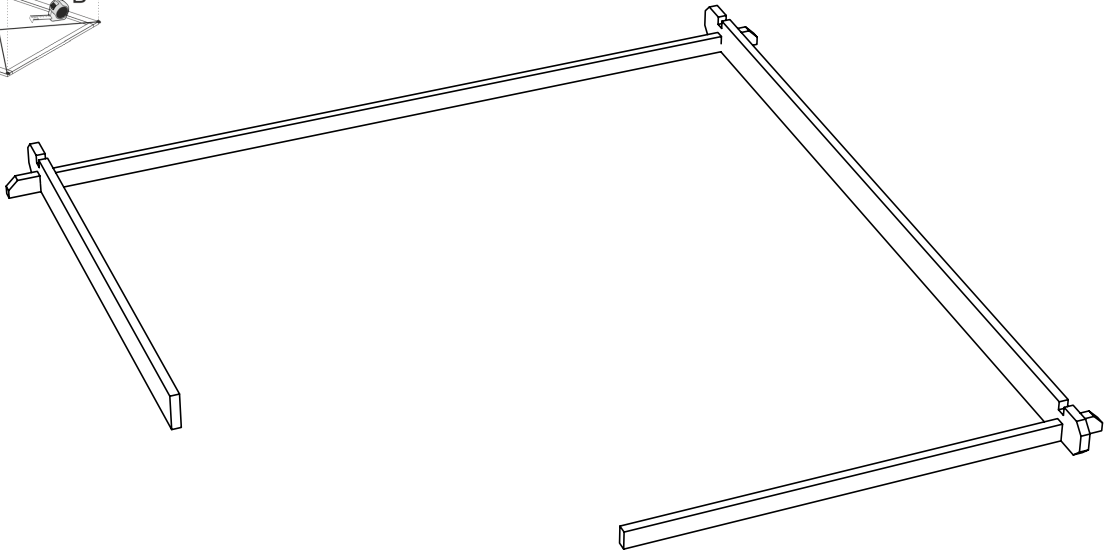
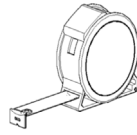
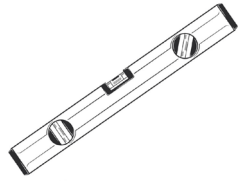
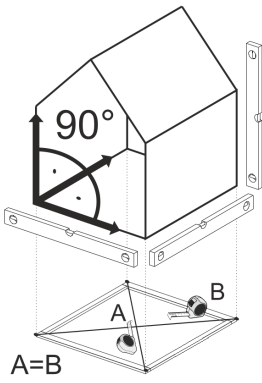

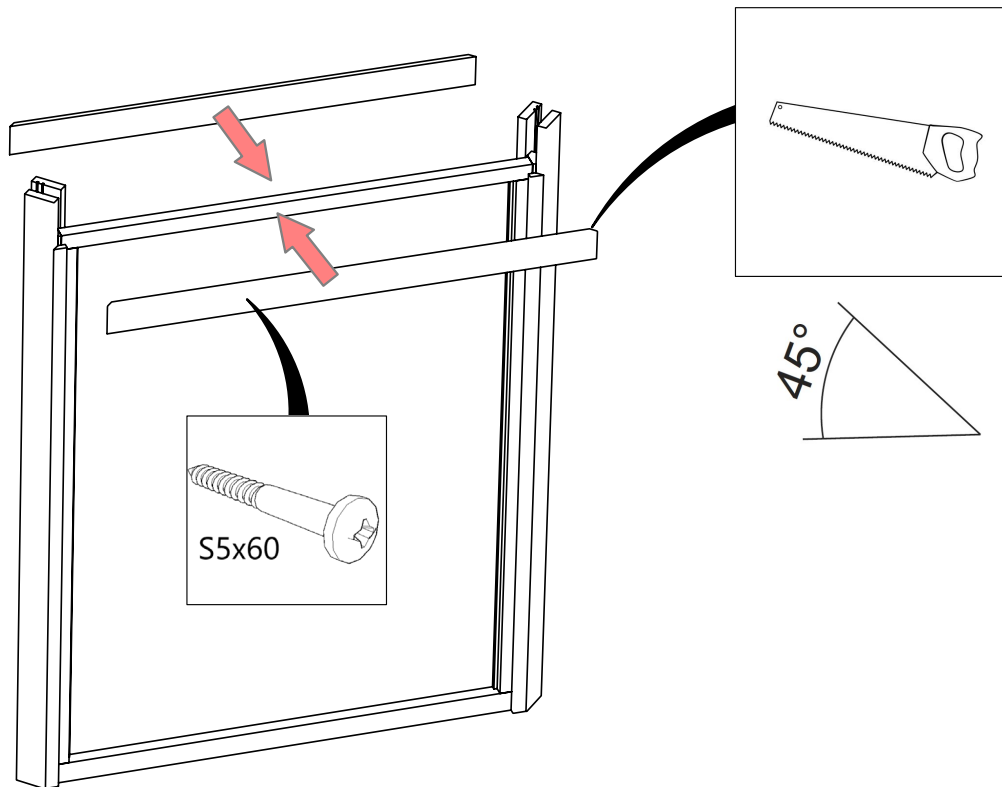
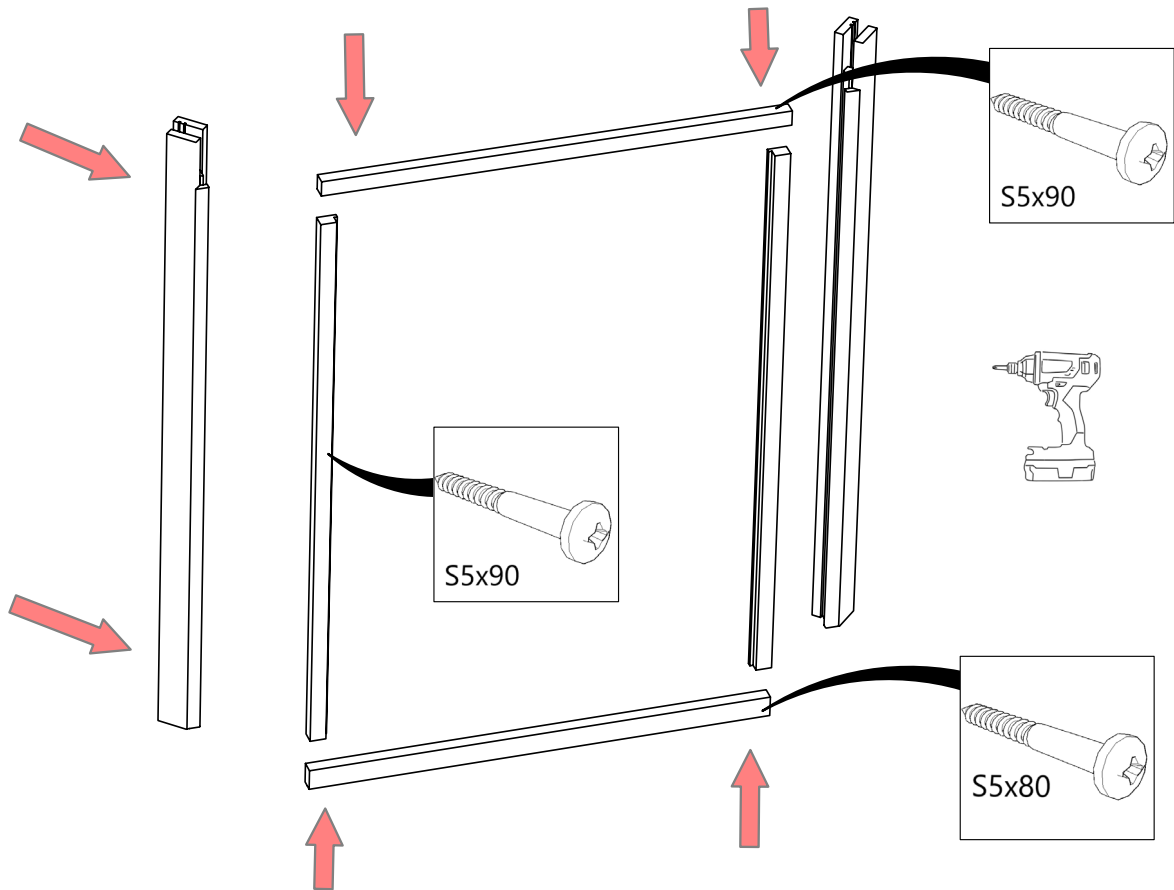

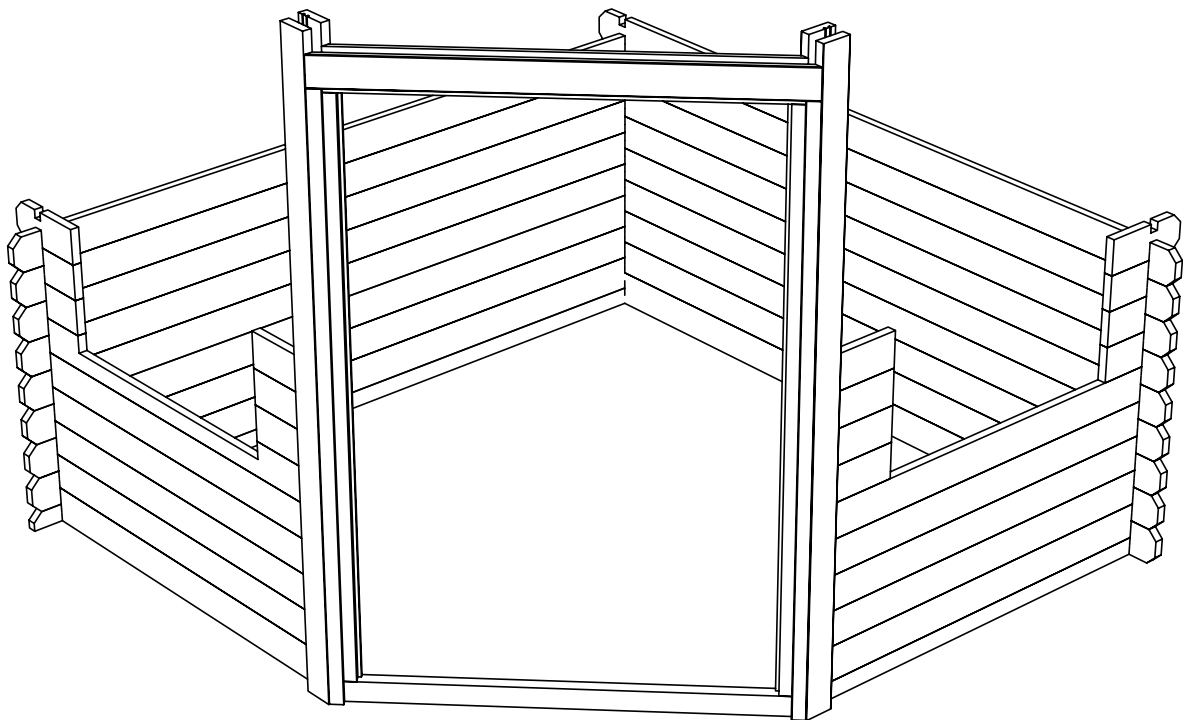
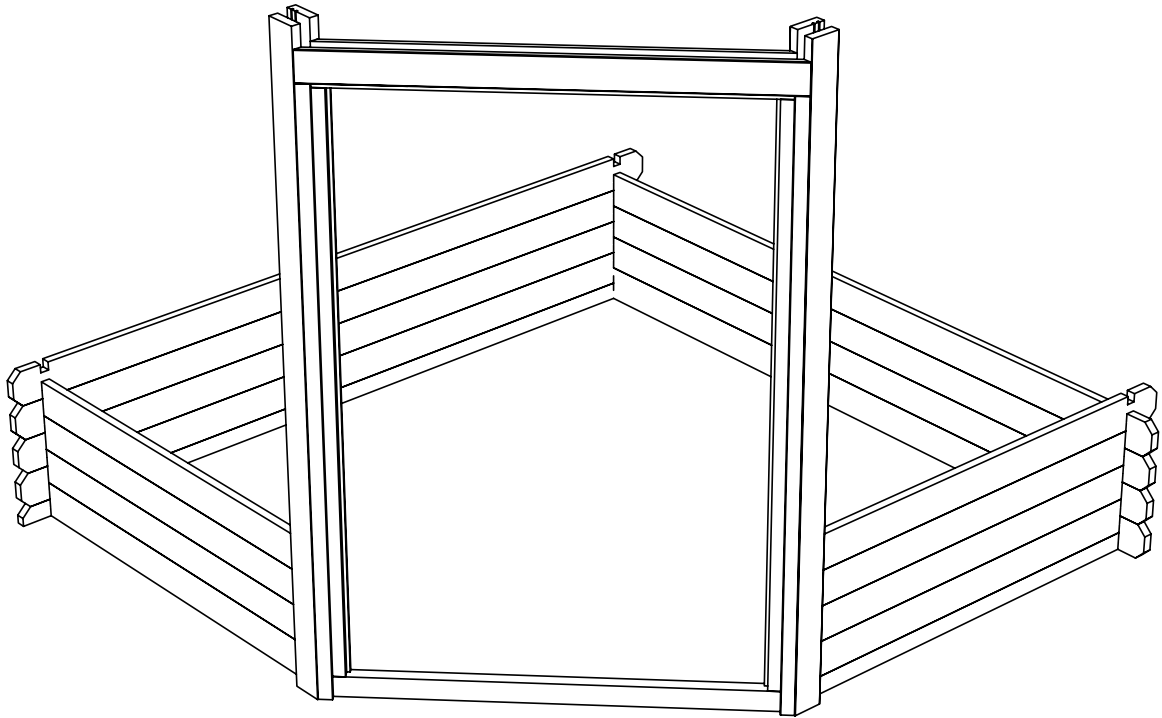

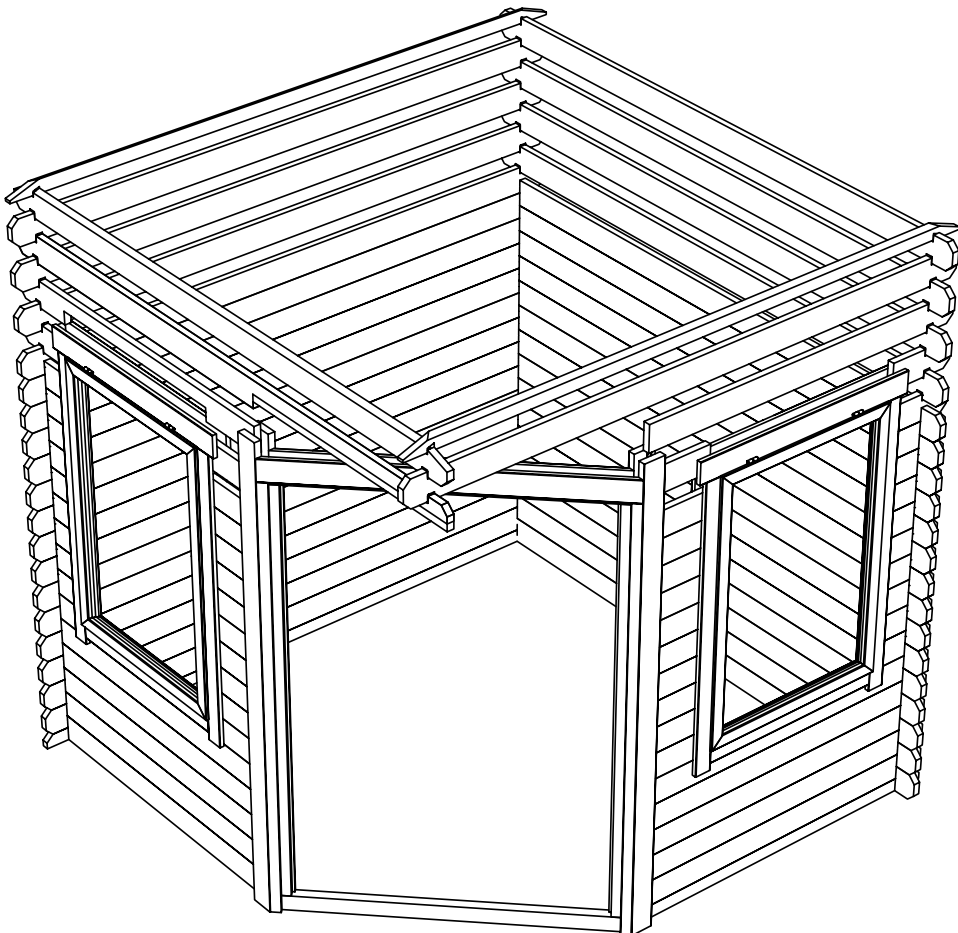
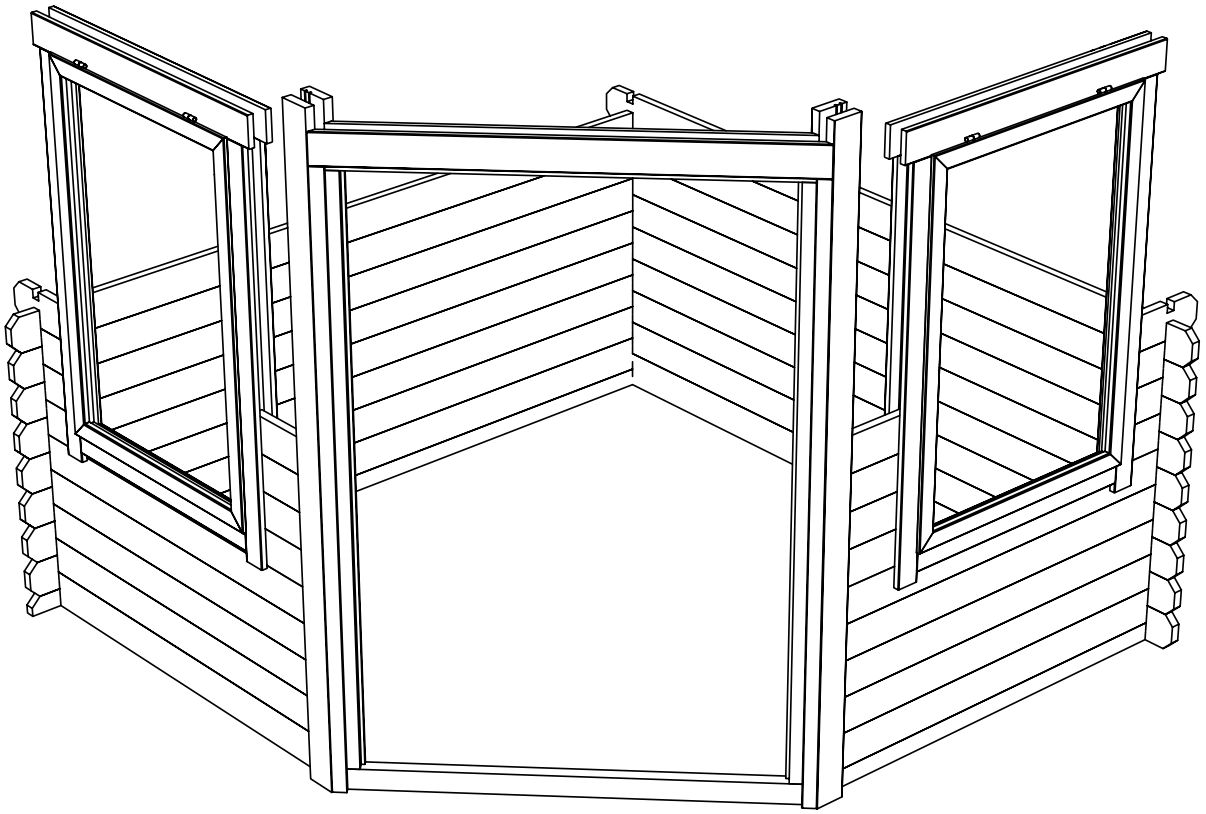

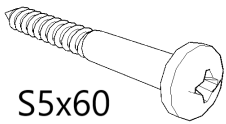
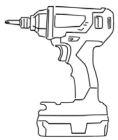
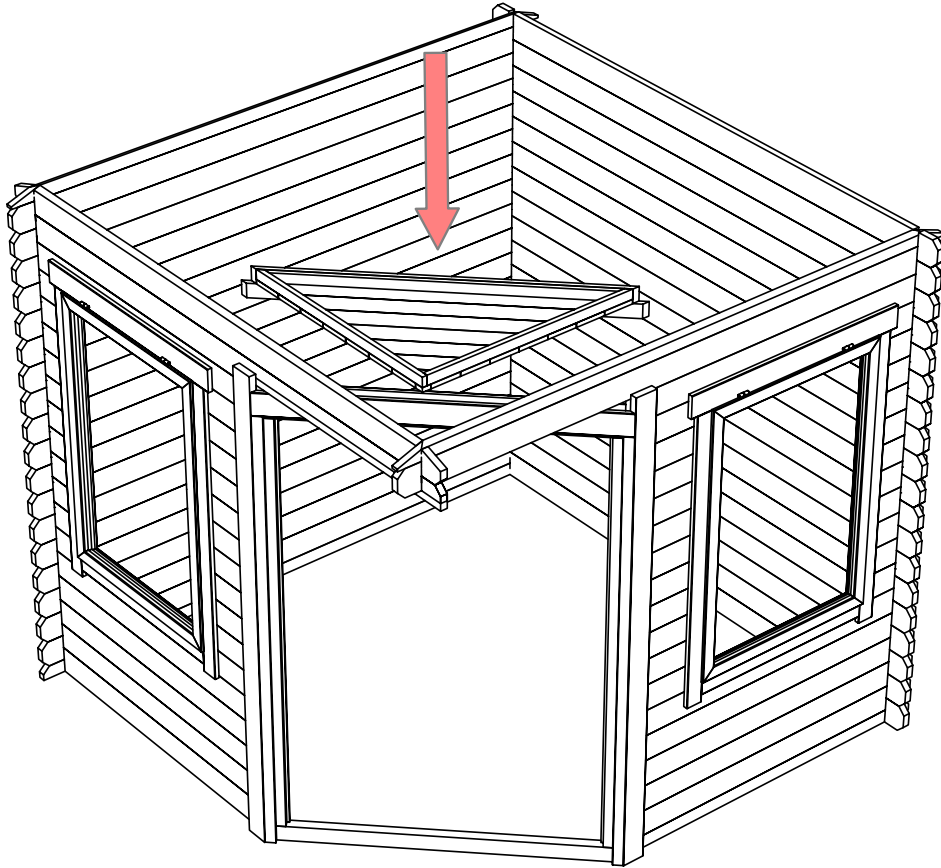

S5x60

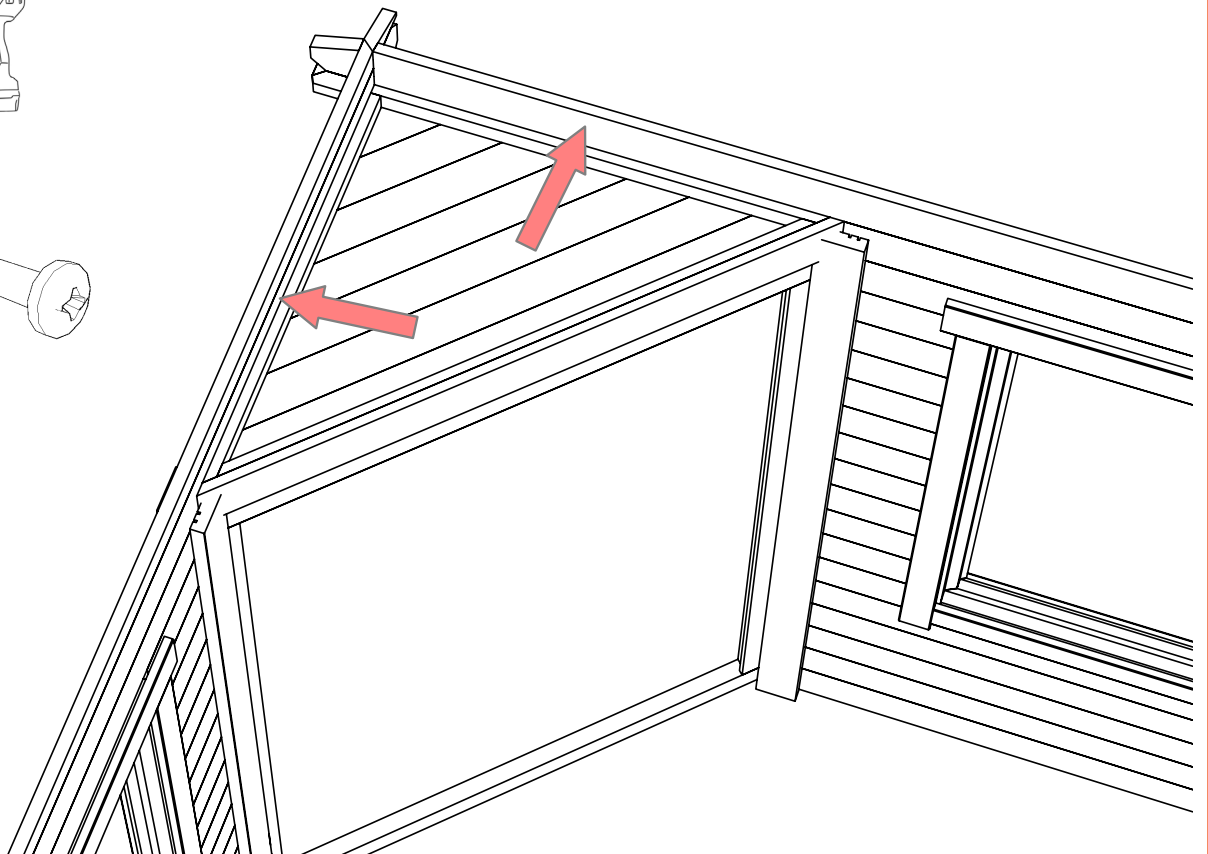

**5**

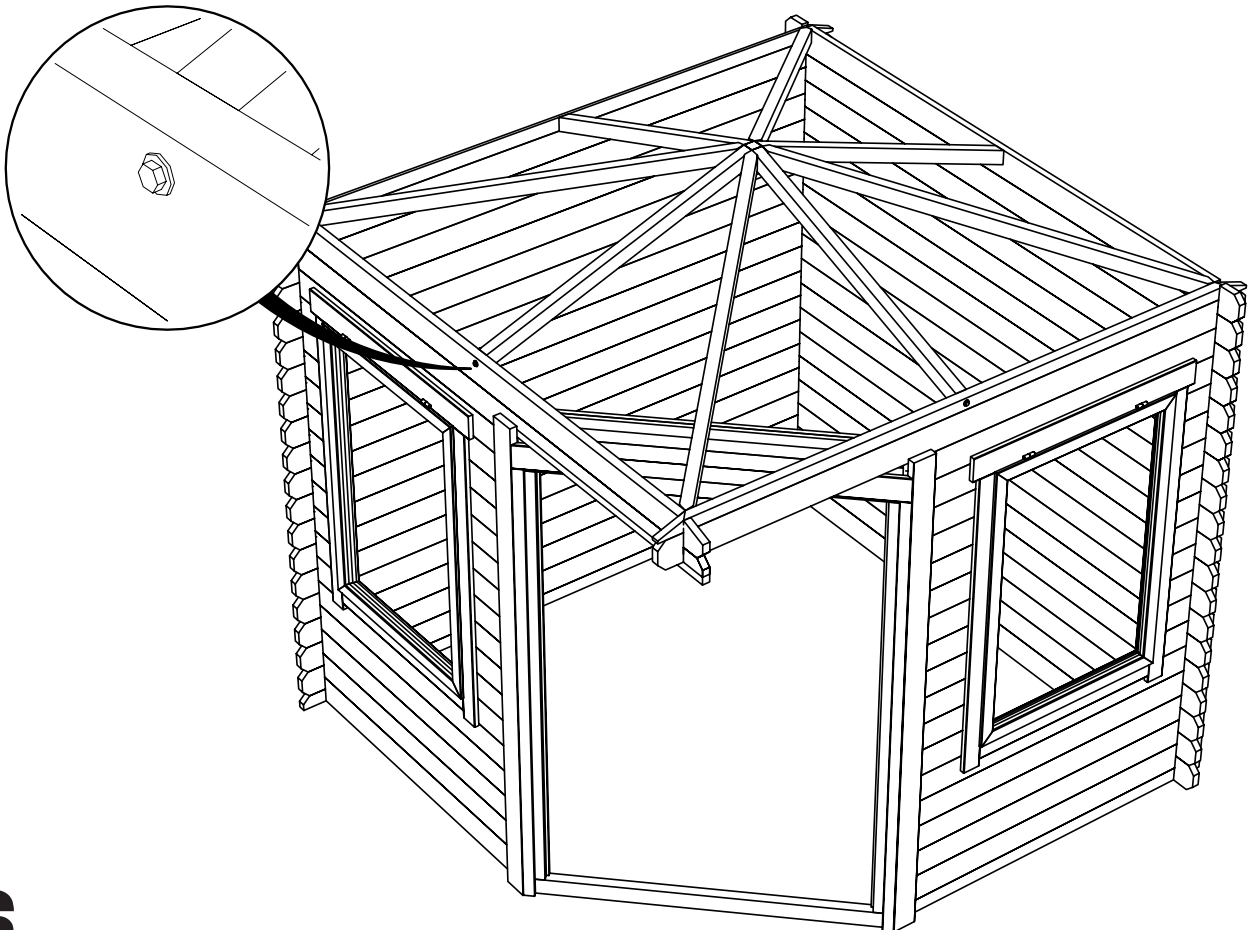
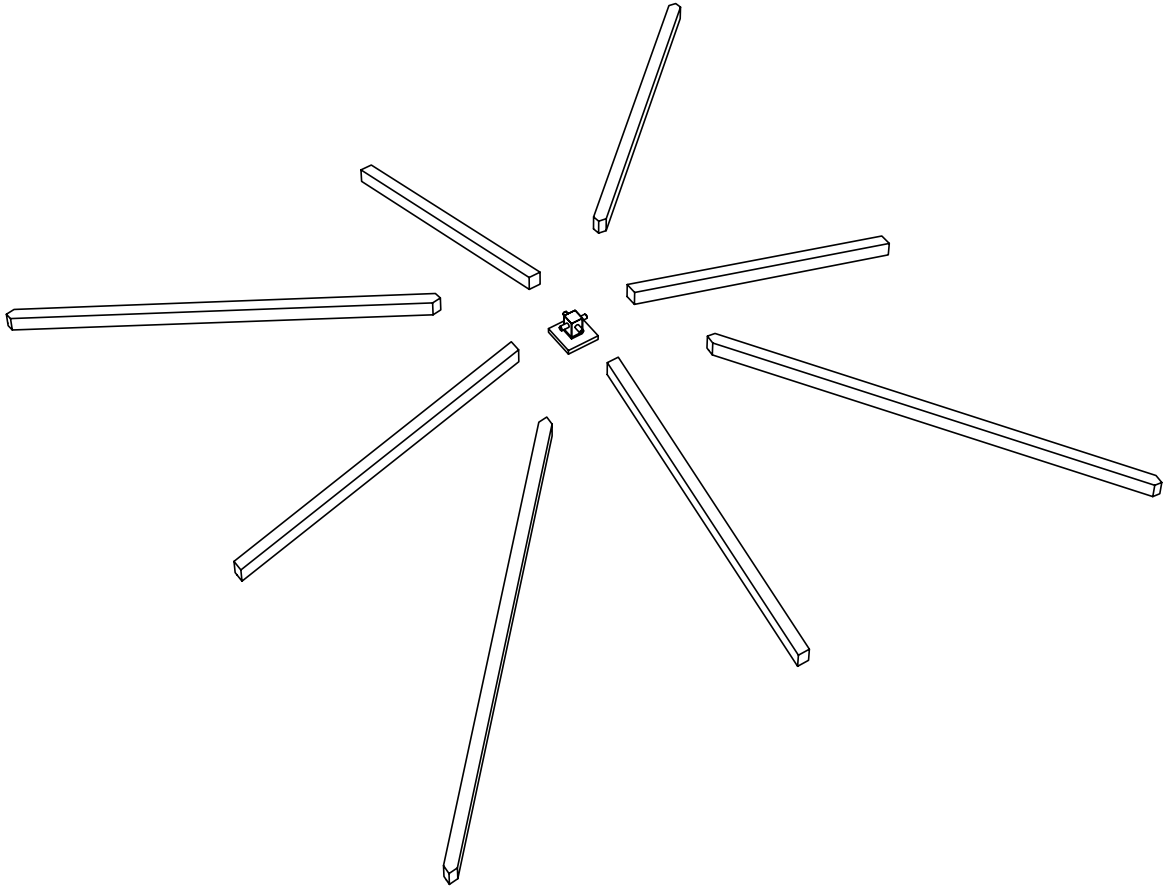



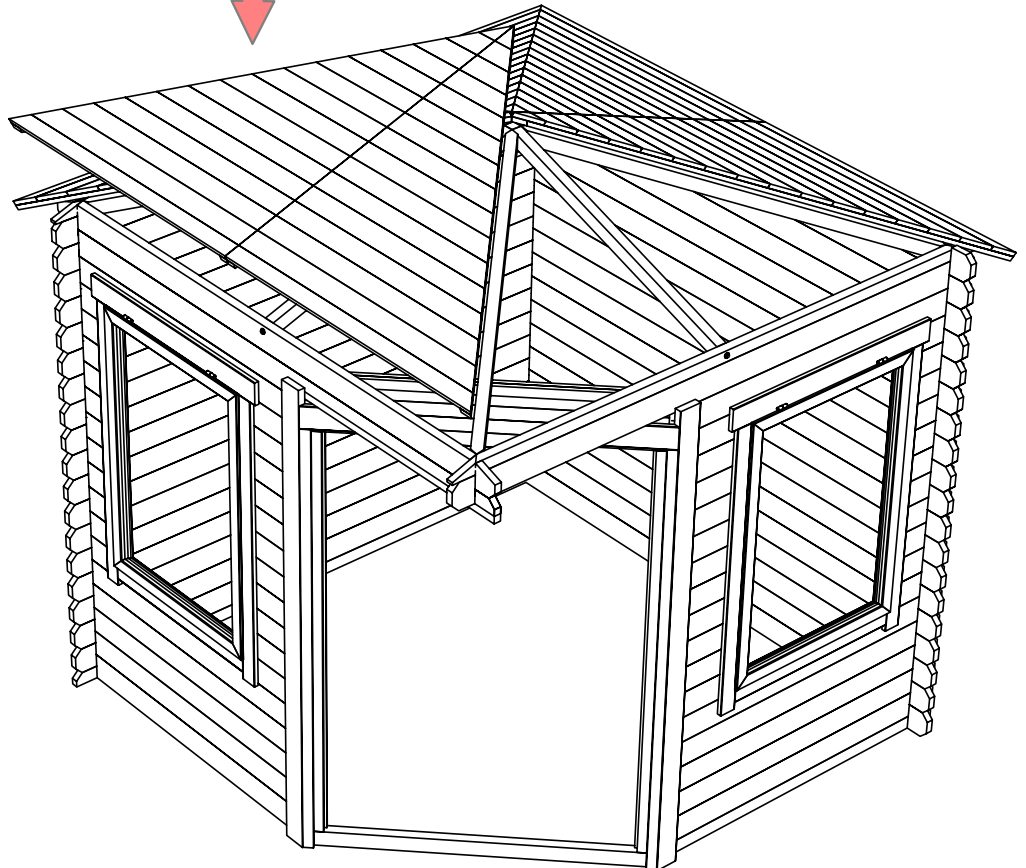
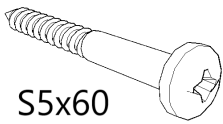
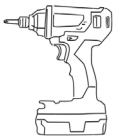
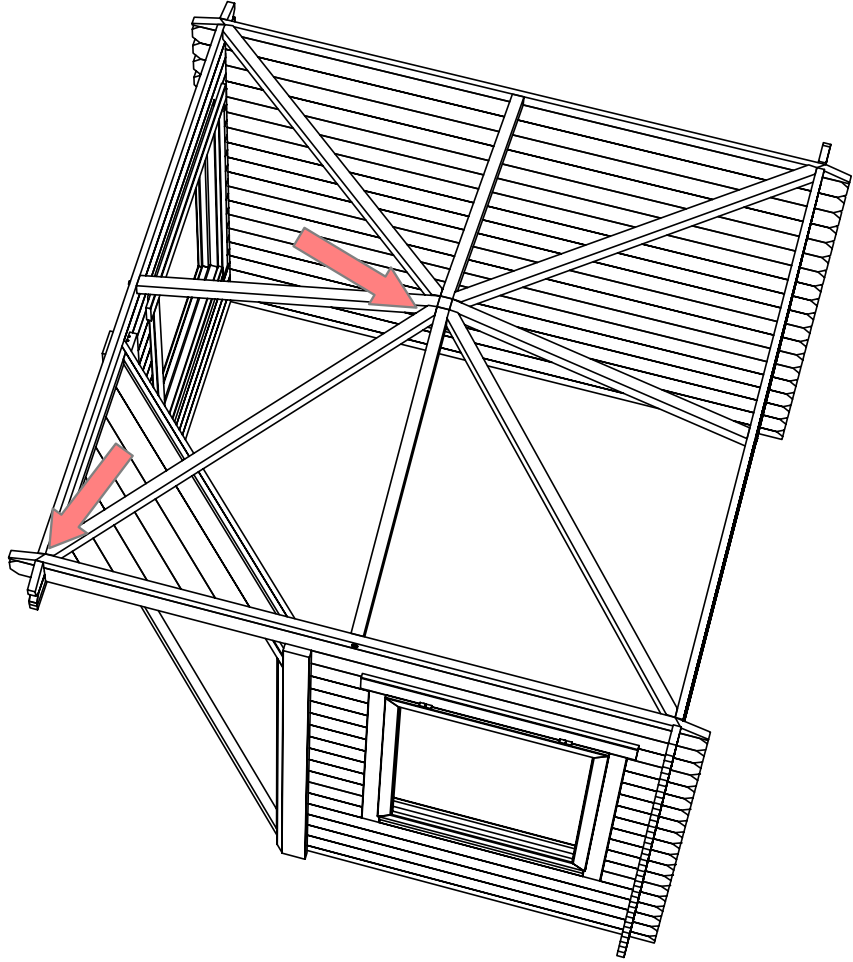
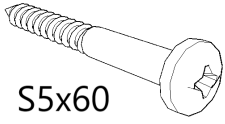
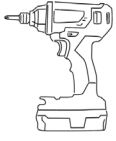

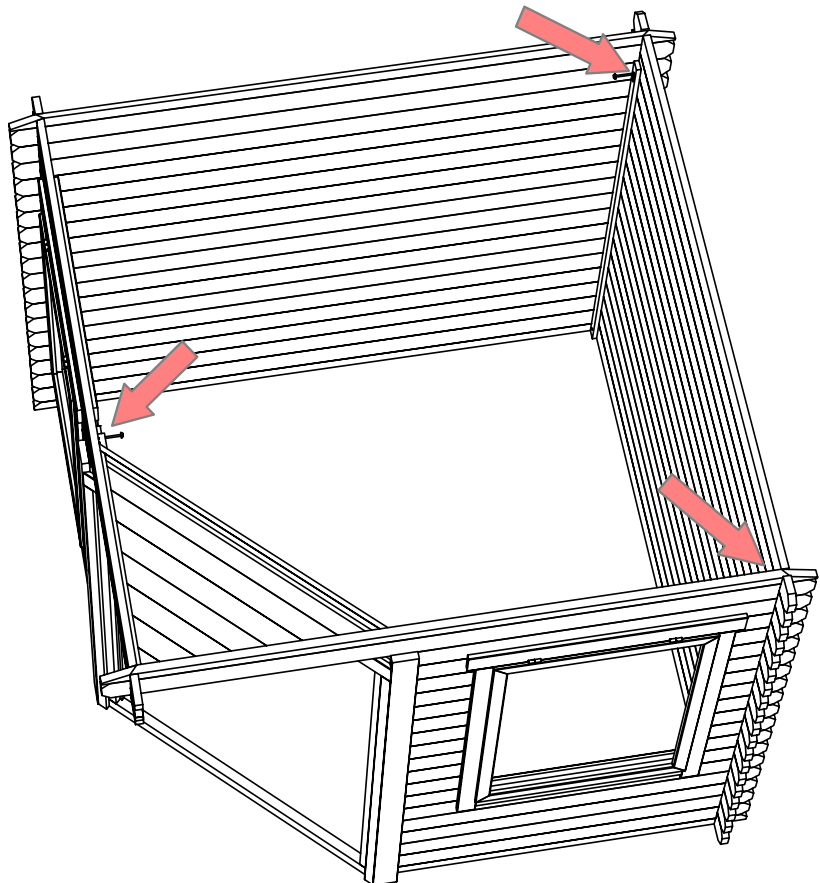
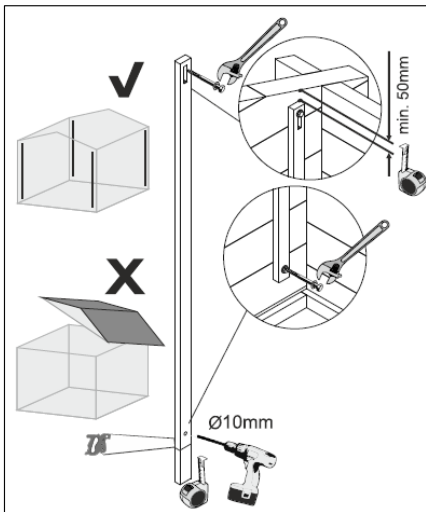
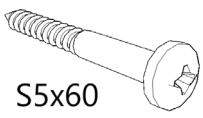
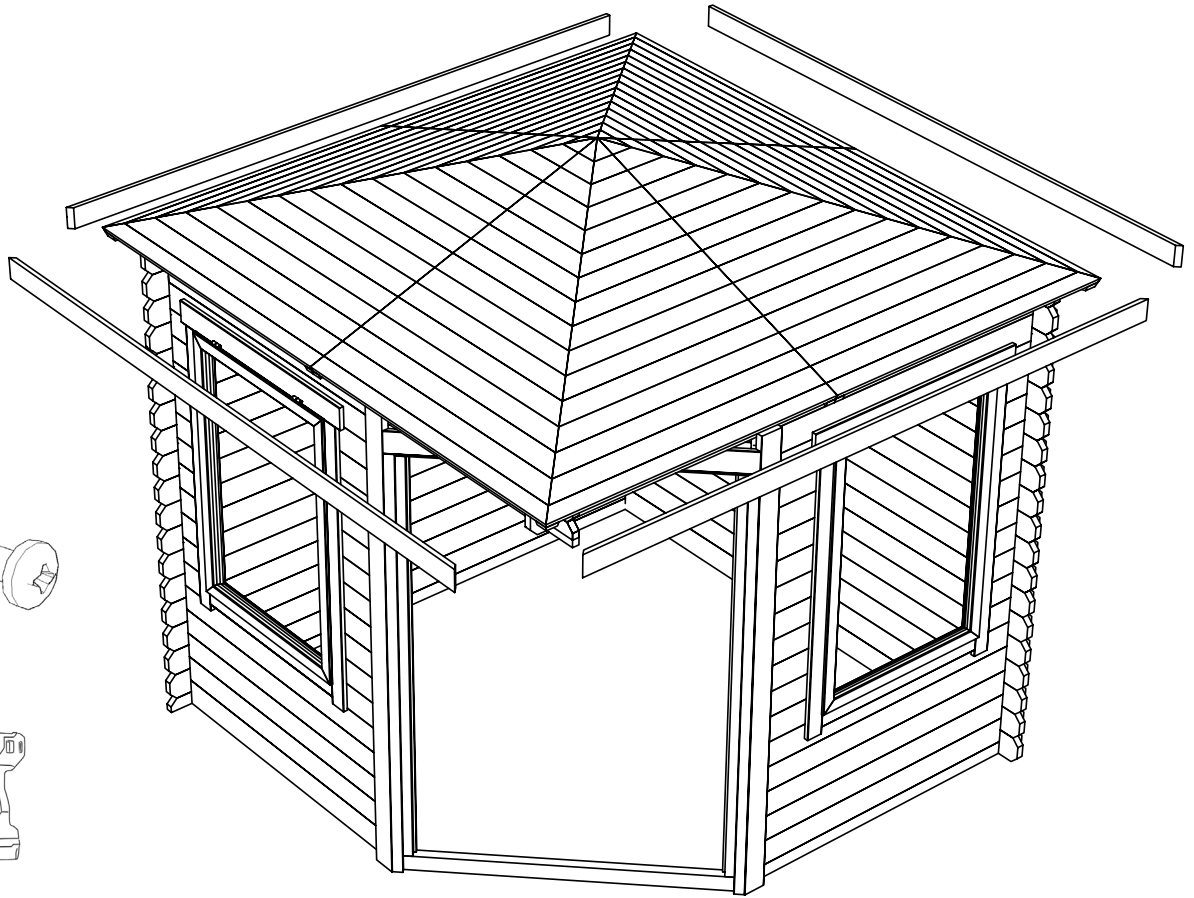

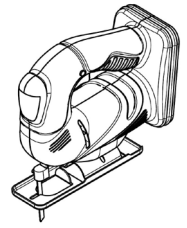
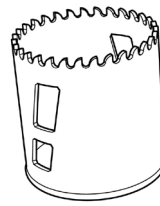
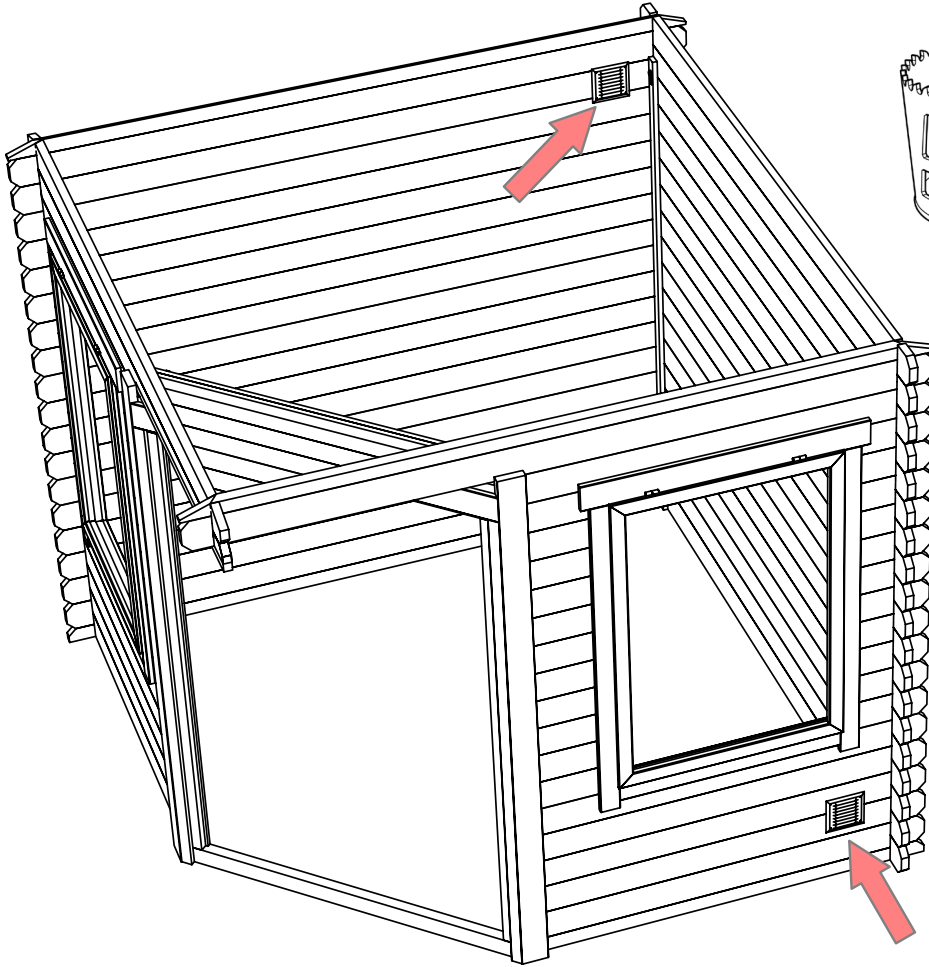

Ø ca 130mm

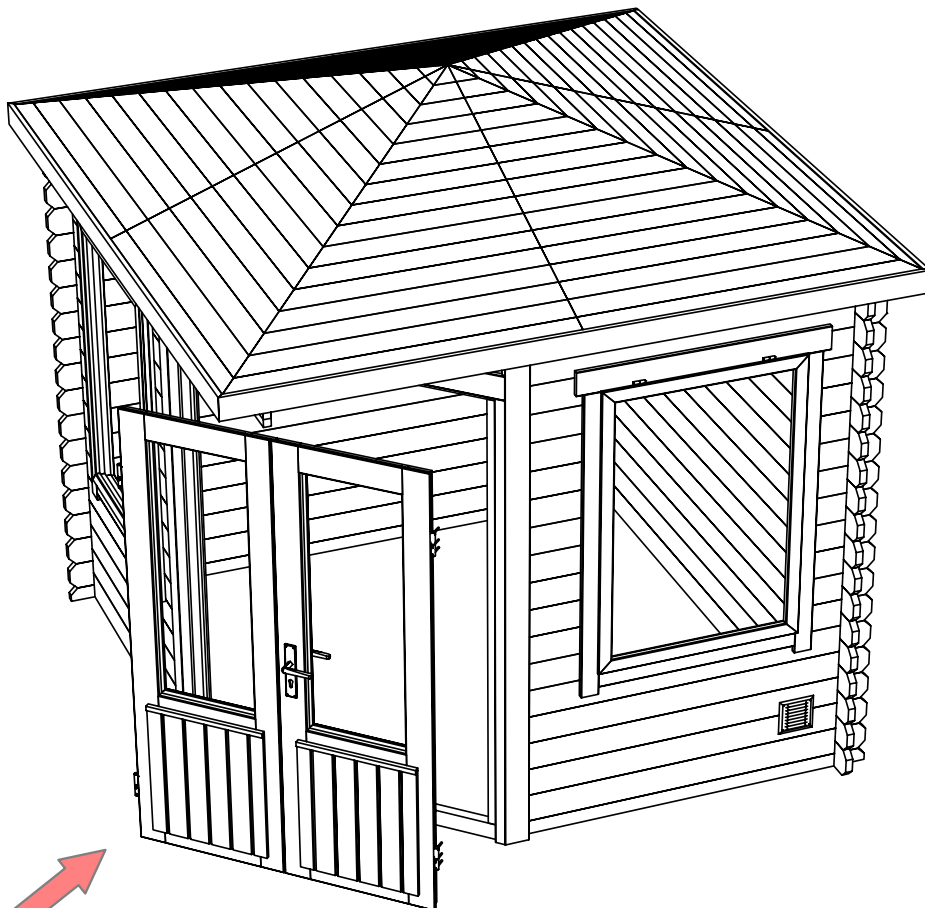
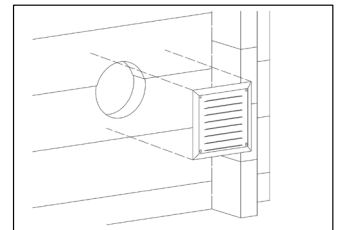
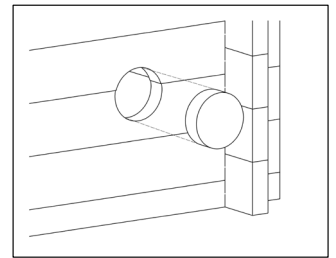

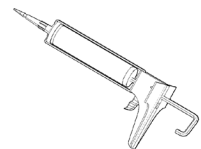
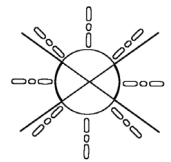
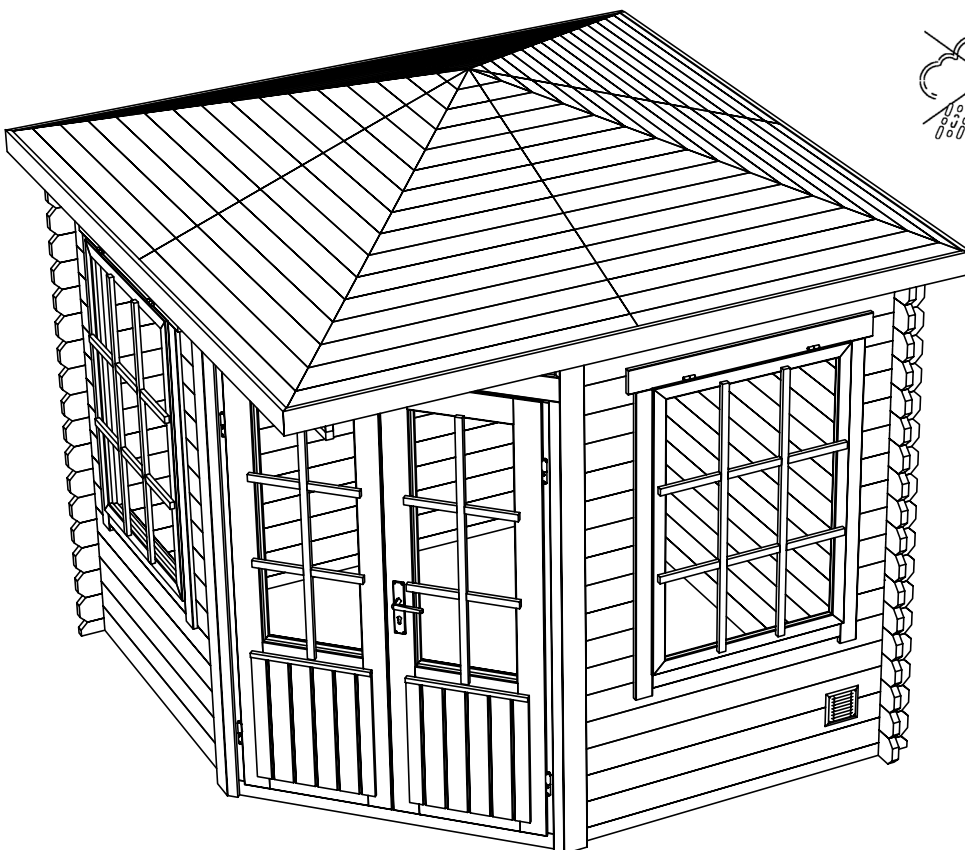
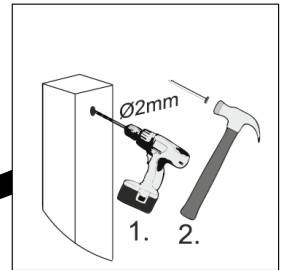
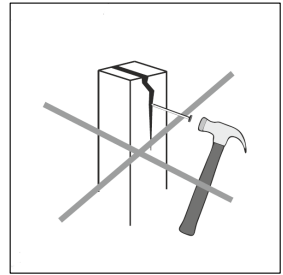
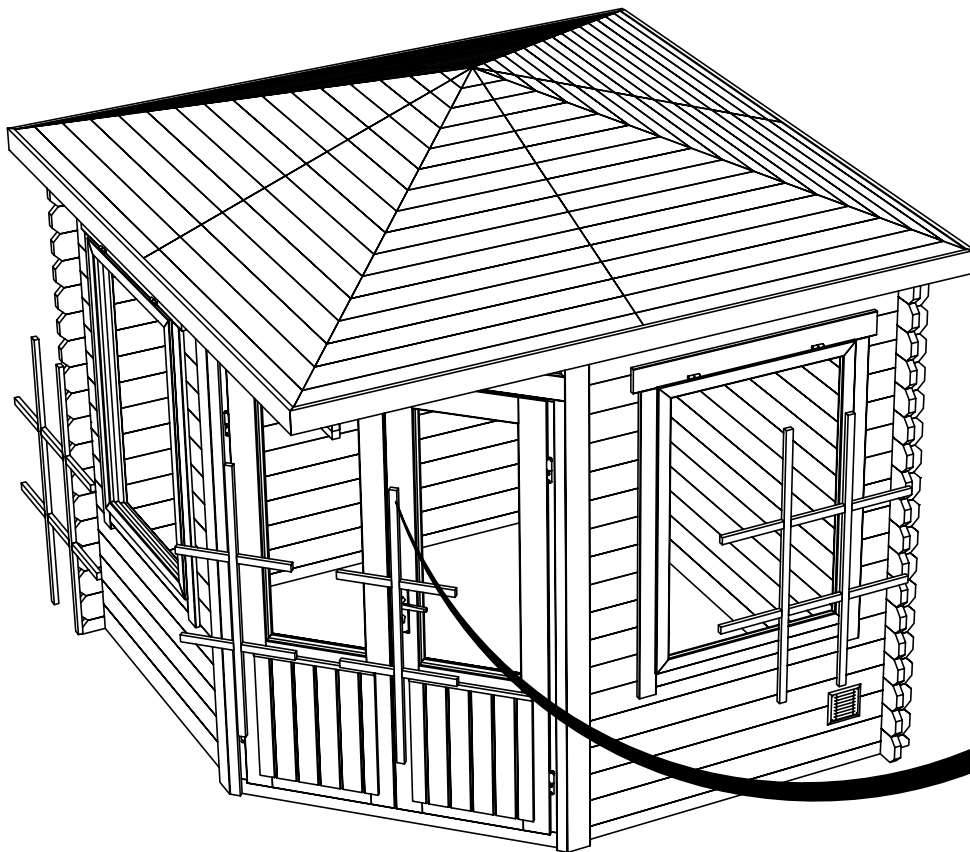

Öffnung/Opening



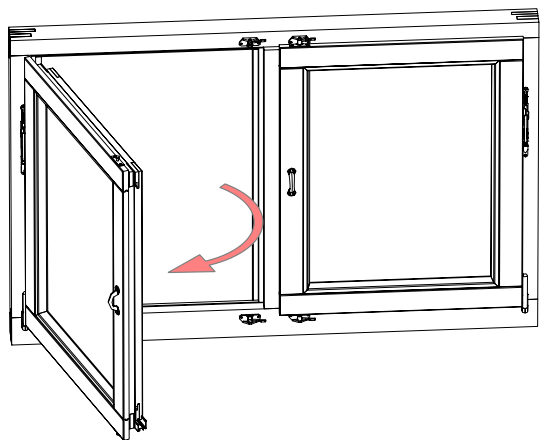
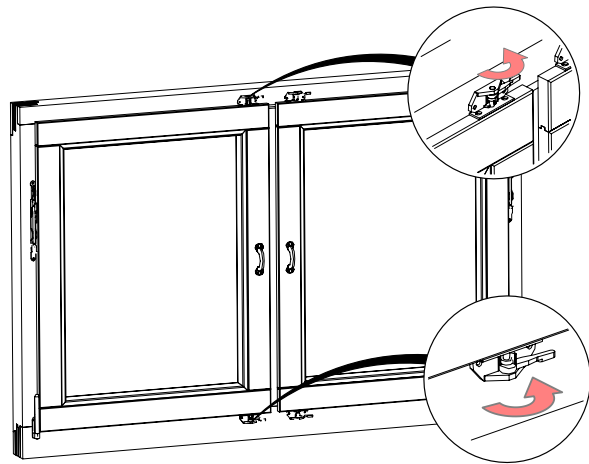



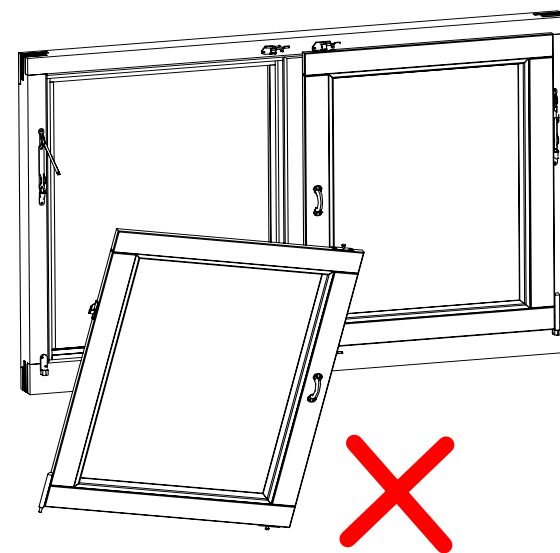
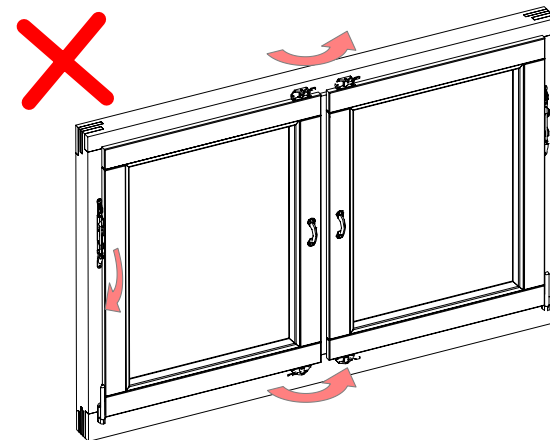
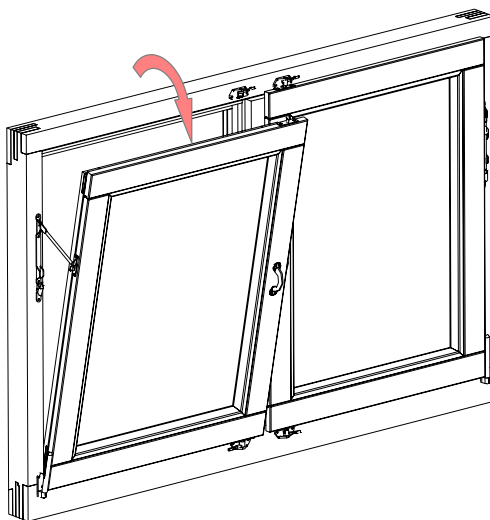
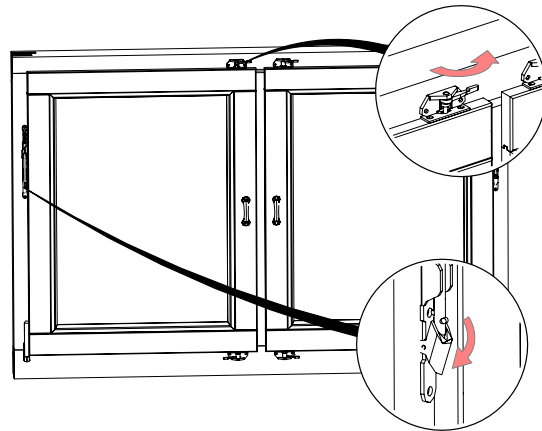

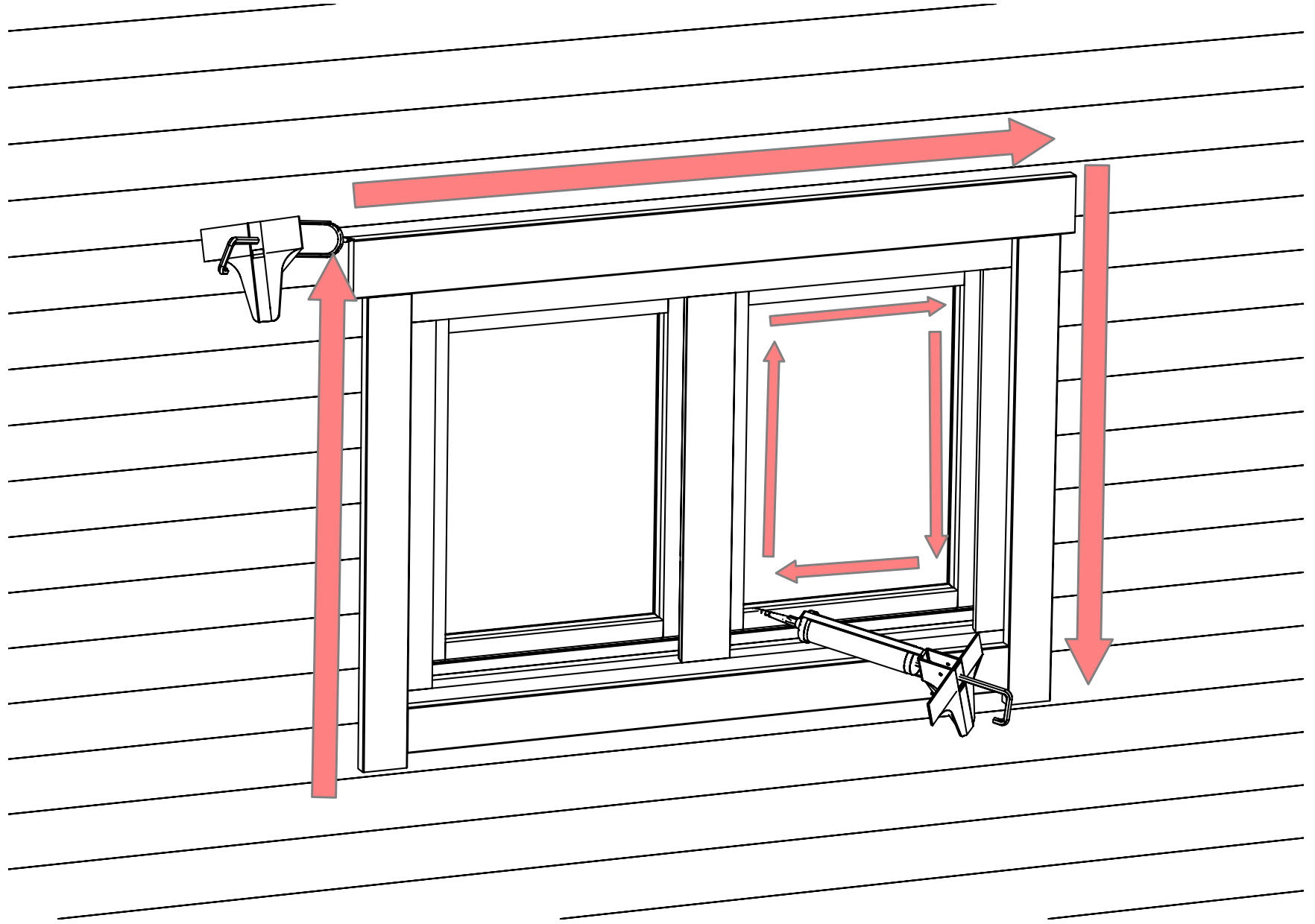
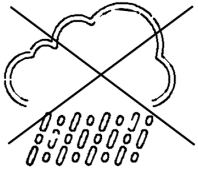
A

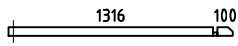
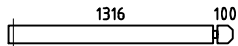

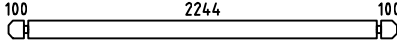
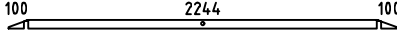
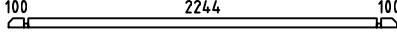
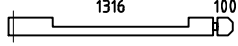
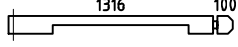
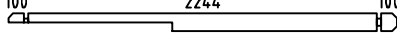
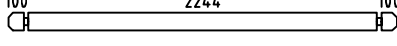
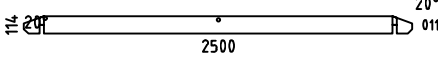
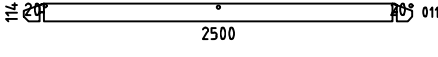
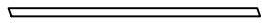
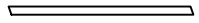
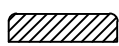
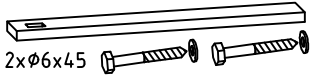

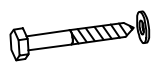

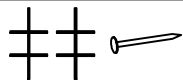

B



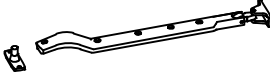
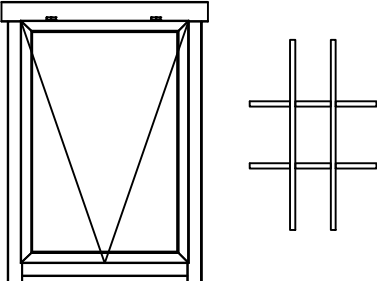
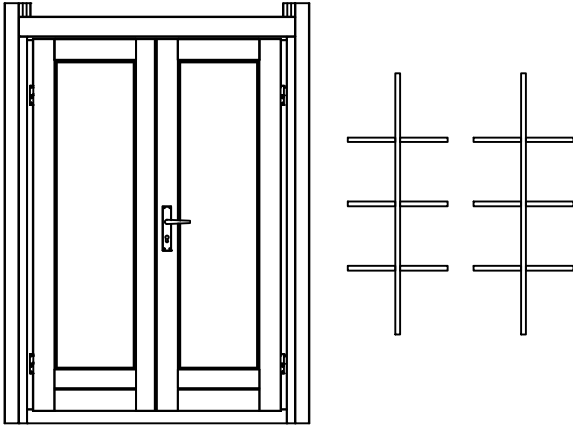
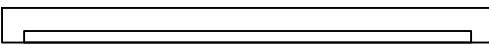
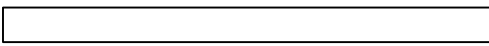
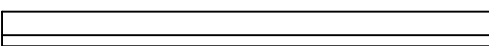

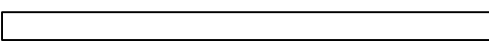
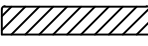
Pos	Specification-Spezifikation-Specificatie-Nomenclature-Elementi-Especificacion Sunny 28 C	Qty	Profile (mm)	Lenght (mm)
001		1	28x57	1444
002		11	28x114	1444
003		21	28x114	285
004		21	28x114	285
005		37	28x114	2500
006		2	28x57	2500
007		1	28x57	2500
008		1	28x114	1444
009		1	28x114	1444
010		1	28x114	2500
EXTRA		1	28x114	2500
WA-1		1		
WB-1		1		
RT1	RAFTER-SPARREN-DAKSPAR-CHEVRON-TRAVE-CABRIO 	4	44x55	1621
RT2	RAFTER-SPARREN-DAKSPAR-CHEVRON-TRAVE-CABRIO 	4	44x55	1192
GB-1	Gable board 70-Giebelblende-Gevelplank-Planche de rive-Tavola di bordo-Tabla de borde 	4	18x70	2750
SS-1	Storm slat kit-Sturmleiste satz-Stormanker set-Kit de latte anti tempête-Kit listello di tempesta-Kit liston anti tormenta 	3	18x40	2000
CET1	Ceiling element 2-Deckenelement-Plafond element-Panneau de plafond-Pannelo da soffitto-Panel de techo 	1	876x1173	
C8x80	Coach screw kit 8x80-Holzschraube-Houtdraadbout-Tirefond-Vite tirafondo-Tornillo entrenador 	4	8x80	
	Double door kit-Doppeltür satz-Dubbele deur set-Kit double porte-Kit porta-Kit para puerta 	1		
	Nail 1.6x30-Nagel-Spijker-Clou-Chiodo-Clavo 	35	1.6x30	
RPC	Ridge piece-Firstelement-Nokstuk-Faitage-Colmo-Cumeeira 	1		
RP1	Roof panel 1-Dach elemente-Dakpanelen-Panneau de toit-Pannelo da tetto-Panel de tejado 	4+4	1445x1347	
Kood	Sunny 28 C	Materjal	File Sunny 28 C.dwg	Leht 1/2

Pos	Specification-Spezifikation-Specificatie-Nomenclature-Elementi-Especificacion Sunny 28 C	Qty	Profile (mm)	Lenght (mm)		
S4x60	Screw 4x60-Schraube-Schroef-Vis-Vite-Tornillo 	80	4x60			
	Ventilation panel kit-Außengitter-Schoepenrooster-Panneau de ventilation-Griglia di ventilazione-Rejilla de ventilacion 	1				
	Window stay-Fensterfeststeller-Raamuitzetter-Limiteur d'ouverture fenêtre-Vento bretelle-Soporte de ventana 	2				
	WINDOW 865x1225 W0-9N 865x1225-28 	2				
	DOOR 1272x1891 DD08-8P 1272x1891-28 	1				
	CORNER DOOR SET					
1	Top Jamb 	1	58x42	1272		
2	Threshold 	1	58x42	1272		
3-4	Vertical Jamb 	2	58x42	1781		
5-6	Post Set 	1+1	42x61	2020		
7-8	Cover Slat 	2	40x18	1860		
9-10	Casting 	2	18x95	1500		
S4x60	Screw 4x60-Schraube-Schroef-Vis-Vite-Tornillo 	16	4x60			
S5x90	Screw 5x90-Schraube-Schroef-Vis-Vite-Tornillo 	16	5x90			
Kood	Sunny 28 C	Materjal	File	Sunny 28 C.dwg	Leht	2/2



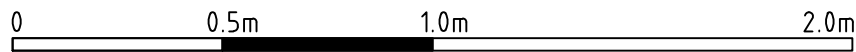
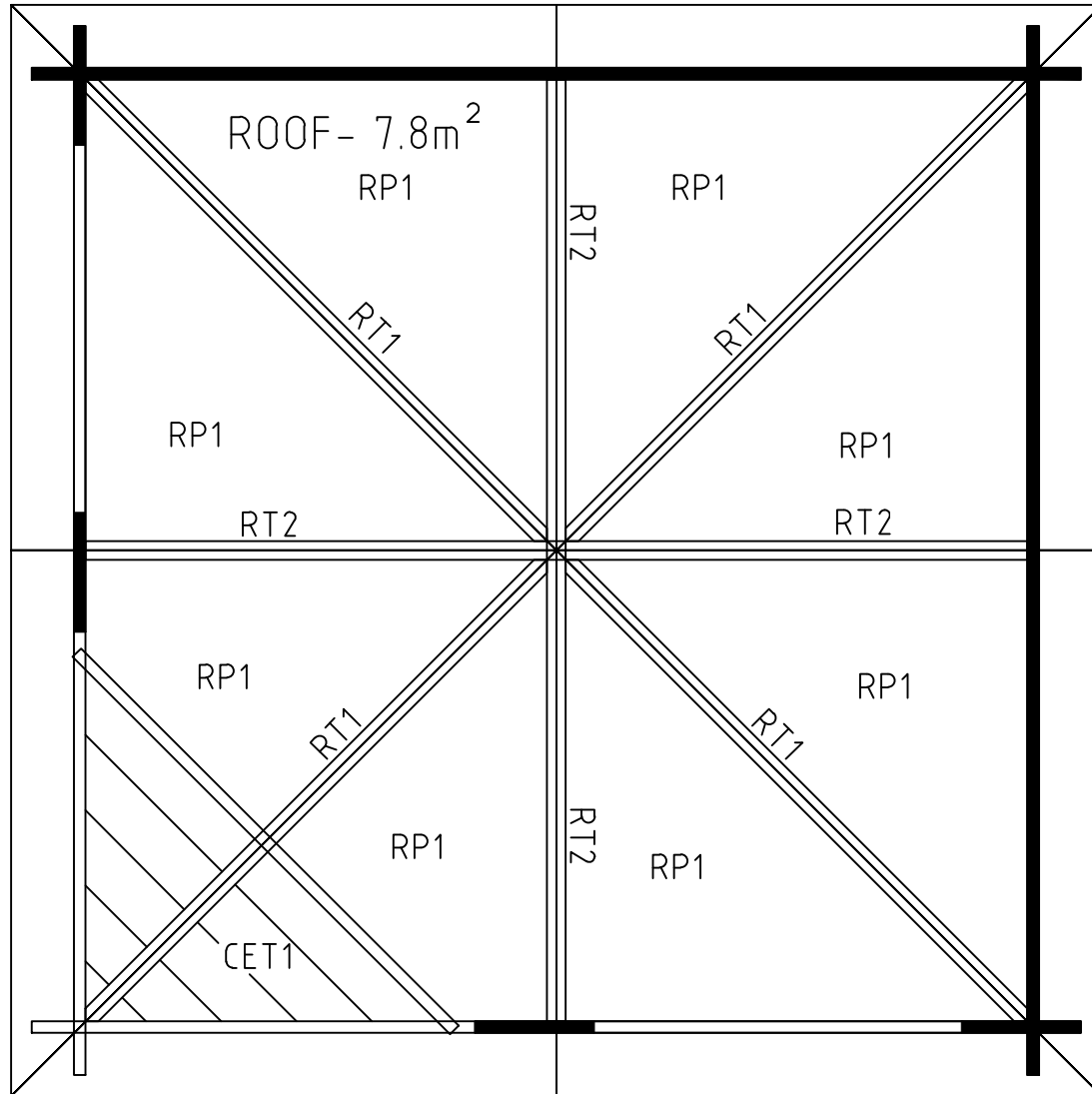

Model	Sunny 28 C	Drawing	ROOF	Page		
	Drawn by	J.S	Material	28x114	Scale	1:20
	Date	25.05.2023	File	Sunny 28 C.dwg		

H = 1.500 m  
TOTAL: 4.65 m<sup>2</sup>

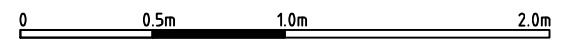
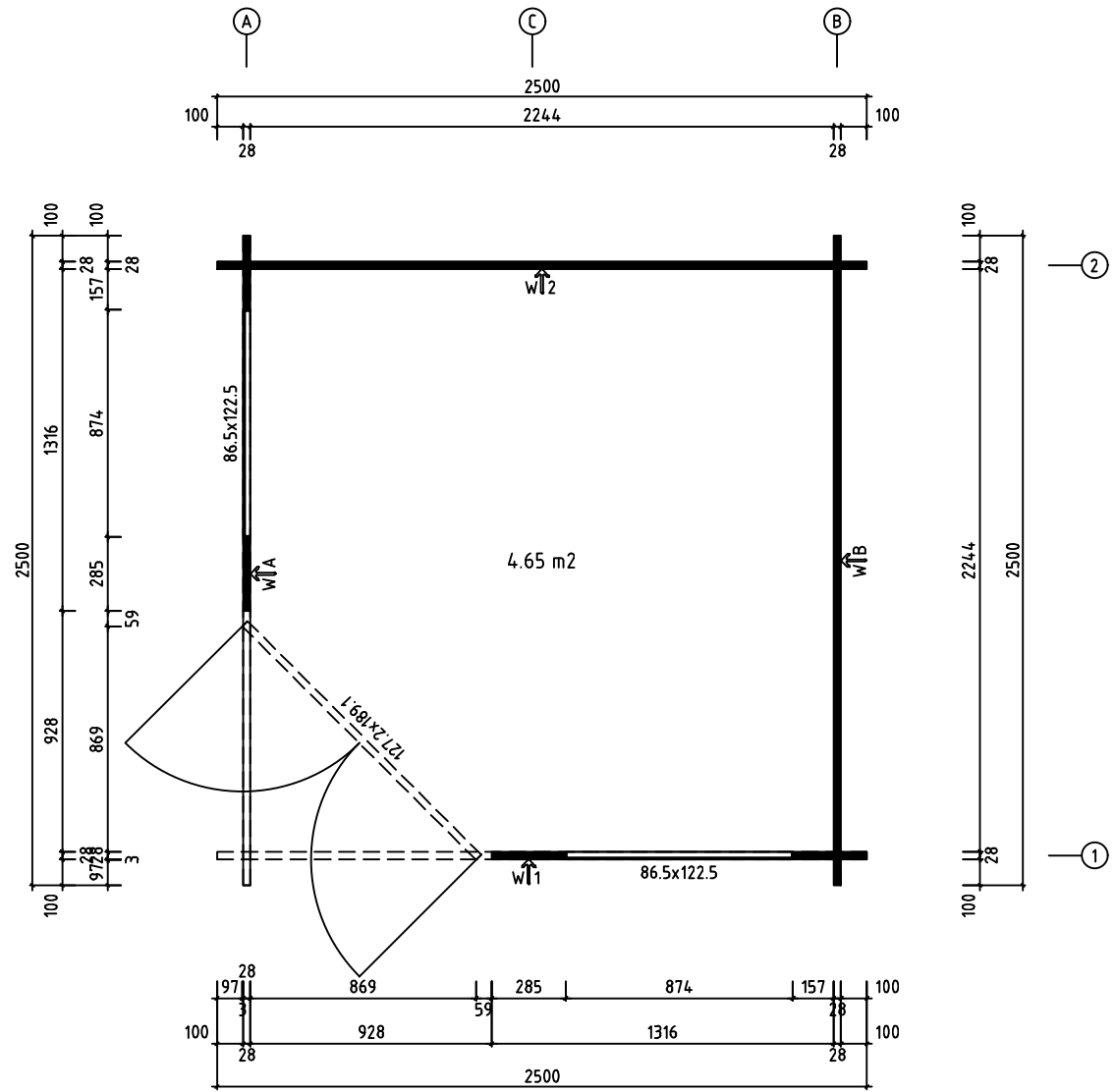

Model	Sunny 28 C		Drawing	PLAN	Page			
			Drawn by	J.S	Material	28x114	Scale	1:20
			Date	25.05.2023	File	Sunny 28 C.dwg		

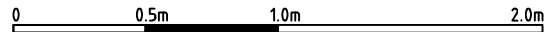
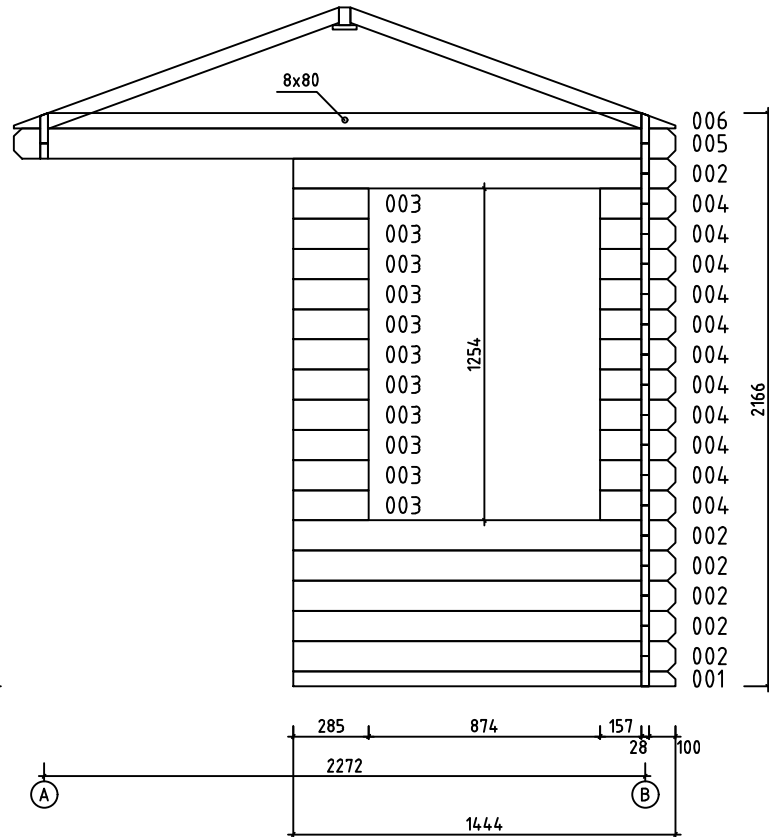

Model	Sunny 28 C	Drawing	WALL 1	Page	5
		Drawn by	J.S	Material	2.8x11.4
		Date	25.05.2023	File	Sunny 28 C.dwg



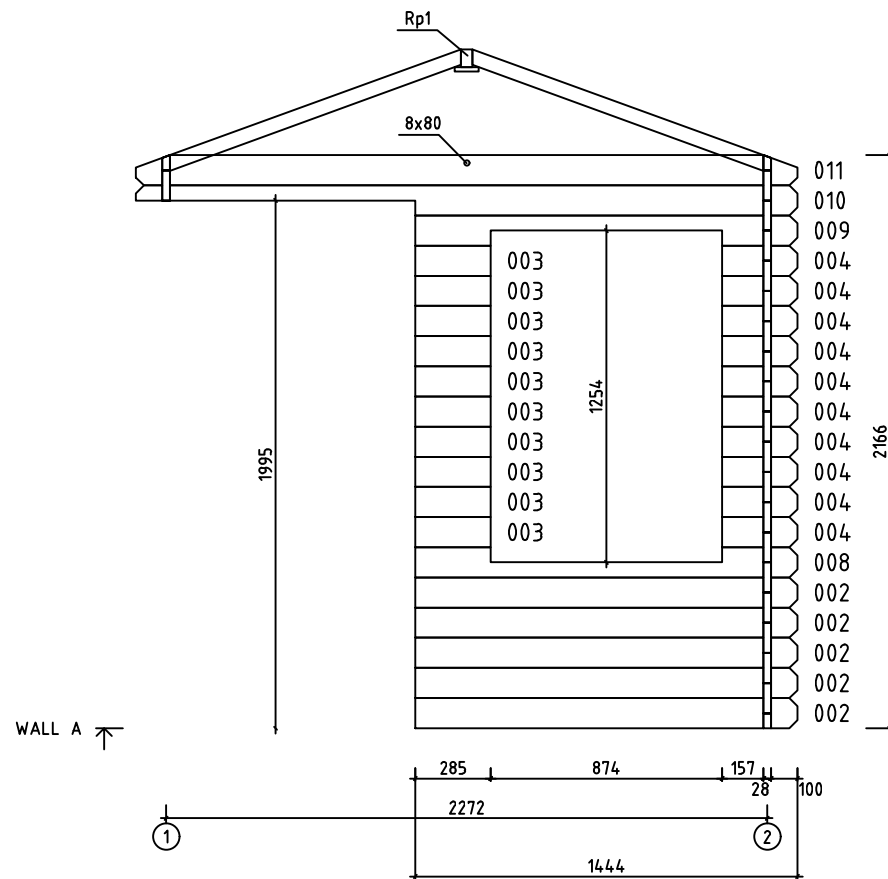

0 0.5m 1.0m 2.0m

Model	Sunny 28 C	Drawing	WALL A	Page	2
		Drawn by	J.S	Material	2.8x11.4
		Date	25.05.2023	File	Sunny 28 C.dwg

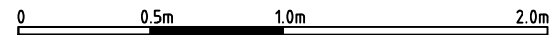
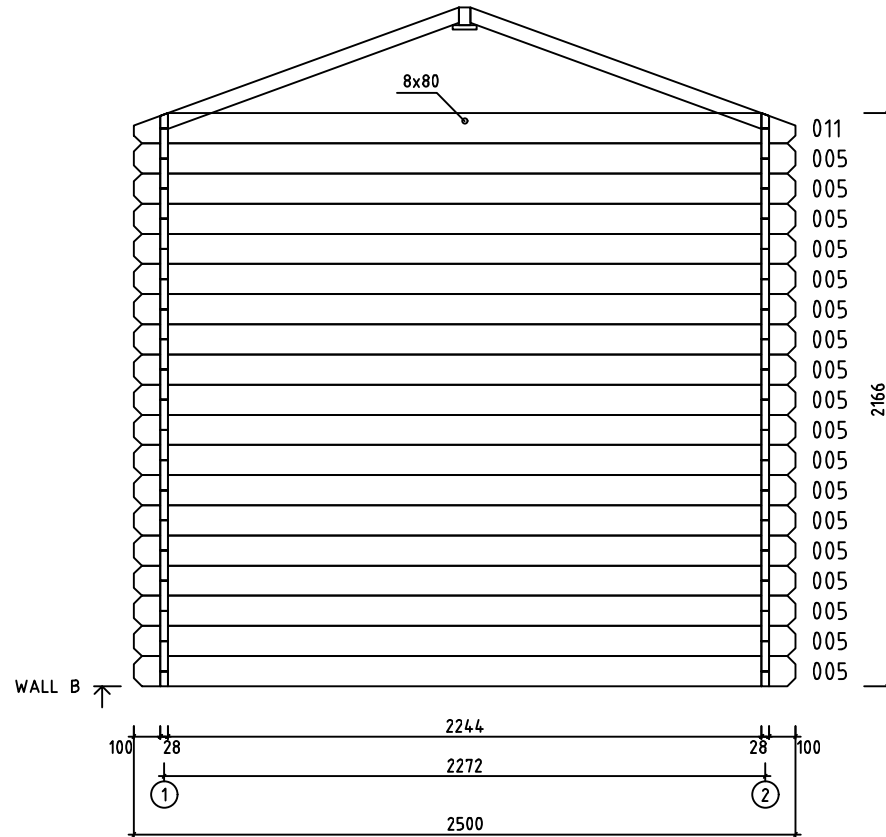

Model	Sunny 28 C	Drawing	WALL B	Page	3
		Drawn by	J.S	Material	2.8x11.4
		Date	25.05.2023	File	Sunny 28 C.dwg
		Scale	1:20		